

Data sheet | Item number: 253-103

2-conductor PCB terminal block; 1.5 mm²; Pin spacing 5 mm; 3-pole; PUSH WIRE®

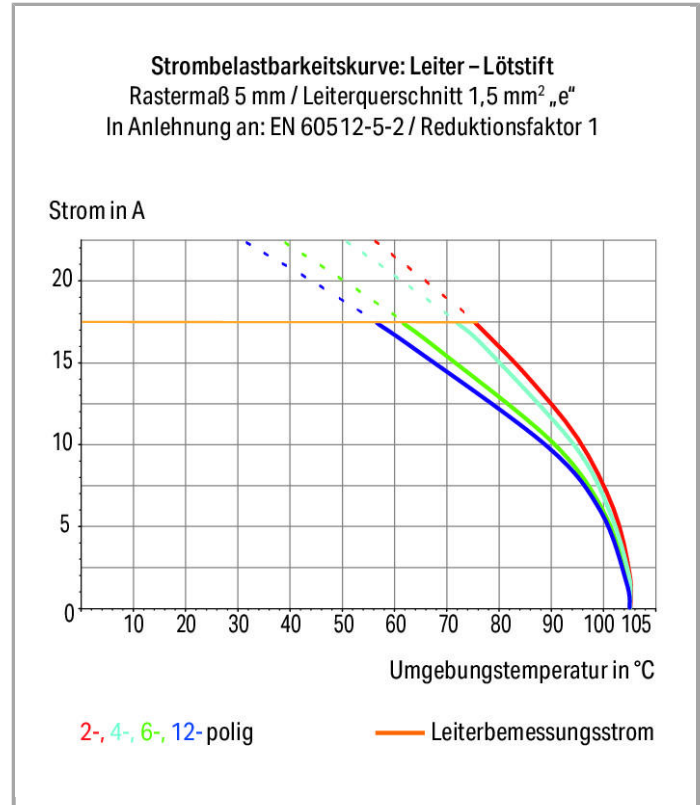

www.wago.com/253-103

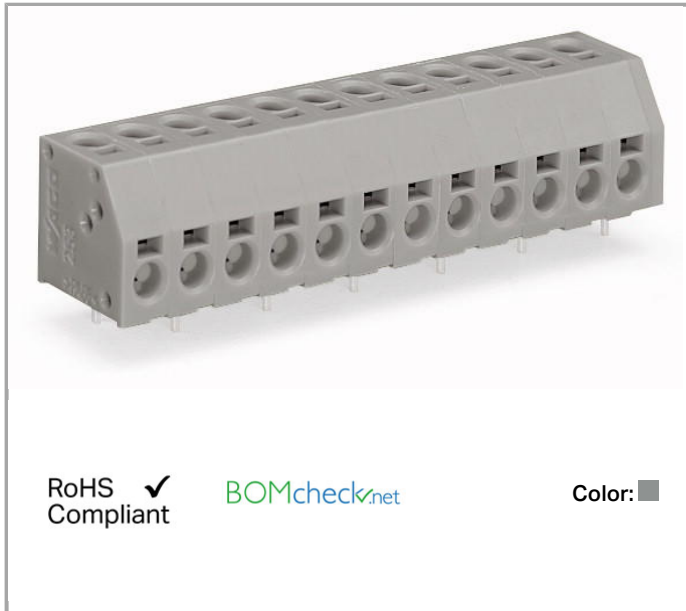

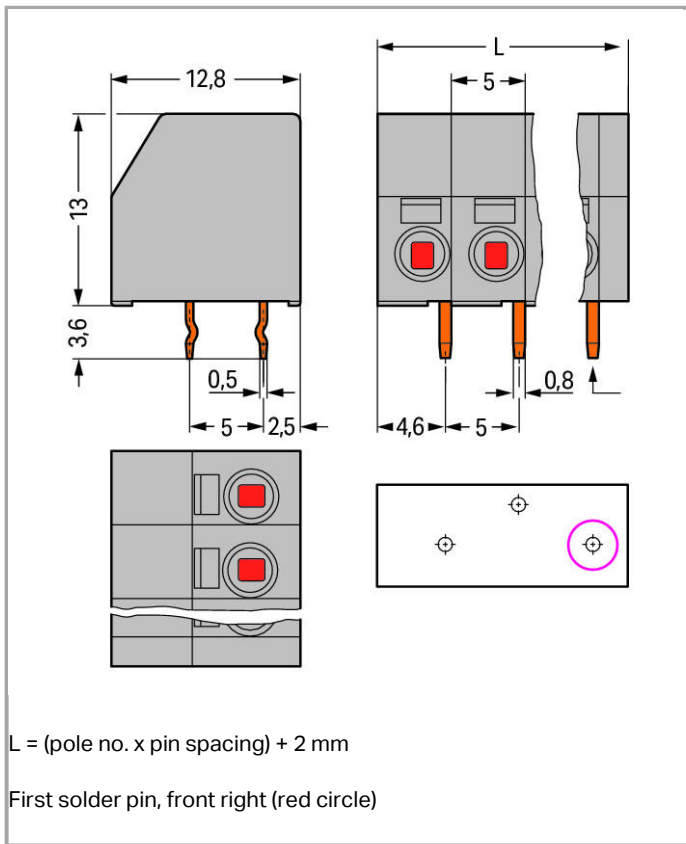

Item description

- PCB terminal strips with PUSH WIRE® connection and screwdriver actuation
- Double-conductor connection provides top-entry (vertical) and/or side-entry (horizontal) wiring
- Push-in termination of solid conductors
- Double entries for power supply and potential distribution

Other variants can be requested via the WAGO sales department or, if necessary, configured at <https://configurator.wago.com/>: Direct marking, Mixed-color terminal strips, Other colors, Other pole numbers

Data

Electrical data

Ratings per IEC/EN 60664-1

Rated voltage (III / 3)	320 V
Rated impulse voltage (III / 3)	4 kV
Rated voltage (III / 2)	320 V
Rated impulse voltage (III / 2)	4 kV
Rated voltage (II / 2)	630 V
Rated impulse voltage (II / 2)	4 kV



Rated current	17.5 A
Legend (ratings)	(III / 2) $\hat{=}$ Overvoltage category III / Pollution degree 2

Approvals per UL 1059

Rated voltage UL (Use Group B)	300 V
Rated current UL (Use Group B)	8 A
Rated voltage UL (Use Group D)	300 V
Rated current UL (Use Group D)	8 A

Approvals per CSA

Rated voltage CSA (Use Group B)	300 V
Rated current CSA (Use Group B)	8 A
Rated voltage CSA (Use Group D)	300 V
Rated current CSA (Use Group D)	8 A

Connection data

Connection type (1)	PUSH WIRE® connection
Connection technology	PUSH WIRE®
Number of connection points (connection type)	1
Actuation type	Operating tool
Solid conductor	0.5 ... 1.5 mm ² / 20 ... 16 AWG
Strip length	8.5 ... 9.5 mm / 0.33 ... 0.37 Inch
Note (strip length)	7 ... 8 mm / 0.28 ... 0.31 in. (for wiring on both sides)
Conductor entry angle to the PCB	0°
Connection type (2)	PUSH WIRE® connection
Connection technology 2	PUSH WIRE®
Number of connection points	1
Solid conductor (2)	0.5 ... 1.5 mm ² / 20 ... 16 AWG
Strip length (2)	8.5 ... 9.5 mm / 0.33 ... 0.37 Inch
Note (strip length) 2	7 ... 8 mm / 0.28 ... 0.31 in. (for wiring on both sides)
Conductor entry angle to the PCB 2	90°
No. of poles	3
Total number of connection points	6
Total number of potentials	3
Number of connection types	2
Number of levels	2

Geometrical Data

Pin spacing	5 mm (0.197 inch)
-------------	-------------------

Width	17 mm / 0.669 inch
Height	16.6 mm / 0.654 inch
Height from the surface	13 mm / 0.512 inch
Depth	12.8 mm / 0.504 inch
Solder pin length	3.6 mm
Solder pin dimensions	0.5 x 0.8 mm
Drilled hole diameter (tolerance)	1.1 ^(+0.1) mm

PCB contact

PCB contact	THT
Solder pin arrangement	over the entire terminal strip, staggered
Number of solder pins per potential	1

Material Data

Color	gray
Material group	I
Insulating material	Polyamide 66 (PA 66)
Flammability class per UL94	V0
Clamping spring material	Chrome nickel spring steel (CrNi)
Contact material	Electrolytic copper (Ecu)
Contact plating	tin-plated
Fire load	0.061 MJ
Weight	2.854 g

Environmental Requirements

Limit temperature range	-60 ... +105 °C
-------------------------	-----------------

Commercial data

Country of origin	CN
GTIN	4044918689205
Customs Tariff No.	85369010000
Product Group	4 (Printed Circuit)

Approvals / Certificates

Country specific Approvals

Logo	Approval	Certificate name
	CCA DEKRA Certification B.V.	NTR NL-7122



	CCA DEKRA Certification B.V.	NTR NL 6580
	CCA DEKRA Certification B.V.	2126302.02
	ENEC DEKRA Certification B.V.	2160584.27
	VDE VDE Prüf- und Zertifizierungsinstitut	40028668
UL-Approvals		
Logo	Approval	Certificate name
	cURus Underwriters Laboratories Inc.	E45172 sec. 6
	UL UL International Germany GmbH	E45171

Compatible products

Marking accessories

	Item no.: 210-332/500-202 Marking strips; as a DIN A4 sheet; MARKED; 1-16 (160x); Height of marker strip: 3 mm; Strip length 182 mm; Horizontal marking; Self-adhesive	www.wago.com/210-332/500-202
	Item no.: 210-332/500-204 Marking strips; as a DIN A4 sheet; MARKED; 17-32 (160x); Height of marker strip: 3 mm; Strip length 182 mm; Horizontal marking; Self-adhesive	www.wago.com/210-332/500-204
	Item no.: 210-332/500-205 Marking strips; as a DIN A4 sheet; MARKED; 1-32 (80x); Height of marker strip: 3 mm; Strip length 182 mm; Horizontal marking; Self-adhesive	www.wago.com/210-332/500-205
	Item no.: 210-332/500-206 Marking strips; as a DIN A4 sheet; MARKED; 33-48 (160x); Height of marker strip: 3 mm; Strip length 182 mm; Horizontal marking; Self-adhesive	www.wago.com/210-332/500-206
	Item no.: 210-833 Marking strips; on reel; 6 mm wide; plain; Self-adhesive	www.wago.com/210-833

tools

	Item no.: 210-647 Operating tool with partially insulated shaft; Blade (2.5 x 0.4) mm; short	www.wago.com/210-647
	Item no.: 210-648 Operating tool with partially insulated shaft; Blade (2.5 x 0.4) mm; short; angled	www.wago.com/210-648
	Item no.: 210-719 Operating tool with partially insulated shaft; Type 1, blade (2.5 x 0.4) mm	www.wago.com/210-719

Downloads

smartDATA

CAD data

3D Download 253-103	URL	Download
---------------------	-----	----------

PCB libraries

TARGET Library for WAGO PCB Terminal Blocks Compatible with TARGET PCB Design Software Version 17.x	1.1.0 Oct 6, 2014	ZIP 27.1 MB	Download
EAGLE Library for WAGO PCB Terminal Blocks Compatible with EAGLE PCB Design Software Version 6.x or higher	2.1 Nov 17, 2017	ZIP 23.9 MB	Download
DesignSpark Library for WAGO PCB Terminal Blocks Compatible with DesignSpark PCB Version 4.x or higher	2.1 Oct 6, 2014	ZIP 22.5 MB	Download

Subject to changes.

WAGO Kontakttechnik GmbH & Co. KG
Hansastr. 27
32423 Minden
Phone: +49571 887-0 | Fax: +49571 887-169
Email: info.de@wago.com | Web: www.wago.com

Do you have any questions about our products?
We are always happy to take your call at +49 (571) 887-44222.