

Data sheet | Item number: 261-430/341-000

2-conductor terminal strip; with fixing flange; for screw or similar mounting types; Fixing hole 3.2 mm Ø; with 209-123 mounting carrier for DIN 35 rail; with push-button

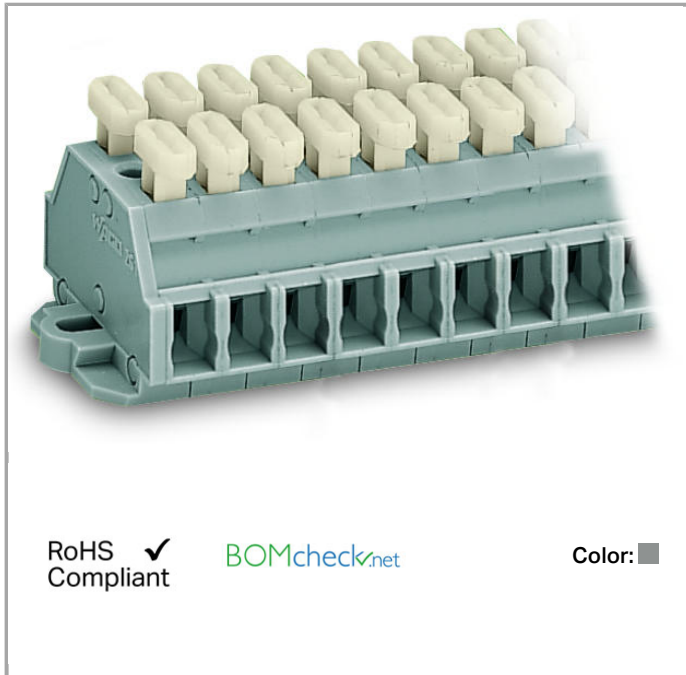

www.wago.com/261-430/341-000



RoHS
Compliant ✓

BOMcheck.net

Color: ■

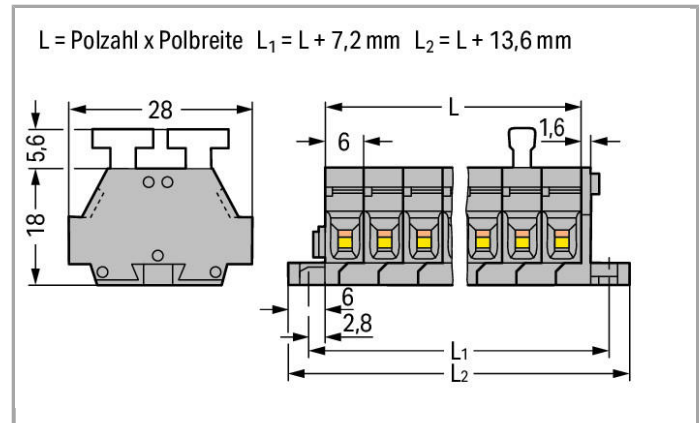

Data

Electrical data

Ratings per IEC/EN 60664-1

Rated voltage (III / 3)	500 V
Rated impulse voltage (III / 3)	6 kV
Rated current	24 A
Legend (ratings)	(III / 3) ≙ Overvoltage category III / Pollution degree 3

Connection data

Connection technology	CAGE CLAMP®
Actuation type	Operating tool Push-button
Connectable conductor materials	Copper Aluminum
Solid conductor	0.08 ... 2.5 mm ² / 28 ... 14 AWG
Fine-stranded conductor	0.08 ... 2.5 mm ² / 28 ... 14 AWG
Strip length	8 ... 9 mm / 0.31 ... 0.35 Inch
No. of poles	10
Total number of connection points	20

Total number of potentials	10
Number of levels	1
Type of wiring	Side-entry wiring

Geometrical Data

Width	73.6 mm / 2.898 inch
Height from the surface	23.2 mm / 0.913 inch
Depth	28 mm / 1.102 inch

Mechanical data

Design	horizontal
Mounting type	Mounting flange
Marking level	Side marking

Material Data

Color	gray
Fire load	0.57 MJ
Weight	28.191 g

Commercial data

Country of origin	DE
GTIN	4044918627498
Customs Tariff No.	85369010000

Compatible products

assembling



Item no.: 209-137

Mounting adapter; can be used as end plate; 6.5 mm wide

www.wago.com/209-137

ferrule



Item no.: 216-101

Ferrule; Sleeve for 0.5 mm² / AWG 22; uninsulated; electro-tin plated

www.wago.com/216-101



Item no.: 216-102

Ferrule; Sleeve for 0.75 mm² / AWG 20; uninsulated; electro-tin plated

www.wago.com/216-102



Item no.: 216-103

Ferrule; Sleeve for 1 mm² / AWG 18; uninsulated; electro-tin plated

www.wago.com/216-103



Item no.: 216-104

Ferrule; Sleeve for 1.5 mm² / AWG 16; uninsulated; electro-tin plated





















www.wago.com/216-104



Item no.: 216-106

Ferrule; Sleeve for 2.5 mm² / AWG 14; uninsulated; electro-tin plated

www.wago.com/216-106

	Item no.: 216-121 Ferrule; Sleeve for 0.5 mm ² / AWG 22; uninsulated; electro-tin plated	www.wago.com/216-121
	Item no.: 216-122 Ferrule; Sleeve for 0.75 mm ² / AWG 20; uninsulated; electro-tin plated	www.wago.com/216-122
	Item no.: 216-123 Ferrule; Sleeve for 1 mm ² / AWG 18; uninsulated; electro-tin plated	www.wago.com/216-123
	Item no.: 216-124 Ferrule; Sleeve for 1.5 mm ² / AWG 16; uninsulated; electro-tin plated	www.wago.com/216-124
	Item no.: 216-131 Ferrule; Sleeve for 0.25 mm ² / AWG 24; uninsulated; electro-tin plated	www.wago.com/216-131
	Item no.: 216-132 Ferrule; Sleeve for 0.34 mm ² / AWG 24; uninsulated; electro-tin plated	www.wago.com/216-132
	Item no.: 216-151 Ferrule; Sleeve for 0.25 mm ² / AWG 24; uninsulated; electro-tin plated	www.wago.com/216-151
	Item no.: 216-152 Ferrule; Sleeve for 0.34 mm ² / AWG 24; uninsulated; electro-tin plated	www.wago.com/216-152
	Item no.: 216-201 Ferrule; Sleeve for 0.5 mm ² / AWG 22; insulated; electro-tin plated	www.wago.com/216-201
	Item no.: 216-202 Ferrule; Sleeve for 0.75 mm ² / AWG 20; insulated; electro-tin plated	www.wago.com/216-202
	Item no.: 216-203 Ferrule; Sleeve for 1 mm ² / AWG 18; insulated; electro-tin plated	www.wago.com/216-203
	Item no.: 216-204 Ferrule; Sleeve for 1.5 mm ² / AWG 16; insulated; electro-tin plated	www.wago.com/216-204
	Item no.: 216-205 Ferrule; Sleeve for 2.08 mm ² / AWG 14; insulated; electro-tin plated	www.wago.com/216-205
	Item no.: 216-206 Ferrule; Sleeve for 2.5 mm ² / AWG 14; insulated; electro-tin plated	www.wago.com/216-206
	Item no.: 216-221 Ferrule; Sleeve for 0.5 mm ² / AWG 22; insulated; electro-tin plated	www.wago.com/216-221
	Item no.: 216-222 Ferrule; Sleeve for 0.75 mm ² / AWG 20; insulated; electro-tin plated	www.wago.com/216-222
	Item no.: 216-223 Ferrule; Sleeve for 1 mm ² / AWG 18; insulated; electro-tin plated	www.wago.com/216-223
	Item no.: 216-224 Ferrule; Sleeve for 1.5 mm ² / AWG 16; insulated; electro-tin plated	www.wago.com/216-224
	Item no.: 216-301 Ferrule; Sleeve for 0.25 mm ² / AWG 24; insulated; electro-tin plated	www.wago.com/216-301
	Item no.: 216-302 Ferrule; Sleeve for 0.34 mm ² / AWG 24; insulated; electro-tin plated	www.wago.com/216-302



Item no.: 216-321
Ferrule; Sleeve for 0.25 mm² / AWG 24; insulated; electro-tin plated

www.wago.com/216-321



Item no.: 216-322
Ferrule; Sleeve for 0.34 mm² / AWG 24; insulated; electro-tin plated

www.wago.com/216-322

tools



Item no.: 209-132
Operating tool; for connecting comb-style jumper bar; 2-way; of insulating material

www.wago.com/209-132



Item no.: 210-657
Operating tool with partially insulated shaft; Blade (3.5 x 0.5) mm; short

www.wago.com/210-657



Item no.: 210-658
Operating tool with partially insulated shaft; Blade (3.5 x 0.5) mm; short; angled

www.wago.com/210-658



Item no.: 210-720
Operating tool with partially insulated shaft; Type 2, blade (3.5 x 0.5) mm

www.wago.com/210-720

check



Item no.: 210-136
Test plug; 2 mm Ø; with 500 mm cable

www.wago.com/210-136

Marking accessories



Item no.: 2009-145
Mini-WSB Inline; for smartPRINTER; on reel; stretchable 5 - 5.2 mm; plain; snap-on type

www.wago.com/2009-145



Item no.: 2009-145/000-002
Mini-WSB Inline; for smartPRINTER; on reel; stretchable 5 - 5.2 mm; plain; snap-on type

www.wago.com/2009-145/000-002



Item no.: 2009-145/000-005
Mini-WSB Inline; for smartPRINTER; on reel; stretchable 5 - 5.2 mm; plain; snap-on type

www.wago.com/2009-145/000-005



Item no.: 2009-145/000-006
Mini-WSB Inline; for smartPRINTER; on reel; stretchable 5 - 5.2 mm; plain; snap-on type

www.wago.com/2009-145/000-006



Item no.: 2009-145/000-007
Mini-WSB Inline; for smartPRINTER; on reel; stretchable 5 - 5.2 mm; plain; snap-on type

www.wago.com/2009-145/000-007



Item no.: 2009-145/000-012
Mini-WSB Inline; for smartPRINTER; on reel; stretchable 5 - 5.2 mm; plain; snap-on type

www.wago.com/2009-145/000-012



Item no.: 2009-145/000-023
Mini-WSB Inline; for smartPRINTER; on reel; stretchable 5 - 5.2 mm; plain; snap-on type

www.wago.com/2009-145/000-023



Item no.: 2009-145/000-024
Mini-WSB Inline; on reel; stretchable 5 - 5.2 mm; plain; snap-on type

www.wago.com/2009-145/000-024



Item no.: 248-501

Miniature WSB Quick marking system; plain; Marker width 5 mm; 10 strips with 10 markers per card

www.wago.com/248-501



Item no.: 248-501/000-002

Mini-WSB marking card; as card; not stretchable; plain; snap-on type

www.wago.com/248-501/000-002



Item no.: 248-501/000-005

Mini-WSB marking card; as card; plain; snap-on type

www.wago.com/248-501/000-005



Item no.: 248-501/000-006

Mini-WSB marking card; as card; not stretchable; plain; snap-on type

www.wago.com/248-501/000-006



Item no.: 248-501/000-007

Mini-WSB marking card; as card; not stretchable; plain; snap-on type

www.wago.com/248-501/000-007



Item no.: 248-501/000-012

Mini-WSB marking card; as card; not stretchable; plain; snap-on type

www.wago.com/248-501/000-012



Item no.: 248-501/000-017

Mini-WSB marking card; as card; not stretchable; plain; snap-on type

www.wago.com/248-501/000-017



Item no.: 248-501/000-023

Mini-WSB marking card; as card; not stretchable; plain; snap-on type

www.wago.com/248-501/000-023



Item no.: 248-501/000-024

Mini-WSB marking card; as card; not stretchable; plain; snap-on type

www.wago.com/248-501/000-024

General accessories



Item no.: 209-123

Mounting foot with screw; can be screwed on terminal blocks with fixing flange; 6.4 mm wide

www.wago.com/209-123

Jumper



Item no.: 261-402

Comb-style jumper bar; insulated; 2-way; reduces conductor size to 1.5 mm

www.wago.com/261-402

Downloads

Documentation

Bid Text

261-430/341-000

Oct 11, 2017

DOC
25.6 kB

Download



smartDATA

CAD data

3D Download 261-430/341-000

URL

Download

Subject to changes.

WAGO Kontakttechnik GmbH & Co. KG

Hansastr. 27

32423 Minden

Phone: +49571 887-0 | Fax: +49571 887-169

Email: info.de@wago.com | Web: www.wago.com

Do you have any questions about our products?

We are always happy to take your call at +49 (571) 887-44222.