

## Data sheet | Item number: 264-161

2-conductor terminal strip; with snap-in mounting feet; for plate thickness 0.6 - 1.2 mm; Fixing hole 3.5 mm Ø; also fits 210-154 aluminum rail or with 209-123 mounting carrier for DIN 35 rail; 11-pole

[www.wago.com/264-161](http://www.wago.com/264-161)

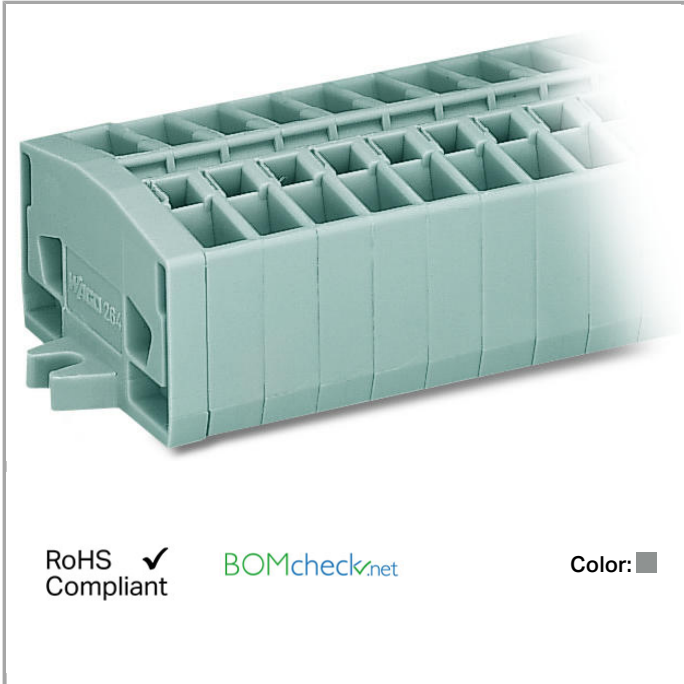

RoHS  Compliant

BOMcheck.net

Color: ■

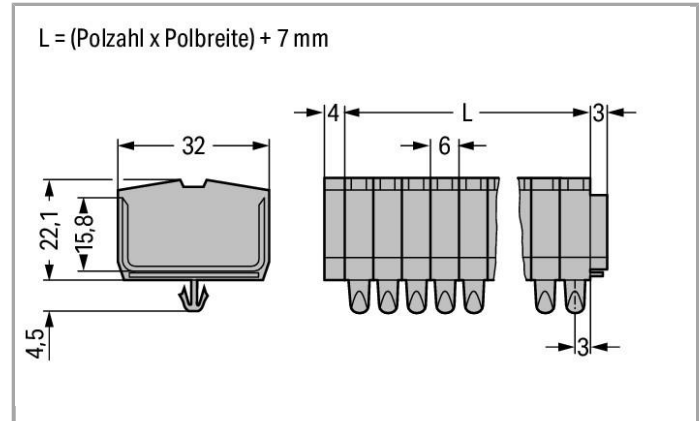

### Data

#### Electrical data

#### Ratings per IEC/EN 60664-1

Rated voltage (III / 3)	800 V
Rated impulse voltage (III / 3)	8 kV
Rated current	24 A
Legend (ratings)	(III / 3) ≙ Overvoltage category III / Pollution degree 3

#### Connection data

Connection technology	CAGE CLAMP®
Actuation type	Operating tool
Connectable conductor materials	Copper Aluminum
Solid conductor	0.08 ... 2.5 mm <sup>2</sup> / 28 ... 12 AWG
Fine-stranded conductor	0.08 ... 2.5 mm <sup>2</sup> / 28 ... 12 AWG
Strip length	8 ... 9 mm / 0.31 ... 0.35 Inch
No. of poles	11
Total number of connection points	22

Total number of potentials	11
Number of levels	1
Type of wiring	Front-entry wiring

### Geometrical Data

Width	73 mm / 2.874 inch
Height from the surface	22.1 mm / 0.87 inch
Depth	32 mm / 1.26 inch

### Mechanical data

Design	horizontal
Mounting type	Snap-in mounting foot
Marking level	Center marking

### Material Data



Color	gray
Fire load	0.885 MJ
Weight	44.394 g

### Commercial data

Country of origin	DE
GTIN	4044918423700
Customs Tariff No.	85369010000
Product Group	9 (Std. Chassis Mt. Blocks)

### Approvals / Certificates

#### Country specific Approvals



Logo	Approval	Certificate name
	CB DEKRA Certification B.V.	NL-49768
	CCA DEKRA Certification B.V.	NTR NL-7342
	CCA DEKRA Certification B.V.	NTR NL-7342
	CCA DEKRA Certification B.V.	2175624.01



CSA  
DEKRA Certification B.V.

70010891

## Ship Approvals





Logo	Approval	Certificate name
	<b>ABS</b> American Bureau of Shipping	14-HG1241539-PDA
	<b>DNV GL</b> Det Norske Veritas, Germanischer Lloyd	TAE00001V2
	<b>LR</b> Lloyds Register	91/20242 (E7)





















## UL-Approvals

















Logo	Approval	Certificate name
	<b>UR</b> Underwriters Laboratories Inc.	E45172, sec. 6















## Compatible products

## General accessories

	<b>Item no.: 209-122</b> Plastic end stop; for WSB markers; for 210-154 aluminum rail	<a href="http://www.wago.com/209-122">www.wago.com/209-122</a>
<b>Jumper</b>		
	<b>Item no.: 264-402</b> Comb-style jumper bar; insulated; 2-way; reduces conductor size to 1.5 mm	<a href="http://www.wago.com/264-402">www.wago.com/264-402</a>
	<b>Item no.: 281-492</b> Alternate comb-style jumper bar; insulated; 2-way; IN = IN terminal block	<a href="http://www.wago.com/281-492">www.wago.com/281-492</a>
<b>Carrier rail</b>		
	<b>Item no.: 210-154</b> Aluminum carrier rail; 1000 mm long; 18 mm wide; 7 mm high	<a href="http://www.wago.com/210-154">www.wago.com/210-154</a>
<b>ferrule</b>		
	<b>Item no.: 216-101</b> Ferrule; Sleeve for 0.5 mm <sup>2</sup> / AWG 22; uninsulated; electro-tin plated	<a href="http://www.wago.com/216-101">www.wago.com/216-101</a>

	<b>Item no.: 216-102</b> Ferrule; Sleeve for 0.75 mm <sup>2</sup> / AWG 20; uninsulated; electro-tin plated	<a href="http://www.wago.com/216-102">www.wago.com/216-102</a>
	<b>Item no.: 216-103</b> Ferrule; Sleeve for 1 mm <sup>2</sup> / AWG 18; uninsulated; electro-tin plated	<a href="http://www.wago.com/216-103">www.wago.com/216-103</a>
	<b>Item no.: 216-104</b> Ferrule; Sleeve for 1.5 mm <sup>2</sup> / AWG 16; uninsulated; electro-tin plated	<a href="http://www.wago.com/216-104">www.wago.com/216-104</a>
	<b>Item no.: 216-106</b> Ferrule; Sleeve for 2.5 mm <sup>2</sup> / AWG 14; uninsulated; electro-tin plated	<a href="http://www.wago.com/216-106">www.wago.com/216-106</a>
	<b>Item no.: 216-121</b> Ferrule; Sleeve for 0.5 mm <sup>2</sup> / AWG 22; uninsulated; electro-tin plated	<a href="http://www.wago.com/216-121">www.wago.com/216-121</a>
	<b>Item no.: 216-122</b> Ferrule; Sleeve for 0.75 mm <sup>2</sup> / AWG 20; uninsulated; electro-tin plated	<a href="http://www.wago.com/216-122">www.wago.com/216-122</a>
	<b>Item no.: 216-123</b> Ferrule; Sleeve for 1 mm <sup>2</sup> / AWG 18; uninsulated; electro-tin plated	<a href="http://www.wago.com/216-123">www.wago.com/216-123</a>
	<b>Item no.: 216-124</b> Ferrule; Sleeve for 1.5 mm <sup>2</sup> / AWG 16; uninsulated; electro-tin plated	<a href="http://www.wago.com/216-124">www.wago.com/216-124</a>
	<b>Item no.: 216-131</b> Ferrule; Sleeve for 0.25 mm <sup>2</sup> / AWG 24; uninsulated; electro-tin plated	<a href="http://www.wago.com/216-131">www.wago.com/216-131</a>
	<b>Item no.: 216-132</b> Ferrule; Sleeve for 0.34 mm <sup>2</sup> / AWG 24; uninsulated; electro-tin plated	<a href="http://www.wago.com/216-132">www.wago.com/216-132</a>
	<b>Item no.: 216-151</b> Ferrule; Sleeve for 0.25 mm <sup>2</sup> / AWG 24; uninsulated; electro-tin plated	<a href="http://www.wago.com/216-151">www.wago.com/216-151</a>
	<b>Item no.: 216-152</b> Ferrule; Sleeve for 0.34 mm <sup>2</sup> / AWG 24; uninsulated; electro-tin plated	<a href="http://www.wago.com/216-152">www.wago.com/216-152</a>
	<b>Item no.: 216-201</b> Ferrule; Sleeve for 0.5 mm <sup>2</sup> / AWG 22; insulated; electro-tin plated	<a href="http://www.wago.com/216-201">www.wago.com/216-201</a>
	<b>Item no.: 216-202</b> Ferrule; Sleeve for 0.75 mm <sup>2</sup> / AWG 20; insulated; electro-tin plated	<a href="http://www.wago.com/216-202">www.wago.com/216-202</a>
	<b>Item no.: 216-203</b> Ferrule; Sleeve for 1 mm <sup>2</sup> / AWG 18; insulated; electro-tin plated	<a href="http://www.wago.com/216-203">www.wago.com/216-203</a>
	<b>Item no.: 216-204</b> Ferrule; Sleeve for 1.5 mm <sup>2</sup> / AWG 16; insulated; electro-tin plated	<a href="http://www.wago.com/216-204">www.wago.com/216-204</a>
	<b>Item no.: 216-205</b> Ferrule; Sleeve for 2.08 mm <sup>2</sup> / AWG 14; insulated; electro-tin plated	<a href="http://www.wago.com/216-205">www.wago.com/216-205</a>
	<b>Item no.: 216-206</b> Ferrule; Sleeve for 2.5 mm <sup>2</sup> / AWG 14; insulated; electro-tin plated	<a href="http://www.wago.com/216-206">www.wago.com/216-206</a>
	<b>Item no.: 216-221</b> Ferrule; Sleeve for 0.5 mm <sup>2</sup> / AWG 22; insulated; electro-tin plated	<a href="http://www.wago.com/216-221">www.wago.com/216-221</a>
	<b>Item no.: 216-222</b> Ferrule; Sleeve for 0.75 mm <sup>2</sup> / AWG 20; insulated; electro-tin plated	<a href="http://www.wago.com/216-222">www.wago.com/216-222</a>

	<b>Item no.: 216-223</b> Ferrule; Sleeve for 1 mm <sup>2</sup> / AWG 18; insulated; electro-tin plated	<a href="http://www.wago.com/216-223">www.wago.com/216-223</a>
	<b>Item no.: 216-224</b> Ferrule; Sleeve for 1.5 mm <sup>2</sup> / AWG 16; insulated; electro-tin plated	<a href="http://www.wago.com/216-224">www.wago.com/216-224</a>
	<b>Item no.: 216-321</b> Ferrule; Sleeve for 0.25 mm <sup>2</sup> / AWG 24; insulated; electro-tin plated	<a href="http://www.wago.com/216-321">www.wago.com/216-321</a>
	<b>Item no.: 216-322</b> Ferrule; Sleeve for 0.34 mm <sup>2</sup> / AWG 24; insulated; electro-tin plated	<a href="http://www.wago.com/216-322">www.wago.com/216-322</a>
<b>assembling</b>		
	<b>Item no.: 709-153</b> Cover; Type 1; suitable for cover carrier, type 1; 1 m long	<a href="http://www.wago.com/709-153">www.wago.com/709-153</a>
<b>tools</b>		
	<b>Item no.: 209-130</b> Operating tool; suitable for 264, 280 and 281 Series; 1-way; of insulating material	<a href="http://www.wago.com/209-130">www.wago.com/209-130</a>
	<b>Item no.: 210-657</b> Operating tool with partially insulated shaft; Blade (3.5 x 0.5) mm; short	<a href="http://www.wago.com/210-657">www.wago.com/210-657</a>
	<b>Item no.: 210-658</b> Operating tool with partially insulated shaft; Blade (3.5 x 0.5) mm; short; angled	<a href="http://www.wago.com/210-658">www.wago.com/210-658</a>
	<b>Item no.: 210-720</b> Operating tool with partially insulated shaft; Type 2, blade (3.5 x 0.5) mm	<a href="http://www.wago.com/210-720">www.wago.com/210-720</a>
	<b>Item no.: 280-432</b> Operating tool; of insulating material; 2-way	<a href="http://www.wago.com/280-432">www.wago.com/280-432</a>
<b>Marking accessories</b>		
	<b>Item no.: 2009-145</b> Mini-WSB Inline; for smartPRINTER; on reel; stretchable 5 - 5.2 mm; plain; snap-on type	<a href="http://www.wago.com/2009-145">www.wago.com/2009-145</a>
	<b>Item no.: 2009-145/000-002</b> Mini-WSB Inline; for smartPRINTER; on reel; stretchable 5 - 5.2 mm; plain; snap-on type	<a href="http://www.wago.com/2009-145/000-002">www.wago.com/2009-145/000-002</a>
	<b>Item no.: 2009-145/000-005</b> Mini-WSB Inline; for smartPRINTER; on reel; stretchable 5 - 5.2 mm; plain; snap-on type	<a href="http://www.wago.com/2009-145/000-005">www.wago.com/2009-145/000-005</a>
	<b>Item no.: 2009-145/000-006</b> Mini-WSB Inline; for smartPRINTER; on reel; stretchable 5 - 5.2 mm; plain; snap-on type	<a href="http://www.wago.com/2009-145/000-006">www.wago.com/2009-145/000-006</a>
	<b>Item no.: 2009-145/000-007</b> Mini-WSB Inline; for smartPRINTER; on reel; stretchable 5 - 5.2 mm; plain; snap-on type	<a href="http://www.wago.com/2009-145/000-007">www.wago.com/2009-145/000-007</a>
	<b>Item no.: 2009-145/000-012</b> Mini-WSB Inline; for smartPRINTER; on reel; stretchable 5 - 5.2 mm; plain; snap-on type	<a href="http://www.wago.com/2009-145/000-012">www.wago.com/2009-145/000-012</a>

	<b>Item no.:</b> 2009-145/000-023 Mini-WSB Inline; for smartPRINTER; on reel; stretchable 5 - 5.2 mm; plain; snap-on type	<a href="http://www.wago.com/2009-145/000-023">www.wago.com/2009-145/000-023</a>
	<b>Item no.:</b> 2009-145/000-024 Mini-WSB Inline; on reel; stretchable 5 - 5.2 mm; plain; snap-on type	<a href="http://www.wago.com/2009-145/000-024">www.wago.com/2009-145/000-024</a>
	<b>Item no.:</b> 209-290 Marker tags; not stretchable; plain; snap-on type	<a href="http://www.wago.com/209-290">www.wago.com/209-290</a>
	<b>Item no.:</b> 248-501 Miniature WSB Quick marking system; plain; Marker width 5 mm; 10 strips with 10 markers per card	<a href="http://www.wago.com/248-501">www.wago.com/248-501</a>
	<b>Item no.:</b> 248-501/000-002 Mini-WSB marking card; as card; not stretchable; plain; snap-on type	<a href="http://www.wago.com/248-501/000-002">www.wago.com/248-501/000-002</a>
	<b>Item no.:</b> 248-501/000-005 Mini-WSB marking card; as card; plain; snap-on type	<a href="http://www.wago.com/248-501/000-005">www.wago.com/248-501/000-005</a>
	<b>Item no.:</b> 248-501/000-006 Mini-WSB marking card; as card; not stretchable; plain; snap-on type	<a href="http://www.wago.com/248-501/000-006">www.wago.com/248-501/000-006</a>
	<b>Item no.:</b> 248-501/000-007 Mini-WSB marking card; as card; not stretchable; plain; snap-on type	<a href="http://www.wago.com/248-501/000-007">www.wago.com/248-501/000-007</a>
	<b>Item no.:</b> 248-501/000-012 Mini-WSB marking card; as card; not stretchable; plain; snap-on type	<a href="http://www.wago.com/248-501/000-012">www.wago.com/248-501/000-012</a>
	<b>Item no.:</b> 248-501/000-017 Mini-WSB marking card; as card; not stretchable; plain; snap-on type	<a href="http://www.wago.com/248-501/000-017">www.wago.com/248-501/000-017</a>
	<b>Item no.:</b> 248-501/000-023 Mini-WSB marking card; as card; not stretchable; plain; snap-on type	<a href="http://www.wago.com/248-501/000-023">www.wago.com/248-501/000-023</a>
	<b>Item no.:</b> 248-501/000-024 Mini-WSB marking card; as card; not stretchable; plain; snap-on type	<a href="http://www.wago.com/248-501/000-024">www.wago.com/248-501/000-024</a>
<b>check</b>		
	<b>Item no.:</b> 210-136 Test plug; 2 mm Ø; with 500 mm cable	<a href="http://www.wago.com/210-136">www.wago.com/210-136</a>
	<b>Item no.:</b> 210-137 Test plug; 2.3 mm Ø; with 500 mm cable	<a href="http://www.wago.com/210-137">www.wago.com/210-137</a>
	<b>Item no.:</b> 249-136 Test plug module; without locking device; modular; for 2-conductor terminal blocks	<a href="http://www.wago.com/249-136">www.wago.com/249-136</a>



Downloads

Documentation

Bid Text

---

264-161	Oct 11, 2017	DOC 25.6 kB	Download
---------	--------------	----------------	----------

---

smartDATA

CAD data

---

3D Download 264-161	URL	Download
---------------------	-----	----------

---

Subject to changes.