

## Data sheet | Item number: 264-189

2-conductor Ex e II terminal strip; with snap-in mounting feet; for plate thickness 0.6 - 1.2 mm; Fixing hole 3.5 mm Ø; also fits 210-154 aluminum rail or with 209-123 mounting carrier for DIN 35 rail; suitable for Ex e II applications; 9-pole

[www.wago.com/264-189](http://www.wago.com/264-189)



RoHS  
Compliant

BOMcheck.net

Color: ■

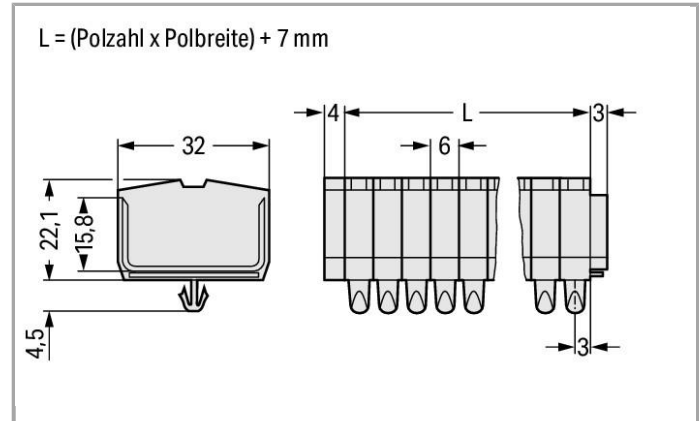

### Data

#### Electrical data

Rated voltage EN (Ex e II) 690 V

#### Ratings per IEC/EN 60664-1

Rated current 23 A

#### Connection data

Connection technology	CAGE CLAMP®
Actuation type	Operating tool
Connectable conductor materials	Copper Aluminum
Solid conductor	0.08 ... 2.5 mm <sup>2</sup> / 28 ... 12 AWG
Fine-stranded conductor	0.08 ... 2.5 mm <sup>2</sup> / 28 ... 12 AWG
Strip length	8 ... 9 mm / 0.31 ... 0.35 Inch
No. of poles	9
Total number of connection points	18
Total number of potentials	9

Number of levels	1
Type of wiring	Front-entry wiring

### Geometrical Data

Width	61 mm / 2.402 inch
Height from the surface	22.1 mm / 0.87 inch
Depth	32 mm / 1.26 inch

### Mechanical data

Design	horizontal
Marking level	Center marking

### Material Data



Color	light gray
Fire load	0.722 MJ
Weight	37.771 g

### Commercial data

Country of origin	DE
GTIN	4044918423328
Customs Tariff No.	85369010000
Product Group	9 (Std. Chassis Mt. Blocks)

### Approvals / Certificates

#### Ex-Approvals

Logo	Approval	Certificate name
	AEx UL International Germany GmbH c/o Physikalisch Technische Bundesanstalt	E185892
	ATEX Physikalisch Technische Bundesanstalt (PTB)	PTB 98 ATEX 3129 U (II 2 G/D EEx e II)
	IECEX Physikalisch Technische Bundesanstalt (PTB)	IECEX PTB 04.0003U (Ex e IIC Gb)

#### Country specific Approvals

Logo	Approval	Certificate name
	CSA DEKRA Certification B.V.	70010891











## Ship Approvals



















Logo	Approval	Certificate name
	LR Lloyds Register	91/20242 (E7)

## UL-Approvals

Logo	Approval	Certificate name
	UR Underwriters Laboratories Inc.	E45172, sec. 6

## Compatible products

Jumper		
	<b>Item no.: 264-402</b> Comb-style jumper bar; insulated; 2-way; reduces conductor size to 1.5 mm	<a href="http://www.wago.com/264-402">www.wago.com/264-402</a>
	<b>Item no.: 281-492</b> Alternate comb-style jumper bar; insulated; 2-way; IN = IN terminal block	<a href="http://www.wago.com/281-492">www.wago.com/281-492</a>
check		
	<b>Item no.: 249-136</b> Test plug module; without locking device; modular; for 2-conductor terminal blocks	<a href="http://www.wago.com/249-136">www.wago.com/249-136</a>
ferrule		
	<b>Item no.: 216-101</b> Ferrule; Sleeve for 0.5 mm <sup>2</sup> / AWG 22; uninsulated; electro-tin plated	<a href="http://www.wago.com/216-101">www.wago.com/216-101</a>
	<b>Item no.: 216-102</b> Ferrule; Sleeve for 0.75 mm <sup>2</sup> / AWG 20; uninsulated; electro-tin plated	<a href="http://www.wago.com/216-102">www.wago.com/216-102</a>
	<b>Item no.: 216-103</b> Ferrule; Sleeve for 1 mm <sup>2</sup> / AWG 18; uninsulated; electro-tin plated	<a href="http://www.wago.com/216-103">www.wago.com/216-103</a>
	<b>Item no.: 216-104</b> Ferrule; Sleeve for 1.5 mm <sup>2</sup> / AWG 16; uninsulated; electro-tin plated	<a href="http://www.wago.com/216-104">www.wago.com/216-104</a>
	<b>Item no.: 216-106</b> Ferrule; Sleeve for 2.5 mm <sup>2</sup> / AWG 14; uninsulated; electro-tin plated	<a href="http://www.wago.com/216-106">www.wago.com/216-106</a>
	<b>Item no.: 216-121</b> Ferrule; Sleeve for 0.5 mm <sup>2</sup> / AWG 22; uninsulated; electro-tin plated	<a href="http://www.wago.com/216-121">www.wago.com/216-121</a>

	<b>Item no.: 216-122</b> Ferrule; Sleeve for 0.75 mm <sup>2</sup> / AWG 20; uninsulated; electro-tin plated	<a href="http://www.wago.com/216-122">www.wago.com/216-122</a>
	<b>Item no.: 216-123</b> Ferrule; Sleeve for 1 mm <sup>2</sup> / AWG 18; uninsulated; electro-tin plated	<a href="http://www.wago.com/216-123">www.wago.com/216-123</a>
	<b>Item no.: 216-124</b> Ferrule; Sleeve for 1.5 mm <sup>2</sup> / AWG 16; uninsulated; electro-tin plated	<a href="http://www.wago.com/216-124">www.wago.com/216-124</a>
	<b>Item no.: 216-131</b> Ferrule; Sleeve for 0.25 mm <sup>2</sup> / AWG 24; uninsulated; electro-tin plated	<a href="http://www.wago.com/216-131">www.wago.com/216-131</a>
	<b>Item no.: 216-132</b> Ferrule; Sleeve for 0.34 mm <sup>2</sup> / AWG 24; uninsulated; electro-tin plated	<a href="http://www.wago.com/216-132">www.wago.com/216-132</a>
	<b>Item no.: 216-151</b> Ferrule; Sleeve for 0.25 mm <sup>2</sup> / AWG 24; uninsulated; electro-tin plated	<a href="http://www.wago.com/216-151">www.wago.com/216-151</a>
	<b>Item no.: 216-152</b> Ferrule; Sleeve for 0.34 mm <sup>2</sup> / AWG 24; uninsulated; electro-tin plated	<a href="http://www.wago.com/216-152">www.wago.com/216-152</a>
	<b>Item no.: 216-201</b> Ferrule; Sleeve for 0.5 mm <sup>2</sup> / AWG 22; insulated; electro-tin plated	<a href="http://www.wago.com/216-201">www.wago.com/216-201</a>
	<b>Item no.: 216-202</b> Ferrule; Sleeve for 0.75 mm <sup>2</sup> / AWG 20; insulated; electro-tin plated	<a href="http://www.wago.com/216-202">www.wago.com/216-202</a>
	<b>Item no.: 216-203</b> Ferrule; Sleeve for 1 mm <sup>2</sup> / AWG 18; insulated; electro-tin plated	<a href="http://www.wago.com/216-203">www.wago.com/216-203</a>
	<b>Item no.: 216-204</b> Ferrule; Sleeve for 1.5 mm <sup>2</sup> / AWG 16; insulated; electro-tin plated	<a href="http://www.wago.com/216-204">www.wago.com/216-204</a>
	<b>Item no.: 216-205</b> Ferrule; Sleeve for 2.08 mm <sup>2</sup> / AWG 14; insulated; electro-tin plated	<a href="http://www.wago.com/216-205">www.wago.com/216-205</a>
	<b>Item no.: 216-206</b> Ferrule; Sleeve for 2.5 mm <sup>2</sup> / AWG 14; insulated; electro-tin plated	<a href="http://www.wago.com/216-206">www.wago.com/216-206</a>
	<b>Item no.: 216-221</b> Ferrule; Sleeve for 0.5 mm <sup>2</sup> / AWG 22; insulated; electro-tin plated	<a href="http://www.wago.com/216-221">www.wago.com/216-221</a>
	<b>Item no.: 216-222</b> Ferrule; Sleeve for 0.75 mm <sup>2</sup> / AWG 20; insulated; electro-tin plated	<a href="http://www.wago.com/216-222">www.wago.com/216-222</a>
	<b>Item no.: 216-223</b> Ferrule; Sleeve for 1 mm <sup>2</sup> / AWG 18; insulated; electro-tin plated	<a href="http://www.wago.com/216-223">www.wago.com/216-223</a>
	<b>Item no.: 216-224</b> Ferrule; Sleeve for 1.5 mm <sup>2</sup> / AWG 16; insulated; electro-tin plated	<a href="http://www.wago.com/216-224">www.wago.com/216-224</a>
	<b>Item no.: 216-321</b> Ferrule; Sleeve for 0.25 mm <sup>2</sup> / AWG 24; insulated; electro-tin plated	<a href="http://www.wago.com/216-321">www.wago.com/216-321</a>
	<b>Item no.: 216-322</b> Ferrule; Sleeve for 0.34 mm <sup>2</sup> / AWG 24; insulated; electro-tin plated	<a href="http://www.wago.com/216-322">www.wago.com/216-322</a>

#### Carrier rail

---



**Item no.: 210-154**  
Aluminum carrier rail; 1000 mm long; 18 mm wide; 7 mm high

[www.wago.com/210-154](http://www.wago.com/210-154)

General accessories



**Item no.: 209-122**  
Plastic end stop; for WSB markers; for 210-154 aluminum rail

[www.wago.com/209-122](http://www.wago.com/209-122)

assembling



**Item no.: 709-153**  
Cover; Type 1; suitable for cover carrier, type 1; 1 m long

[www.wago.com/709-153](http://www.wago.com/709-153)

Marking accessories



**Item no.: 2009-145**  
Mini-WSB Inline; for smartPRINTER; on reel; stretchable 5 - 5.2 mm; plain; snap-on type

[www.wago.com/2009-145](http://www.wago.com/2009-145)



**Item no.: 2009-145/000-002**  
Mini-WSB Inline; for smartPRINTER; on reel; stretchable 5 - 5.2 mm; plain; snap-on type

[www.wago.com/2009-145/000-002](http://www.wago.com/2009-145/000-002)



**Item no.: 2009-145/000-005**  
Mini-WSB Inline; for smartPRINTER; on reel; stretchable 5 - 5.2 mm; plain; snap-on type

[www.wago.com/2009-145/000-005](http://www.wago.com/2009-145/000-005)



**Item no.: 2009-145/000-006**  
Mini-WSB Inline; for smartPRINTER; on reel; stretchable 5 - 5.2 mm; plain; snap-on type

[www.wago.com/2009-145/000-006](http://www.wago.com/2009-145/000-006)



**Item no.: 2009-145/000-007**  
Mini-WSB Inline; for smartPRINTER; on reel; stretchable 5 - 5.2 mm; plain; snap-on type

[www.wago.com/2009-145/000-007](http://www.wago.com/2009-145/000-007)



**Item no.: 2009-145/000-012**  
Mini-WSB Inline; for smartPRINTER; on reel; stretchable 5 - 5.2 mm; plain; snap-on type

[www.wago.com/2009-145/000-012](http://www.wago.com/2009-145/000-012)



**Item no.: 2009-145/000-023**  
Mini-WSB Inline; for smartPRINTER; on reel; stretchable 5 - 5.2 mm; plain; snap-on type

[www.wago.com/2009-145/000-023](http://www.wago.com/2009-145/000-023)



**Item no.: 2009-145/000-024**  
Mini-WSB Inline; on reel; stretchable 5 - 5.2 mm; plain; snap-on type

[www.wago.com/2009-145/000-024](http://www.wago.com/2009-145/000-024)



**Item no.: 209-290**  
Marker tags; not stretchable; plain; snap-on type

[www.wago.com/209-290](http://www.wago.com/209-290)



**Item no.: 248-501**  
Miniature WSB Quick marking system; plain; Marker width 5 mm; 10 strips with 10 markers per card

[www.wago.com/248-501](http://www.wago.com/248-501)



**Item no.: 248-501/000-002**  
Mini-WSB marking card; as card; not stretchable; plain; snap-on type

[www.wago.com/248-501/000-002](http://www.wago.com/248-501/000-002)



**Item no.: 248-501/000-005**  
Mini-WSB marking card; as card; plain; snap-on type

[www.wago.com/248-501/000-005](http://www.wago.com/248-501/000-005)



**Item no.: 248-501/000-006**  
Mini-WSB marking card; as card; not stretchable; plain; snap-on type

[www.wago.com/248-501/000-006](http://www.wago.com/248-501/000-006)



**Item no.: 248-501/000-007**  
Mini-WSB marking card; as card; not stretchable; plain; snap-on type

[www.wago.com/248-501/000-007](http://www.wago.com/248-501/000-007)



**Item no.: 248-501/000-012**  
Mini-WSB marking card; as card; not stretchable; plain; snap-on type

[www.wago.com/248-501/000-012](http://www.wago.com/248-501/000-012)



**Item no.: 248-501/000-017**  
Mini-WSB marking card; as card; not stretchable; plain; snap-on type

[www.wago.com/248-501/000-017](http://www.wago.com/248-501/000-017)



**Item no.: 248-501/000-023**  
Mini-WSB marking card; as card; not stretchable; plain; snap-on type

[www.wago.com/248-501/000-023](http://www.wago.com/248-501/000-023)



**Item no.: 248-501/000-024**  
Mini-WSB marking card; as card; not stretchable; plain; snap-on type

[www.wago.com/248-501/000-024](http://www.wago.com/248-501/000-024)

## tools



**Item no.: 209-130**  
Operating tool; suitable for 264, 280 and 281 Series; 1-way; of insulating material

[www.wago.com/209-130](http://www.wago.com/209-130)



**Item no.: 210-657**  
Operating tool with partially insulated shaft; Blade (3.5 x 0.5) mm; short

[www.wago.com/210-657](http://www.wago.com/210-657)



**Item no.: 210-658**  
Operating tool with partially insulated shaft; Blade (3.5 x 0.5) mm; short; angled

[www.wago.com/210-658](http://www.wago.com/210-658)



**Item no.: 210-720**  
Operating tool with partially insulated shaft; Type 2, blade (3.5 x 0.5) mm

[www.wago.com/210-720](http://www.wago.com/210-720)



**Item no.: 280-432**  
Operating tool; of insulating material; 2-way

[www.wago.com/280-432](http://www.wago.com/280-432)

## Downloads Documentation

### Bid Text

264-189

Oct 11, 2017

DOC  
25.6 kB

Download



**smartDATA**

**CAD data**

3D Download 264-189

URL

Download

---

Subject to changes.

---

WAGO Kontakttechnik GmbH & Co. KG

Hansastr. 27

32423 Minden

Phone: +49571 887-0 | Fax: +49571 887-169

Email: [info.de@wago.com](mailto:info.de@wago.com) | Web: [www.wago.com](http://www.wago.com)

Do you have any questions about our products?

We are always happy to take your call at +49 (571) 887-44222.