

Data sheet | Item number: 264-192

2-conductor Ex e II terminal strip; with snap-in mounting feet; for plate thickness 0.6 - 1.2 mm; Fixing hole 3.5 mm Ø; also fits 210-154 aluminum rail or with 209-123 mounting carrier for DIN 35 rail; suitable for Ex e II applications; 12-pole



www.wago.com/264-192



RoHS
Compliant

BOMcheck.net

Color: ■

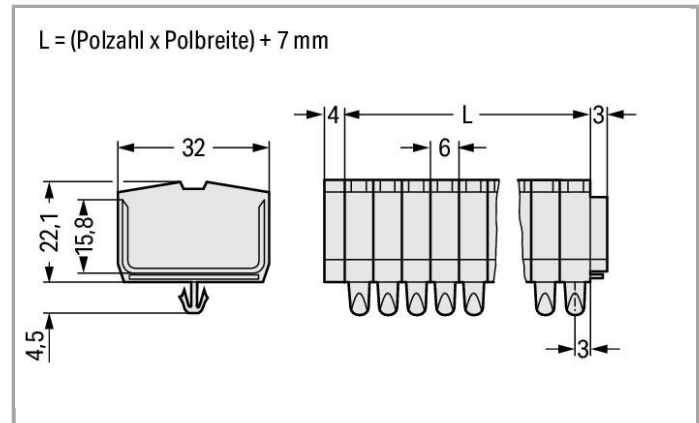

Data

Electrical data

Rated voltage EN (Ex e II) 690 V

Ratings per IEC/EN 60664-1

Rated current 23 A

Connection data

Connection technology	CAGE CLAMP®
Actuation type	Operating tool
Connectable conductor materials	Copper Aluminum
Solid conductor	0.08 ... 2.5 mm ² / 28 ... 12 AWG
Fine-stranded conductor	0.08 ... 2.5 mm ² / 28 ... 12 AWG
Strip length	8 ... 9 mm / 0.31 ... 0.35 Inch
No. of poles	12
Total number of connection points	24
Total number of potentials	12

Number of levels	1
Type of wiring	Front-entry wiring

Geometrical Data

Width	79 mm / 3.11 inch
Height from the surface	22.1 mm / 0.87 inch
Depth	32 mm / 1.26 inch

Mechanical data

Design	horizontal
Marking level	Center marking

Material Data



Color	light gray
Fire load	0.944 MJ
Weight	54.27 g

Commercial data

Country of origin	DE
GTIN	4044918423359
Customs Tariff No.	85369010000
Product Group	9 (Std. Chassis Mt. Blocks)

Approvals / Certificates

Ex-Approvals

Logo	Approval	Certificate name
	AEx UL International Germany GmbH c/o Physikalisch Technische Bundesanstalt	E185892
	ATEX Physikalisch Technische Bundesanstalt (PTB)	PTB 98 ATEX 3129 U (II 2 G/D EEx e II)
	IECEX Physikalisch Technische Bundesanstalt (PTB)	IECEX PTB 04.0003U (Ex e IIC Gb)

Country specific Approvals

Logo	Approval	Certificate name
	CSA DEKRA Certification B.V.	70010891



Ship Approvals









Logo	Approval	Certificate name
	LR Lloyds Register	91/20242 (E7)

UL-Approvals

Logo	Approval	Certificate name
	UR Underwriters Laboratories Inc.	E45172, sec. 6

Compatible products

Marking accessories

	Item no.: 2009-145 Mini-WSB Inline; for smartPRINTER; on reel; stretchable 5 - 5.2 mm; plain; snap-on type	www.wago.com/2009-145
	Item no.: 2009-145/000-002 Mini-WSB Inline; for smartPRINTER; on reel; stretchable 5 - 5.2 mm; plain; snap-on type	www.wago.com/2009-145/000-002
	Item no.: 2009-145/000-005 Mini-WSB Inline; for smartPRINTER; on reel; stretchable 5 - 5.2 mm; plain; snap-on type	www.wago.com/2009-145/000-005
	Item no.: 2009-145/000-006 Mini-WSB Inline; for smartPRINTER; on reel; stretchable 5 - 5.2 mm; plain; snap-on type	www.wago.com/2009-145/000-006
	Item no.: 2009-145/000-007 Mini-WSB Inline; for smartPRINTER; on reel; stretchable 5 - 5.2 mm; plain; snap-on type	www.wago.com/2009-145/000-007
	Item no.: 2009-145/000-012 Mini-WSB Inline; for smartPRINTER; on reel; stretchable 5 - 5.2 mm; plain; snap-on type	www.wago.com/2009-145/000-012
	Item no.: 2009-145/000-023 Mini-WSB Inline; for smartPRINTER; on reel; stretchable 5 - 5.2 mm; plain; snap-on type	www.wago.com/2009-145/000-023
	Item no.: 2009-145/000-024 Mini-WSB Inline; on reel; stretchable 5 - 5.2 mm; plain; snap-on type	www.wago.com/2009-145/000-024



Item no.: 209-290
Marker tags; not stretchable; plain; snap-on type

www.wago.com/209-290



Item no.: 248-501
Miniature WSB Quick marking system; plain; Marker width 5 mm; 10 strips with 10 markers per card

www.wago.com/248-501



Item no.: 248-501/000-002
Mini-WSB marking card; as card; not stretchable; plain; snap-on type

www.wago.com/248-501/000-002



Item no.: 248-501/000-005
Mini-WSB marking card; as card; plain; snap-on type

www.wago.com/248-501/000-005



Item no.: 248-501/000-006
Mini-WSB marking card; as card; not stretchable; plain; snap-on type

www.wago.com/248-501/000-006



Item no.: 248-501/000-007
Mini-WSB marking card; as card; not stretchable; plain; snap-on type

www.wago.com/248-501/000-007



Item no.: 248-501/000-012
Mini-WSB marking card; as card; not stretchable; plain; snap-on type

www.wago.com/248-501/000-012



Item no.: 248-501/000-017
Mini-WSB marking card; as card; not stretchable; plain; snap-on type

www.wago.com/248-501/000-017



Item no.: 248-501/000-023
Mini-WSB marking card; as card; not stretchable; plain; snap-on type

www.wago.com/248-501/000-023



Item no.: 248-501/000-024
Mini-WSB marking card; as card; not stretchable; plain; snap-on type

www.wago.com/248-501/000-024

tools



Item no.: 209-130
Operating tool; suitable for 264, 280 and 281 Series; 1-way; of insulating material

www.wago.com/209-130



Item no.: 210-657
Operating tool with partially insulated shaft; Blade (3.5 x 0.5) mm; short

www.wago.com/210-657



Item no.: 210-658
Operating tool with partially insulated shaft; Blade (3.5 x 0.5) mm; short; angled

www.wago.com/210-658



Item no.: 210-720
Operating tool with partially insulated shaft; Type 2, blade (3.5 x 0.5) mm

www.wago.com/210-720



Item no.: 280-432
Operating tool; of insulating material; 2-way

www.wago.com/280-432

Jumper



Item no.: 264-402
Comb-style jumper bar; insulated; 2-way; reduces conductor size to 1.5 mm

www.wago.com/264-402



Item no.: 281-492
Alternate comb-style jumper bar; insulated; 2-way; IN = IN terminal block

www.wago.com/281-492

check



Item no.: 249-136
Test plug module; without locking device; modular; for 2-conductor terminal blocks

www.wago.com/249-136

Carrier rail



Item no.: 210-154
Aluminum carrier rail; 1000 mm long; 18 mm wide; 7 mm high

www.wago.com/210-154

General accessories



Item no.: 209-122
Plastic end stop; for WSB markers; for 210-154 aluminum rail

www.wago.com/209-122

ferrule



Item no.: 216-101
Ferrule; Sleeve for 0.5 mm² / AWG 22; uninsulated; electro-tin plated

www.wago.com/216-101



Item no.: 216-102
Ferrule; Sleeve for 0.75 mm² / AWG 20; uninsulated; electro-tin plated

www.wago.com/216-102



Item no.: 216-103
Ferrule; Sleeve for 1 mm² / AWG 18; uninsulated; electro-tin plated

www.wago.com/216-103



Item no.: 216-104
Ferrule; Sleeve for 1.5 mm² / AWG 16; uninsulated; electro-tin plated

www.wago.com/216-104



Item no.: 216-106
Ferrule; Sleeve for 2.5 mm² / AWG 14; uninsulated; electro-tin plated

www.wago.com/216-106



Item no.: 216-121
Ferrule; Sleeve for 0.5 mm² / AWG 22; uninsulated; electro-tin plated

www.wago.com/216-121



Item no.: 216-122
Ferrule; Sleeve for 0.75 mm² / AWG 20; uninsulated; electro-tin plated

www.wago.com/216-122



Item no.: 216-123
Ferrule; Sleeve for 1 mm² / AWG 18; uninsulated; electro-tin plated

www.wago.com/216-123



Item no.: 216-124
Ferrule; Sleeve for 1.5 mm² / AWG 16; uninsulated; electro-tin plated

www.wago.com/216-124



Item no.: 216-131
Ferrule; Sleeve for 0.25 mm² / AWG 24; uninsulated; electro-tin plated

www.wago.com/216-131











Item no.: 216-132
Ferrule; Sleeve for 0.34 mm² / AWG 24; uninsulated; electro-tin plated

www.wago.com/216-132



Item no.: 216-151
Ferrule; Sleeve for 0.25 mm² / AWG 24; uninsulated; electro-tin plated

www.wago.com/216-151

	Item no.: 216-152 Ferrule; Sleeve for 0.34 mm ² / AWG 24; uninsulated; electro-tin plated	www.wago.com/216-152
	Item no.: 216-201 Ferrule; Sleeve for 0.5 mm ² / AWG 22; insulated; electro-tin plated	www.wago.com/216-201
	Item no.: 216-202 Ferrule; Sleeve for 0.75 mm ² / AWG 20; insulated; electro-tin plated	www.wago.com/216-202
	Item no.: 216-203 Ferrule; Sleeve for 1 mm ² / AWG 18; insulated; electro-tin plated	www.wago.com/216-203
	Item no.: 216-204 Ferrule; Sleeve for 1.5 mm ² / AWG 16; insulated; electro-tin plated	www.wago.com/216-204
	Item no.: 216-205 Ferrule; Sleeve for 2.08 mm ² / AWG 14; insulated; electro-tin plated	www.wago.com/216-205
	Item no.: 216-206 Ferrule; Sleeve for 2.5 mm ² / AWG 14; insulated; electro-tin plated	www.wago.com/216-206
	Item no.: 216-221 Ferrule; Sleeve for 0.5 mm ² / AWG 22; insulated; electro-tin plated	www.wago.com/216-221
	Item no.: 216-222 Ferrule; Sleeve for 0.75 mm ² / AWG 20; insulated; electro-tin plated	www.wago.com/216-222
	Item no.: 216-223 Ferrule; Sleeve for 1 mm ² / AWG 18; insulated; electro-tin plated	www.wago.com/216-223
	Item no.: 216-224 Ferrule; Sleeve for 1.5 mm ² / AWG 16; insulated; electro-tin plated	www.wago.com/216-224
	Item no.: 216-321 Ferrule; Sleeve for 0.25 mm ² / AWG 24; insulated; electro-tin plated	www.wago.com/216-321
	Item no.: 216-322 Ferrule; Sleeve for 0.34 mm ² / AWG 24; insulated; electro-tin plated	www.wago.com/216-322

assembling

	Item no.: 709-153 Cover; Type 1; suitable for cover carrier, type 1; 1 m long	www.wago.com/709-153
--	---	--

Downloads
Documentation

Bid Text

264-192	Oct 11, 2017	DOC 25.6 kB	Download
---------	--------------	----------------	----------



smartDATA

CAD data

3D Download 264-192

URL

Download

Subject to changes.

WAGO Kontakttechnik GmbH & Co. KG

Hansastr. 27

32423 Minden

Phone: +49571 887-0 | Fax: +49571 887-169

Email: info.de@wago.com | Web: www.wago.com

Do you have any questions about our products?

We are always happy to take your call at +49 (571) 887-44222.