

Data sheet | Item number: 280-502/281-594

Terminal block with suppressor diode and end plate; with direct connection to DIN rail; AC 115 V

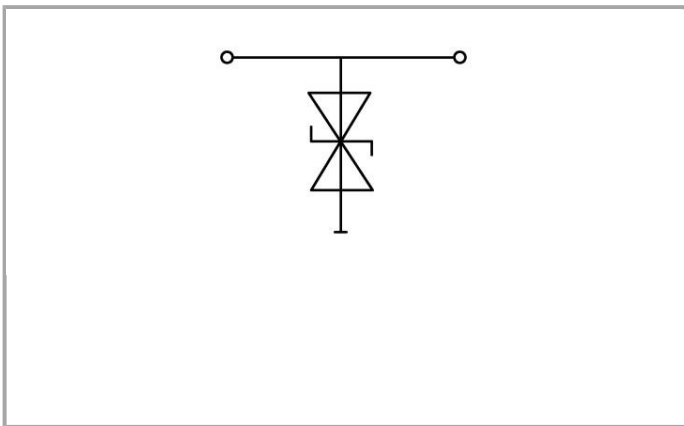

www.wago.com/280-502/281-594

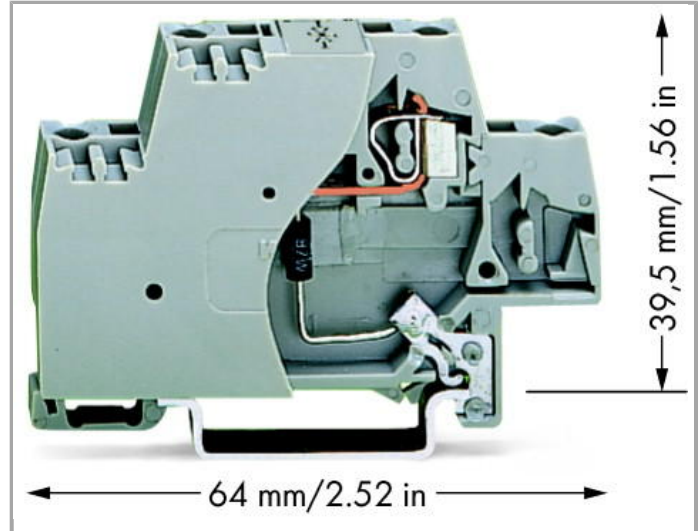
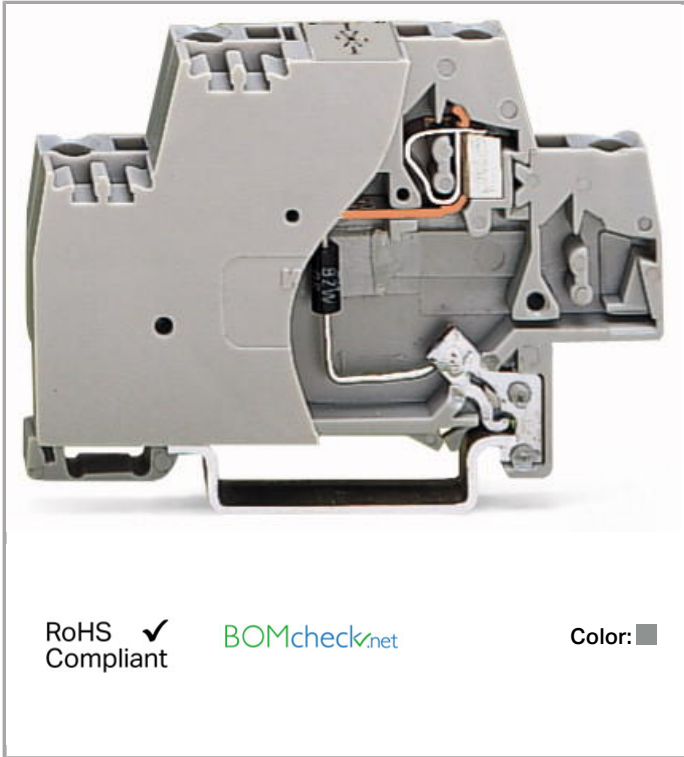

Item description

Short description:

Terminal blocks with surge suppression device and direct connection to the DIN-35 rail; these single-stage surge suppression devices are equipped either with 280 Series gas-filled surge arrester (coarse), varistor (medium) or suppressor diode (fine).

Features:

- Protect your system against overvoltage



- Slim, space-saving design
- Control operational costs by preventing expensive, unplanned downtime
- High operational reliability and system uptime

Data

Electrical data

Nominal operating voltage	115 VAC
Maximum continuous operating voltage	133 VAC
Rated continuous current	20 A
Nominal discharge current (8/20 μ s) per line	26 A
Voltage protection level (8/20 μ s)	\leq 388 VAC
Capacitance	\leq 0.63 nF

Connection data

Connections (number)	2
Connection technology	CAGE CLAMP®
Solid conductor	0.08 ... 2.5 mm ² / 28 ... 14 AWG
Fine-stranded conductor	0.08 ... 2.5 mm ² / 28 ... 14 AWG
Strip length	8 ... 9 mm / 0.31 ... 0.35 Inch

Geometrical Data

Width	10 mm / 0.394 inch
Height from upper-edge of DIN-35 rail	39.5 mm / 1.555 inch
Depth	64 mm / 2.52 inch

Mechanical data

Type of mounting	DIN-35 rail
------------------	-------------

Material Data

Color	gray
Fire load	0.28 MJ
Weight	12.001 g

Commercial data

Country of origin	DE
GTIN	4045454516000
Customs Tariff No.	85369010000
Product Group	1 (Rail Mounted Terminal Blocks)

Compatible products

End plate



Item no.: 280-340
End and intermediate plate; 2.5 mm thick

www.wago.com/280-340



Item no.: 280-341
End and intermediate plate; 2.5 mm thick

www.wago.com/280-341

Jumper



Item no.: 280-482
Comb-style jumper bar; insulated; 2-way; IN = IN terminal block

www.wago.com/280-482



Item no.: 280-483
Comb-style jumper bar; insulated; 3-way; IN = IN terminal block

www.wago.com/280-483



Item no.: 280-484
Comb-style jumper bar; insulated; 4-way; IN = IN terminal block

www.wago.com/280-484



Item no.: 280-485
Comb-style jumper bar; insulated; 5-way; IN = IN terminal block

www.wago.com/280-485



Item no.: 280-490
Comb-style jumper bar; insulated; 10-way; IN = IN terminal block

www.wago.com/280-490



Item no.: 280-492
Alternate comb-style jumper bar; insulated; 2-way; IN = IN terminal block

www.wago.com/280-492

Insulation stop



Item no.: 280-470
Insulation stop; 0.08 - 0.2 mm² "s" (0.14 mm² "f-st"); 5 pieces/strip

www.wago.com/280-470



Item no.: 280-471
Insulation stop; 0.25 - 0.5 mm²; 5 pieces/strip

www.wago.com/280-471



Item no.: 280-472
Insulation stop; 0.75 - 1 mm²; 5 pieces/strip

www.wago.com/280-472

tools



Item no.: 210-720
Operating tool with partially insulated shaft; Type 2, blade (3.5 x 0.5) mm

www.wago.com/210-720

Marking accessories



Item no.: 2009-145
Mini-WSB Inline; for smartPRINTER; on reel; stretchable 5 - 5.2 mm; plain; snap-on type

www.wago.com/2009-145

















Item no.: 2009-145/000-002
Mini-WSB Inline; for smartPRINTER; on reel; stretchable 5 - 5.2 mm; plain; snap-on type

www.wago.com/2009-145/000-002



Item no.: 2009-145/000-005
Mini-WSB Inline; for smartPRINTER; on reel; stretchable 5 - 5.2 mm; plain; snap-on type

www.wago.com/2009-145/000-005

	<p>Item no.: 2009-145/000-006 Mini-WSB Inline; for smartPRINTER; on reel; stretchable 5 - 5.2 mm; plain; snap-on type</p>	<p>www.wago.com/2009-145/000-006</p>
	<p>Item no.: 2009-145/000-007 Mini-WSB Inline; for smartPRINTER; on reel; stretchable 5 - 5.2 mm; plain; snap-on type</p>	<p>www.wago.com/2009-145/000-007</p>
	<p>Item no.: 2009-145/000-012 Mini-WSB Inline; for smartPRINTER; on reel; stretchable 5 - 5.2 mm; plain; snap-on type</p>	<p>www.wago.com/2009-145/000-012</p>
	<p>Item no.: 2009-145/000-023 Mini-WSB Inline; for smartPRINTER; on reel; stretchable 5 - 5.2 mm; plain; snap-on type</p>	<p>www.wago.com/2009-145/000-023</p>
	<p>Item no.: 2009-145/000-024 Mini-WSB Inline; on reel; stretchable 5 - 5.2 mm; plain; snap-on type</p>	<p>www.wago.com/2009-145/000-024</p>
	<p>Item no.: 248-501 Miniature WSB Quick marking system; plain; Marker width 5 mm; 10 strips with 10 markers per card</p>	<p>www.wago.com/248-501</p>
	<p>Item no.: 248-501/000-002 Mini-WSB marking card; as card; not stretchable; plain; snap-on type</p>	<p>www.wago.com/248-501/000-002</p>
	<p>Item no.: 248-501/000-005 Mini-WSB marking card; as card; plain; snap-on type</p>	<p>www.wago.com/248-501/000-005</p>
	<p>Item no.: 248-501/000-006 Mini-WSB marking card; as card; not stretchable; plain; snap-on type</p>	<p>www.wago.com/248-501/000-006</p>
	<p>Item no.: 248-501/000-007 Mini-WSB marking card; as card; not stretchable; plain; snap-on type</p>	<p>www.wago.com/248-501/000-007</p>
	<p>Item no.: 248-501/000-012 Mini-WSB marking card; as card; not stretchable; plain; snap-on type</p>	<p>www.wago.com/248-501/000-012</p>
	<p>Item no.: 248-501/000-017 Mini-WSB marking card; as card; not stretchable; plain; snap-on type</p>	<p>www.wago.com/248-501/000-017</p>
	<p>Item no.: 248-501/000-023 Mini-WSB marking card; as card; not stretchable; plain; snap-on type</p>	<p>www.wago.com/248-501/000-023</p>
	<p>Item no.: 248-501/000-024 Mini-WSB marking card; as card; not stretchable; plain; snap-on type</p>	<p>www.wago.com/248-501/000-024</p>



Downloads

Documentation

Additional Information

Disposal; Electrical and electronic equipment, Packaging	Oct 15, 2018	265.8 kB	Download
--	--------------	----------	----------

smartDATA

CAD data

3D Download 280-502/281-594	URL	Download
-----------------------------	-----	----------

Subject to changes.