

Data sheet | Item number: 280-502/281-607

Terminal block with suppressor diode; with direct connection to DIN rail; AC 115 V

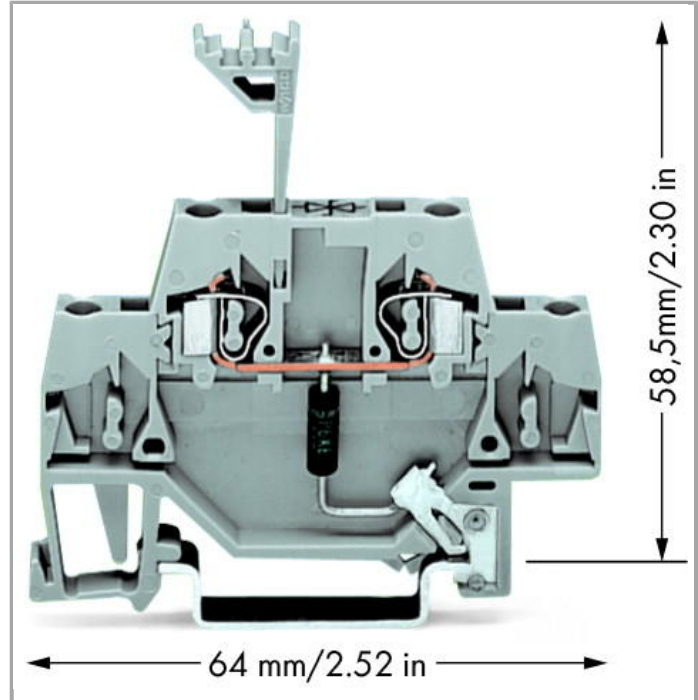

[www.wago.com/280-502/281-607](http://www.wago.com/280-502/281-607)

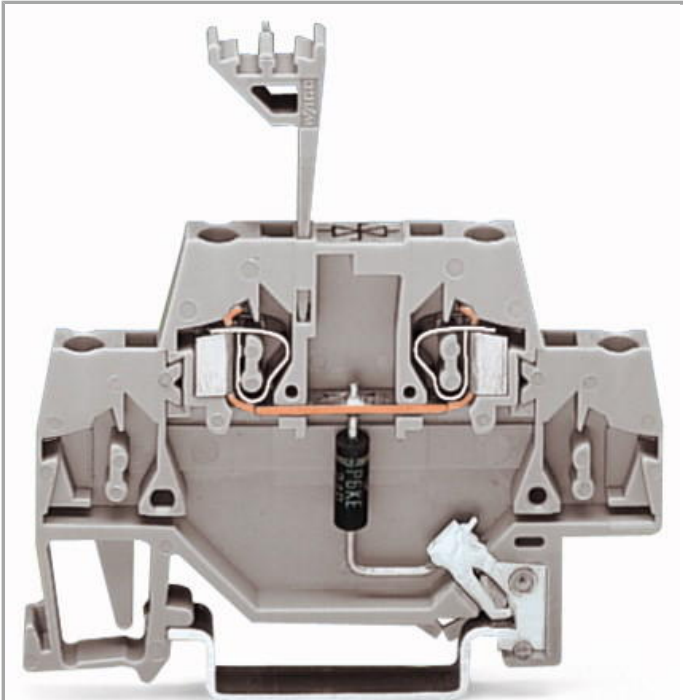

RoHS  Compliant

[BOMcheck.net](https://www.bomcheck.net)

Color: ■

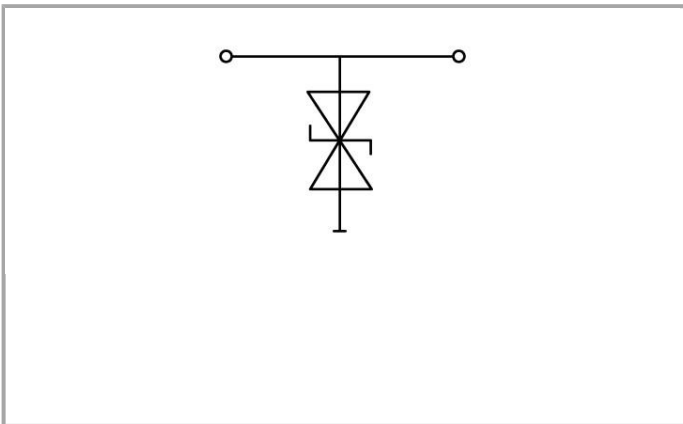

Item description

Short description:



Terminal blocks with surge suppression device and direct connection to the DIN-35 rail; these single-stage surge suppression devices are equipped either with 280 Series gas-filled surge arrester (coarse), varistor (medium) or suppressor diode (fine).

#### Features:

- Protect your system against overvoltage
- Slim, space-saving design
- Control operational costs by preventing expensive, unplanned downtime
- High operational reliability and system uptime

## Data

### Electrical data

Nominal operating voltage	115 VAC
Maximum continuous operating voltage	133 VAC
Rated continuous current	20 A
Nominal discharge current (10/1000 $\mu$ s) per line	1.7 A
Voltage protection level (10/1000 $\mu$ s)	$\leq$ 384 VAC
Capacitance	$\leq$ 0.36 nF

### Connection data

Connections (number)	2
Connection technology	CAGE CLAMP®
Solid conductor	0.08 ... 2.5 mm <sup>2</sup> / 28 ... 14 AWG
Fine-stranded conductor	0.08 ... 2.5 mm <sup>2</sup> / 28 ... 14 AWG
Strip length	8 ... 9 mm / 0.31 ... 0.35 Inch

### Geometrical Data

Width	5 mm / 0.197 inch
Height from upper-edge of DIN-35 rail	58.5 mm / 2.303 inch
Depth	64 mm / 2.52 inch

### Mechanical data

Type of mounting	DIN-35 rail
------------------	-------------

### Material Data



Color	gray
Fire load	0.172 MJ
Weight	8.101 g

## Commercial data







Country of origin	DE
GTIN	4050821860976
Customs Tariff No.	85369010000
Product Group	1 (Rail Mounted Terminal Blocks)

## Compatible products





### Insulation stop















	<b>Item no.: 280-470</b> Insulation stop; 0.08 - 0.2 mm <sup>2</sup> "s" (0.14 mm <sup>2</sup> "f-st"); 5 pieces/strip	<a href="http://www.wago.com/280-470">www.wago.com/280-470</a>
	<b>Item no.: 280-471</b> Insulation stop; 0.25 - 0.5 mm <sup>2</sup> ; 5 pieces/strip	<a href="http://www.wago.com/280-471">www.wago.com/280-471</a>
	<b>Item no.: 280-472</b> Insulation stop; 0.75 - 1 mm <sup>2</sup> ; 5 pieces/strip	<a href="http://www.wago.com/280-472">www.wago.com/280-472</a>

### Jumper

	<b>Item no.: 280-482</b> Comb-style jumper bar; insulated; 2-way; IN = IN terminal block	<a href="http://www.wago.com/280-482">www.wago.com/280-482</a>
	<b>Item no.: 280-483</b> Comb-style jumper bar; insulated; 3-way; IN = IN terminal block	<a href="http://www.wago.com/280-483">www.wago.com/280-483</a>
	<b>Item no.: 280-484</b> Comb-style jumper bar; insulated; 4-way; IN = IN terminal block	<a href="http://www.wago.com/280-484">www.wago.com/280-484</a>
	<b>Item no.: 280-485</b> Comb-style jumper bar; insulated; 5-way; IN = IN terminal block	<a href="http://www.wago.com/280-485">www.wago.com/280-485</a>
	<b>Item no.: 280-490</b> Comb-style jumper bar; insulated; 10-way; IN = IN terminal block	<a href="http://www.wago.com/280-490">www.wago.com/280-490</a>
	<b>Item no.: 280-492</b> Alternate comb-style jumper bar; insulated; 2-way; IN = IN terminal block	<a href="http://www.wago.com/280-492">www.wago.com/280-492</a>

### Marking accessories

	<b>Item no.: 2009-115</b> WMB-Inline; for smartPRINTER; on reel; stretchable 5 - 5.2 mm; plain; snap-on type	<a href="http://www.wago.com/2009-115">www.wago.com/2009-115</a>
	<b>Item no.: 2009-115/000-002</b> WMB-Inline; for smartPRINTER; on reel; stretchable 5 - 5.2 mm; plain; snap-on type	<a href="http://www.wago.com/2009-115/000-002">www.wago.com/2009-115/000-002</a>
	<b>Item no.: 2009-115/000-006</b> WMB-Inline; for smartPRINTER; on reel; stretchable 5 - 5.2 mm; plain; snap-on type	<a href="http://www.wago.com/2009-115/000-006">www.wago.com/2009-115/000-006</a>
	<b>Item no.: 2009-115/000-007</b> WMB-Inline; for smartPRINTER; on reel; stretchable 5 - 5.2 mm; plain; snap-on type	<a href="http://www.wago.com/2009-115/000-007">www.wago.com/2009-115/000-007</a>

	<b>Item no.: 2009-115/000-012</b> WMB-Inline; for smartPRINTER; on reel; stretchable 5 - 5.2 mm; plain; snap-on type	<a href="http://www.wago.com/2009-115/000-012">www.wago.com/2009-115/000-012</a>
	<b>Item no.: 2009-115/000-017</b> WMB-Inline; for smartPRINTER; on reel; stretchable 5 - 5.2 mm; plain; snap-on type	<a href="http://www.wago.com/2009-115/000-017">www.wago.com/2009-115/000-017</a>
	<b>Item no.: 2009-115/000-023</b> WMB-Inline; for smartPRINTER; on reel; stretchable 5 - 5.2 mm; plain; snap-on type	<a href="http://www.wago.com/2009-115/000-023">www.wago.com/2009-115/000-023</a>
	<b>Item no.: 2009-115/000-024</b> WMB-Inline; for smartPRINTER; on reel; stretchable 5 - 5.2 mm; plain; snap-on type	<a href="http://www.wago.com/2009-115/000-024">www.wago.com/2009-115/000-024</a>
	<b>Item no.: 793-501</b> WMB marking card; as card; not stretchable; plain; snap-on type	<a href="http://www.wago.com/793-501">www.wago.com/793-501</a>
	<b>Item no.: 793-501/000-002</b> WMB marking card; as card; not stretchable; plain; snap-on type	<a href="http://www.wago.com/793-501/000-002">www.wago.com/793-501/000-002</a>
	<b>Item no.: 793-501/000-005</b> WMB marking card; as card; not stretchable; plain; snap-on type	<a href="http://www.wago.com/793-501/000-005">www.wago.com/793-501/000-005</a>
	<b>Item no.: 793-501/000-006</b> WMB marking card; as card; not stretchable; plain; snap-on type	<a href="http://www.wago.com/793-501/000-006">www.wago.com/793-501/000-006</a>
	<b>Item no.: 793-501/000-007</b> WMB marking card; as card; not stretchable; plain; snap-on type	<a href="http://www.wago.com/793-501/000-007">www.wago.com/793-501/000-007</a>
	<b>Item no.: 793-501/000-012</b> WMB marking card; as card; not stretchable; plain; snap-on type	<a href="http://www.wago.com/793-501/000-012">www.wago.com/793-501/000-012</a>
	<b>Item no.: 793-501/000-017</b> WMB marking card; as card; not stretchable; plain; snap-on type	<a href="http://www.wago.com/793-501/000-017">www.wago.com/793-501/000-017</a>
	<b>Item no.: 793-501/000-023</b> WMB marking card; as card; not stretchable; plain; snap-on type	<a href="http://www.wago.com/793-501/000-023">www.wago.com/793-501/000-023</a>
	<b>Item no.: 793-501/000-024</b> WMB marking card; as card; not stretchable; plain; snap-on type	<a href="http://www.wago.com/793-501/000-024">www.wago.com/793-501/000-024</a>
	<b>Item no.: 793-502</b> WMB marking card; as card; MARKED; 1 ... 10 (10x); not stretchable; Horizontal marking; snap-on type	<a href="http://www.wago.com/793-502">www.wago.com/793-502</a>
	<b>Item no.: 793-502/000-002</b> WMB marking card; as card; MARKED; 1 ... 10 (10x); not stretchable; Horizontal marking; snap-on type	<a href="http://www.wago.com/793-502/000-002">www.wago.com/793-502/000-002</a>



**Item no.: 793-502/000-005**  
WMB marking card; as card; MARKED; 1 ... 10 (10x); not stretchable; Horizontal marking; snap-on type

[www.wago.com/793-502/000-005](http://www.wago.com/793-502/000-005)



**Item no.: 793-502/000-006**  
WMB marking card; as card; MARKED; 1 ... 10 (10x); not stretchable; Horizontal marking; snap-on type

[www.wago.com/793-502/000-006](http://www.wago.com/793-502/000-006)



**Item no.: 793-502/000-007**  
WMB marking card; as card; MARKED; 1 ... 10 (10x); not stretchable; Horizontal marking; snap-on type

[www.wago.com/793-502/000-007](http://www.wago.com/793-502/000-007)



**Item no.: 793-502/000-012**  
WMB marking card; as card; MARKED; 1 ... 10 (10x); not stretchable; Horizontal marking; snap-on type

[www.wago.com/793-502/000-012](http://www.wago.com/793-502/000-012)



**Item no.: 793-502/000-017**  
WMB marking card; as card; MARKED; 1 ... 10 (10x); not stretchable; Horizontal marking; snap-on type

[www.wago.com/793-502/000-017](http://www.wago.com/793-502/000-017)



**Item no.: 793-502/000-023**  
WMB marking card; as card; MARKED; 1 ... 10 (10x); not stretchable; Horizontal marking; snap-on type

[www.wago.com/793-502/000-023](http://www.wago.com/793-502/000-023)



**Item no.: 793-502/000-024**  
WMB marking card; as card; MARKED; 1 ... 10 (10x); not stretchable; Horizontal marking; snap-on type

[www.wago.com/793-502/000-024](http://www.wago.com/793-502/000-024)



**Item no.: 793-503**  
WMB marking card; as card; MARKED; 11 ... 20 (10x); not stretchable; Horizontal marking; snap-on type

[www.wago.com/793-503](http://www.wago.com/793-503)



**Item no.: 793-503/000-002**  
WMB marking card; as card; MARKED; 11 ... 20 (10x); not stretchable; Horizontal marking; snap-on type

[www.wago.com/793-503/000-002](http://www.wago.com/793-503/000-002)



**Item no.: 793-503/000-005**  
WMB marking card; as card; MARKED; 11 ... 20 (10x); not stretchable; Horizontal marking; snap-on type

[www.wago.com/793-503/000-005](http://www.wago.com/793-503/000-005)



**Item no.: 793-503/000-006**  
WMB marking card; as card; MARKED; 11 ... 20 (10x); not stretchable; Horizontal marking; snap-on type

[www.wago.com/793-503/000-006](http://www.wago.com/793-503/000-006)



**Item no.: 793-503/000-007**  
WMB marking card; as card; MARKED; 11 ... 20 (10x); not stretchable; Horizontal marking; snap-on type

[www.wago.com/793-503/000-007](http://www.wago.com/793-503/000-007)



**Item no.: 793-503/000-012**  
WMB marking card; as card; MARKED; 11 ... 20 (10x); not stretchable; Horizontal marking; snap-on type

[www.wago.com/793-503/000-012](http://www.wago.com/793-503/000-012)



**Item no.: 793-503/000-017**  
WMB marking card; as card; MARKED; 11 ... 20 (10x); not stretchable; Horizontal marking; snap-on type

[www.wago.com/793-503/000-017](http://www.wago.com/793-503/000-017)



**Item no.: 793-503/000-023**  
WMB marking card; as card; MARKED; 11 ... 20 (10x); not stretchable; Horizontal marking; snap-on type

[www.wago.com/793-503/000-023](http://www.wago.com/793-503/000-023)



**Item no.: 793-503/000-024**

WMB marking card; as card; MARKED; 11 ... 20 (10x); not stretchable; Horizontal marking; snap-on type

[www.wago.com/793-503/000-024](http://www.wago.com/793-503/000-024)



**Item no.: 793-504**

WMB marking card; as card; MARKED; 21 ... 30 (10x); not stretchable; Horizontal marking; snap-on type

[www.wago.com/793-504](http://www.wago.com/793-504)



**Item no.: 793-504/000-002**

WMB marking card; as card; MARKED; 21 ... 30 (10x); not stretchable; Horizontal marking; snap-on type

[www.wago.com/793-504/000-002](http://www.wago.com/793-504/000-002)



**Item no.: 793-504/000-005**

WMB marking card; as card; MARKED; 21 ... 30 (10x); not stretchable; Horizontal marking; snap-on type

[www.wago.com/793-504/000-005](http://www.wago.com/793-504/000-005)



**Item no.: 793-504/000-006**

WMB marking card; as card; MARKED; 21 ... 30 (10x); not stretchable; Horizontal marking; snap-on type

[www.wago.com/793-504/000-006](http://www.wago.com/793-504/000-006)



**Item no.: 793-504/000-012**

WMB marking card; as card; MARKED; 21 ... 30 (10x); not stretchable; Horizontal marking; snap-on type

[www.wago.com/793-504/000-012](http://www.wago.com/793-504/000-012)



**Item no.: 793-504/000-017**

WMB marking card; as card; MARKED; 21 ... 30 (10x); not stretchable; Horizontal marking; snap-on type

[www.wago.com/793-504/000-017](http://www.wago.com/793-504/000-017)



**Item no.: 793-504/000-023**

WMB marking card; as card; MARKED; 21 ... 30 (10x); not stretchable; Horizontal marking; snap-on type

[www.wago.com/793-504/000-023](http://www.wago.com/793-504/000-023)



**Item no.: 793-505**

WMB marking card; as card; MARKED; 31 ... 40 (10x); not stretchable; Horizontal marking; snap-on type

[www.wago.com/793-505](http://www.wago.com/793-505)



**Item no.: 793-505/000-005**

WMB marking card; as card; MARKED; 31 ... 40 (10x); not stretchable; Horizontal marking; snap-on type

[www.wago.com/793-505/000-005](http://www.wago.com/793-505/000-005)



**Item no.: 793-505/000-006**

WMB marking card; as card; MARKED; 31 ... 40 (10x); not stretchable; Horizontal marking; snap-on type

[www.wago.com/793-505/000-006](http://www.wago.com/793-505/000-006)



**Item no.: 793-505/000-007**

WMB marking card; as card; MARKED; 31 ... 40 (10x); not stretchable; Horizontal marking; snap-on type

[www.wago.com/793-505/000-007](http://www.wago.com/793-505/000-007)



**Item no.: 793-505/000-012**

WMB marking card; as card; MARKED; 31 ... 40 (10x); not stretchable; Horizontal marking; snap-on type

[www.wago.com/793-505/000-012](http://www.wago.com/793-505/000-012)



**Item no.: 793-506**

WMB marking card; as card; MARKED; 41 ... 50 (10x); not stretchable; Horizontal marking; snap-on type

[www.wago.com/793-506](http://www.wago.com/793-506)



**Item no.: 793-506/000-005**

WMB marking card; as card; MARKED; 41 ... 50 (10x); not stretchable; Horizontal marking; snap-on type

[www.wago.com/793-506/000-005](http://www.wago.com/793-506/000-005)



Item no.: 793-506/000-006

WMB marking card; as card; MARKED; 41 ... 50 (10x); not stretchable; Horizontal marking; snap-on type [www.wago.com/793-506/000-006](http://www.wago.com/793-506/000-006)



Item no.: 793-506/000-012

WMB marking card; as card; MARKED; 41 ... 50 (10x); not stretchable; Horizontal marking; snap-on type [www.wago.com/793-506/000-012](http://www.wago.com/793-506/000-012)



Item no.: 793-506/000-017

WMB marking card; as card; MARKED; 41 ... 50 (10x); not stretchable; Horizontal marking; snap-on type [www.wago.com/793-506/000-017](http://www.wago.com/793-506/000-017)

#### tools



Item no.: 210-720

Operating tool with partially insulated shaft; Type 2, blade (3.5 x 0.5) mm

[www.wago.com/210-720](http://www.wago.com/210-720)

#### End plate



Item no.: 280-340

End and intermediate plate; 2.5 mm thick

[www.wago.com/280-340](http://www.wago.com/280-340)



Item no.: 280-341

End and intermediate plate; 2.5 mm thick

[www.wago.com/280-341](http://www.wago.com/280-341)

#### Downloads

##### Documentation

##### Additional Information

Disposal; Electrical and electronic equipment, Packaging

Oct 15, 2018

Download

265.8 kB

#### smartDATA

##### CAD data

3D Download 280-502/281-607

URL

Download

Subject to changes.

WAGO Kontakttechnik GmbH & Co. KG

Hansastr. 27

32423 Minden

Phone: +49571 887-0 | Fax: +49571 887-169

Email: [info.de@wago.com](mailto:info.de@wago.com) | Web: [www.wago.com](http://www.wago.com)

Do you have any questions about our products?

We are always happy to take your call at +49 (571) 887-44222.