

Data sheet | Item number: 280-649

4-conductor disconnect/test terminal block; without pivoting knife disconnect; with touch-proof test sockets; Test socket, red; for DIN-rail 35 x 15 and 35 x 7.5; 2.5 mm²; CAGE CLAMP®

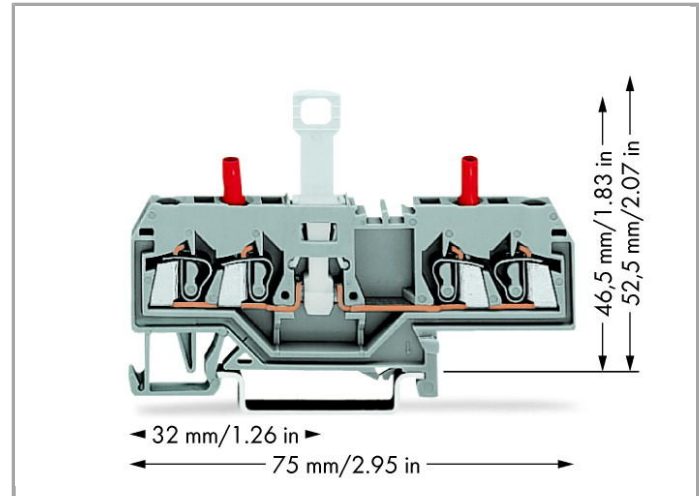

www.wago.com/280-649

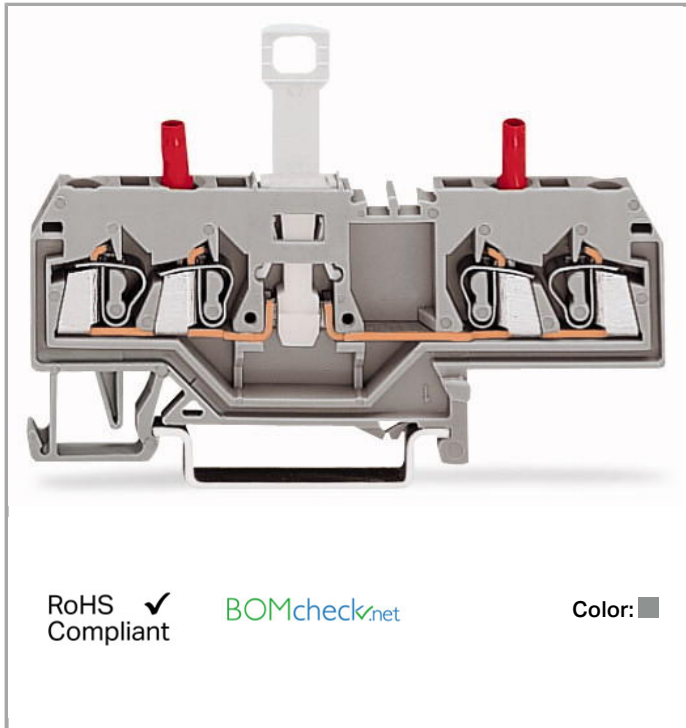

RoHS Compliant

[BOMcheck.net](https://www.bomcheck.net)

Color: ■

Data

Electrical data

Ratings per IEC/EN 60664-1

Rated voltage (III / 3)	400 V
Rated impulse voltage (III / 3)	6 kV
Rated current	10 A
Legend (ratings)	(III / 3) ≙ Overvoltage category III / Pollution degree 3

Connection data

Connection technology	CAGE CLAMP®
Actuation type	Operating tool
Connectable conductor materials	Copper Aluminum
Solid conductor	0.08 ... 2.5 mm ² / 28 ... 12 AWG
Fine-stranded conductor	0.08 ... 2.5 mm ² / 28 ... 12 AWG
Strip length	8 ... 9 mm / 0.31 ... 0.35 Inch
Total number of connection points	2

Total number of potentials	2
Number of levels	1
Type of wiring	Front-entry wiring

Geometrical Data

Width	5 mm / 0.197 inch
Height from upper-edge of DIN-35 rail	52.5 mm / 2.067 inch
Depth	53 mm / 2.087 inch

Mechanical data

Design	horizontal
Type of mounting	DIN-35 rail
Marking level	Center marking

Material Data

Color	gray
Insulating material	Polyamide 66 (PA 66)
Weight	10.916 g

Commercial data

Country of origin	DE
GTIN	4044918691369
Customs Tariff No.	85369010000
Product Group	1 (Rail Mounted Terminal Blocks)

Approvals / Certificates

Country specific Approvals

Logo	Approval	Certificate name
	CCA DEKRA Certification B.V.	2157201.01

Ship Approvals

Logo	Approval	Certificate name
	ABS American Bureau of Shipping	14-HG1293677-PDA
	BV Bureau Veritas S.A.	07436/E0 BV

BV



LR
Lloyds Register

91/20112 (E9)

Compatible products

assembling



Item no.: 209-106
Mounting carrier; for isolated mounting on DIN 35 rails

www.wago.com/209-106



Item no.: 210-148
Angled support bracket; without screw

www.wago.com/210-148



Item no.: 709-153
Cover; Type 1; suitable for cover carrier, type 1; 1 m long

www.wago.com/709-153

End plate



Item no.: 280-314
End and intermediate plate; 2.5 mm thick

www.wago.com/280-314



Item no.: 280-315
End and intermediate plate; 2.5 mm thick

www.wago.com/280-315



Item no.: 280-334
Separator plate; 2 mm thick; oversized

www.wago.com/280-334



Item no.: 280-335
Separator plate; 2 mm thick; oversized

www.wago.com/280-335

General accessories



Item no.: 231-162/003-000
Male connector for rail-mount terminal blocks; 1.2 x 1.2 mm pins; straight; Pin spacing 5 mm; 2-pole

www.wago.com/231-162/003-000



Item no.: 231-163/003-000
Male connector for rail-mount terminal blocks; 1.2 x 1.2 mm pins; straight; Pin spacing 5 mm; 3-pole

www.wago.com/231-163/003-000



Item no.: 231-164/003-000
Male connector for rail-mount terminal blocks; 1.2 x 1.2 mm pins; straight; Pin spacing 5 mm; 4-pole

www.wago.com/231-164/003-000



Item no.: 231-165/003-000
Male connector for rail-mount terminal blocks; 1.2 x 1.2 mm pins; straight; Pin spacing 5 mm; 5-pole

www.wago.com/231-165/003-000

**Item no.: 231-166/003-000**

Male connector for rail-mount terminal blocks; 1.2 x 1.2 mm pins; straight; Pin spacing 5 mm; 6-pole

www.wago.com/231-166/003-000**Item no.: 231-167/003-000**

Male connector for rail-mount terminal blocks; 1.2 x 1.2 mm pins; straight; Pin spacing 5 mm; 7-pole

www.wago.com/231-167/003-000**Item no.: 231-168/003-000**

Male connector for rail-mount terminal blocks; 1.2 x 1.2 mm pins; straight; Pin spacing 5 mm; 8-pole

www.wago.com/231-168/003-000**Item no.: 231-169/003-000**

Male connector for rail-mount terminal blocks; 1.2 x 1.2 mm pins; straight; Pin spacing 5 mm; 9-pole

www.wago.com/231-169/003-000**Item no.: 231-170/003-000**

Male connector for rail-mount terminal blocks; 1.2 x 1.2 mm pins; straight; Pin spacing 5 mm; 10-pole

www.wago.com/231-170/003-000**Item no.: 231-171/003-000**

Male connector for rail-mount terminal blocks; 1.2 x 1.2 mm pins; straight; Pin spacing 5 mm; 11-pole

www.wago.com/231-171/003-000**Item no.: 231-172/003-000**

Male connector for rail-mount terminal blocks; 1.2 x 1.2 mm pins; straight; Pin spacing 5 mm; 12-pole

www.wago.com/231-172/003-000**Item no.: 231-176/003-000**

Male connector for rail-mount terminal blocks; 1.2 x 1.2 mm pins; straight; Pin spacing 5 mm; 16-pole

www.wago.com/231-176/003-000**Item no.: 231-180/003-000**

Male connector for rail-mount terminal blocks; 1.2 x 1.2 mm pins; straight; Pin spacing 5 mm; 20-pole

www.wago.com/231-180/003-000**Item no.: 231-668**

Lockout caps; for covering unused clamping units

www.wago.com/231-668**Item no.: 231-669**

Lockout caps; for covering unused clamping units

www.wago.com/231-669**Item no.: 249-105**

Group marker carrier

www.wago.com/249-105**Item no.: 709-170**

Disconnect lock; for disconnect tab used on 280/281 and 769 Series disconnect terminal blocks

www.wago.com/709-170

Marking accessories















**Item no.: 2009-115**















WMB-Inline; for smartPRINTER; on reel; stretchable 5 - 5.2 mm; plain; snap-on type















www.wago.com/2009-115**Item no.: 2009-115/000-002**

WMB-Inline; for smartPRINTER; on reel; stretchable 5 - 5.2 mm; plain; snap-on type

www.wago.com/2009-115/000-002

	<p>Item no.: 2009-115/000-006 WMB-Inline; for smartPRINTER; on reel; stretchable 5 - 5.2 mm; plain; snap-on type</p>	www.wago.com/2009-115/000-006
	<p>Item no.: 2009-115/000-007 WMB-Inline; for smartPRINTER; on reel; stretchable 5 - 5.2 mm; plain; snap-on type</p>	www.wago.com/2009-115/000-007
	<p>Item no.: 2009-115/000-012 WMB-Inline; for smartPRINTER; on reel; stretchable 5 - 5.2 mm; plain; snap-on type</p>	www.wago.com/2009-115/000-012
	<p>Item no.: 2009-115/000-017 WMB-Inline; for smartPRINTER; on reel; stretchable 5 - 5.2 mm; plain; snap-on type</p>	www.wago.com/2009-115/000-017
	<p>Item no.: 2009-115/000-023 WMB-Inline; for smartPRINTER; on reel; stretchable 5 - 5.2 mm; plain; snap-on type</p>	www.wago.com/2009-115/000-023
	<p>Item no.: 2009-115/000-024 WMB-Inline; for smartPRINTER; on reel; stretchable 5 - 5.2 mm; plain; snap-on type</p>	www.wago.com/2009-115/000-024
	<p>Item no.: 793-501 WMB marking card; as card; not stretchable; plain; snap-on type</p>	www.wago.com/793-501
	<p>Item no.: 793-501/000-002 WMB marking card; as card; not stretchable; plain; snap-on type</p>	www.wago.com/793-501/000-002
	<p>Item no.: 793-501/000-005 WMB marking card; as card; not stretchable; plain; snap-on type</p>	www.wago.com/793-501/000-005
	<p>Item no.: 793-501/000-006 WMB marking card; as card; not stretchable; plain; snap-on type</p>	www.wago.com/793-501/000-006
	<p>Item no.: 793-501/000-007 WMB marking card; as card; not stretchable; plain; snap-on type</p>	www.wago.com/793-501/000-007
	<p>Item no.: 793-501/000-012 WMB marking card; as card; not stretchable; plain; snap-on type</p>	www.wago.com/793-501/000-012
	<p>Item no.: 793-501/000-017 WMB marking card; as card; not stretchable; plain; snap-on type</p>	www.wago.com/793-501/000-017
	<p>Item no.: 793-501/000-023 WMB marking card; as card; not stretchable; plain; snap-on type</p>	www.wago.com/793-501/000-023
	<p>Item no.: 793-501/000-024 WMB marking card; as card; not stretchable; plain; snap-on type</p>	www.wago.com/793-501/000-024

	Item no.: 793-5501 WMB marking card; as card; for terminal block width 5 - 17.5 mm; stretchable 5 - 5.2 mm; plain; snap-on type	www.wago.com/793-5501
	Item no.: 793-5501/000-002 WMB marking card; as card; for terminal block width 5 - 17.5 mm; stretchable 5 - 5.2 mm; plain; snap-on type	www.wago.com/793-5501/000-002
	Item no.: 793-5501/000-005 WMB marking card; as card; stretchable 5 - 5.2 mm; plain; snap-on type	www.wago.com/793-5501/000-005
	Item no.: 793-5501/000-006 WMB marking card; as card; stretchable 5 - 5.2 mm; plain; snap-on type	www.wago.com/793-5501/000-006
	Item no.: 793-5501/000-007 WMB marking card; as card; stretchable 5 - 5.2 mm; plain; snap-on type	www.wago.com/793-5501/000-007
	Item no.: 793-5501/000-012 WMB marking card; as card; stretchable 5 - 5.2 mm; plain; snap-on type	www.wago.com/793-5501/000-012
	Item no.: 793-5501/000-017 WMB marking card; as card; stretchable 5 - 5.2 mm; plain; snap-on type	www.wago.com/793-5501/000-017
	Item no.: 793-5501/000-023 WMB marking card; as card; stretchable 5 - 5.2 mm; plain; snap-on type	www.wago.com/793-5501/000-023
	Item no.: 793-5501/000-024 WMB marking card; as card; stretchable 5 - 5.2 mm; plain; snap-on type	www.wago.com/793-5501/000-024
tools		
	Item no.: 210-657 Operating tool with partially insulated shaft; Blade (3.5 x 0.5) mm; short	www.wago.com/210-657
	Item no.: 210-658 Operating tool with partially insulated shaft; Blade (3.5 x 0.5) mm; short; angled	www.wago.com/210-658
	Item no.: 210-720 Operating tool with partially insulated shaft; Type 2, blade (3.5 x 0.5) mm	www.wago.com/210-720
Female plug		
	Item no.: 232-132/005-000 Female connector for rail-mount terminal blocks; straight; Pin spacing 5 mm; 2-pole	www.wago.com/232-132/005-000
	Item no.: 232-132/005-000/039-000 Female connector for rail-mount terminal blocks; straight; Locking lever; Pin spacing 5 mm; 3-pole	www.wago.com/232-132/005-000/039-000

	Item no.: 232-133/005-000 Female connector for rail-mount terminal blocks; straight; Pin spacing 5 mm; 3-pole	www.wago.com/232-133/005-000
	Item no.: 232-133/005-000/039-000 Female connector for rail-mount terminal blocks; straight; Locking lever; Pin spacing 5 mm; 3-pole	www.wago.com/232-133/005-000/039-000
	Item no.: 232-134/005-000 Female connector for rail-mount terminal blocks; straight; Pin spacing 5 mm; 4-pole	www.wago.com/232-134/005-000
	Item no.: 232-134/005-000/039-000 Female connector for rail-mount terminal blocks; straight; Locking lever; Pin spacing 5 mm; 4-pole	www.wago.com/232-134/005-000/039-000
	Item no.: 232-135/005-000 Female connector for rail-mount terminal blocks; straight; Pin spacing 5 mm; 5-pole	www.wago.com/232-135/005-000
	Item no.: 232-135/005-000/039-000 Female connector for rail-mount terminal blocks; straight; Locking lever; Pin spacing 5 mm; 5-pole	www.wago.com/232-135/005-000/039-000
	Item no.: 232-136/005-000 Female connector for rail-mount terminal blocks; straight; Pin spacing 5 mm; 6-pole	www.wago.com/232-136/005-000
	Item no.: 232-136/005-000/039-000 Female connector for rail-mount terminal blocks; straight; Locking lever; Pin spacing 5 mm; 6-pole	www.wago.com/232-136/005-000/039-000
	Item no.: 232-137/005-000 Female connector for rail-mount terminal blocks; straight; Pin spacing 5 mm; 7-pole	www.wago.com/232-137/005-000
	Item no.: 232-137/005-000/039-000 Female connector for rail-mount terminal blocks; straight; Locking lever; Pin spacing 5 mm; 7-pole	www.wago.com/232-137/005-000/039-000
	Item no.: 232-138/005-000 Female connector for rail-mount terminal blocks; straight; Pin spacing 5 mm; 8-pole	www.wago.com/232-138/005-000
	Item no.: 232-138/005-000/039-000 Female connector for rail-mount terminal blocks; straight; Locking lever; Pin spacing 5 mm; 8-pole	www.wago.com/232-138/005-000/039-000
	Item no.: 232-139/005-000 Female connector for rail-mount terminal blocks; straight; Pin spacing 5 mm; 9-pole	www.wago.com/232-139/005-000
	Item no.: 232-139/005-000/039-000 Female connector for rail-mount terminal blocks; straight; Locking lever; Pin spacing 5 mm; 9-pole	www.wago.com/232-139/005-000/039-000
	Item no.: 232-140/005-000 Female connector for rail-mount terminal blocks; straight; Pin spacing 5 mm; 10-pole	www.wago.com/232-140/005-000



Item no.: 232-140/005-000/039-000

Female connector for rail-mount terminal blocks; straight; Locking lever; Pin spacing 5 mm; 10-pole

www.wago.com/232-140/005-000/039-000

Item no.: 232-142/005-000

Female connector for rail-mount terminal blocks; straight; Pin spacing 5 mm; 12-pole

www.wago.com/232-142/005-000

Item no.: 232-142/005-000/039-000

Female connector for rail-mount terminal blocks; straight; Locking lever; Pin spacing 5 mm; 12-pole

www.wago.com/232-142/005-000/039-000

Item no.: 232-146/005-000

Female connector for rail-mount terminal blocks; straight; Pin spacing 5 mm; 16-pole

www.wago.com/232-146/005-000

Item no.: 232-146/005-000/039-000

Female connector for rail-mount terminal blocks; straight; Locking lever; Pin spacing 5 mm; 16-pole

www.wago.com/232-146/005-000/039-000

Item no.: 232-147/005-000/039-000

Female connector for rail-mount terminal blocks; straight; Locking lever; Pin spacing 5 mm; 17-pole

www.wago.com/232-147/005-000/039-000

Item no.: 232-150/005-000

Female connector for rail-mount terminal blocks; straight; Pin spacing 5 mm; 20-pole

www.wago.com/232-150/005-000

Item no.: 232-150/005-000/039-000

Female connector for rail-mount terminal blocks; straight; Locking lever; Pin spacing 5 mm; 20-pole

www.wago.com/232-150/005-000/039-000

Item no.: 232-232/005-000

Female connector for rail-mount terminal blocks; angled; Pin spacing 5 mm; 2-pole

www.wago.com/232-232/005-000

Item no.: 232-232/005-000/039-000

Female connector for rail-mount terminal blocks; angled; Locking lever; Pin spacing 5 mm; 2-pole

www.wago.com/232-232/005-000/039-000

Item no.: 232-233/005-000

Female connector for rail-mount terminal blocks; angled; Pin spacing 5 mm; 3-pole

www.wago.com/232-233/005-000

Item no.: 232-233/005-000/039-000

Female connector for rail-mount terminal blocks; angled; Locking lever; Pin spacing 5 mm; 3-pole

www.wago.com/232-233/005-000/039-000

Item no.: 232-234/005-000















Female connector for rail-mount terminal blocks; angled; Pin spacing 5 mm; 4-pole











www.wago.com/232-234/005-000













Item no.: 232-234/005-000/039-000















Female connector for rail-mount terminal blocks; angled; Locking lever; Pin spacing 5 mm; 4-pole















www.wago.com/232-234/005-000/039-000















	Item no.: 232-235/005-000 Female connector for rail-mount terminal blocks; angled; Pin spacing 5 mm; 5-pole	www.wago.com/232-235/005-000
	Item no.: 232-235/005-000/039-000 Female connector for rail-mount terminal blocks; angled; Locking lever; Pin spacing 5 mm; 5-pole	www.wago.com/232-235/005-000/039-000
	Item no.: 232-236/005-000 Female connector for rail-mount terminal blocks; angled; Pin spacing 5 mm; 6-pole	www.wago.com/232-236/005-000
	Item no.: 232-236/005-000/039-000 Female connector for rail-mount terminal blocks; angled; Locking lever; Pin spacing 5 mm; 6-pole	www.wago.com/232-236/005-000/039-000
	Item no.: 232-237/005-000 Female connector for rail-mount terminal blocks; angled; Pin spacing 5 mm; 7-pole	www.wago.com/232-237/005-000
	Item no.: 232-238/005-000 Female connector for rail-mount terminal blocks; angled; Pin spacing 5 mm; 8-pole	www.wago.com/232-238/005-000
	Item no.: 232-239/005-000 Female connector for rail-mount terminal blocks; angled; Pin spacing 5 mm; 9-pole	www.wago.com/232-239/005-000
	Item no.: 232-240/005-000 Female connector for rail-mount terminal blocks; angled; Pin spacing 5 mm; 10-pole	www.wago.com/232-240/005-000
	Item no.: 232-240/005-000/039-000 Female connector for rail-mount terminal blocks; angled; Locking lever; Pin spacing 5 mm; 10-pole	www.wago.com/232-240/005-000/039-000
	Item no.: 232-242/005-000 Female connector for rail-mount terminal blocks; angled; Pin spacing 5 mm; 12-pole	www.wago.com/232-242/005-000
	Item no.: 232-242/005-000/039-000 Female connector for rail-mount terminal blocks; angled; Locking lever; Pin spacing 5 mm; 12-pole	www.wago.com/232-242/005-000/039-000
	Item no.: 232-246/005-000 Female connector for rail-mount terminal blocks; angled; Pin spacing 5 mm; 16-pole	www.wago.com/232-246/005-000
	Item no.: 232-246/005-000/039-000 Female connector for rail-mount terminal blocks; angled; Locking lever; Pin spacing 5 mm; 16-pole	www.wago.com/232-246/005-000/039-000
	Item no.: 232-250/005-000 Female connector for rail-mount terminal blocks; angled; Pin spacing 5 mm; 20-pole	www.wago.com/232-250/005-000
	Item no.: 232-250/005-000/039-000 Female connector for rail-mount terminal blocks; angled; Locking lever; Pin spacing 5 mm; 20-pole	www.wago.com/232-250/005-000/039-000

	Item no.: 232-732/005-000 Female connector for rail-mount terminal blocks; straight; Pin spacing 7.5 mm; 2-pole	www.wago.com/232-732/005-000
	Item no.: 232-733/005-000 Female connector for rail-mount terminal blocks; straight; Pin spacing 7.5 mm; 3-pole	www.wago.com/232-733/005-000
	Item no.: 232-734/005-000 Female connector for rail-mount terminal blocks; straight; Pin spacing 7.5 mm; 4-pole	www.wago.com/232-734/005-000
	Item no.: 232-734/005-000/039-000 Female connector for rail-mount terminal blocks; straight; Pin spacing 7.5 mm; 4-pole	www.wago.com/232-734/005-000/039-000
	Item no.: 232-735/005-000 Female connector for rail-mount terminal blocks; straight; Pin spacing 7.5 mm; 5-pole	www.wago.com/232-735/005-000
	Item no.: 232-735/005-000/039-000 Female connector for rail-mount terminal blocks; straight; Pin spacing 7.5 mm; 5-pole	www.wago.com/232-735/005-000/039-000
	Item no.: 232-736/005-000 Female connector for rail-mount terminal blocks; straight; Pin spacing 7.5 mm; 6-pole	www.wago.com/232-736/005-000
	Item no.: 232-736/005-000/039-000 Female connector for rail-mount terminal blocks; straight; Pin spacing 7.5 mm; 6-pole	www.wago.com/232-736/005-000/039-000
	Item no.: 232-738/005-000 Female connector for rail-mount terminal blocks; straight; Pin spacing 7.5 mm; 8-pole	www.wago.com/232-738/005-000
	Item no.: 232-740/005-000 Female connector for rail-mount terminal blocks; straight; Pin spacing 7.5 mm; 10-pole	www.wago.com/232-740/005-000
	Item no.: 232-742/005-000 Female connector for rail-mount terminal blocks; straight; Pin spacing 7.5 mm; 12-pole	www.wago.com/232-742/005-000
	Item no.: 232-832/005-000 Female connector for rail-mount terminal blocks; angled; Pin spacing 7.5 mm; 2-pole	www.wago.com/232-832/005-000
	Item no.: 232-833/005-000 Female connector for rail-mount terminal blocks; angled; Pin spacing 7.5 mm; 3-pole	www.wago.com/232-833/005-000
	Item no.: 232-834/005-000 Female connector for rail-mount terminal blocks; angled; Pin spacing 7.5 mm; 4-pole	www.wago.com/232-834/005-000

	Item no.: 232-836/005-000 Female connector for rail-mount terminal blocks; angled; Pin spacing 7.5 mm; 6-pole	www.wago.com/232-836/005-000
	Item no.: 232-836/005-000/039-000 Female connector for rail-mount terminal blocks; angled; Pin spacing 7.5 mm; 6-pole	www.wago.com/232-836/005-000/039-000
	Item no.: 232-840/005-000 Female connector for rail-mount terminal blocks; angled; Pin spacing 7.5 mm; 10-pole	www.wago.com/232-840/005-000
	Item no.: 232-842/005-000 Female connector for rail-mount terminal blocks; angled; Pin spacing 7.5 mm; 12-pole	www.wago.com/232-842/005-000
	Item no.: 722-132/005-000 Female connector for rail-mount terminal blocks; straight; 100% protected against mismatching; Pin spacing 5 mm; 2-pole	www.wago.com/722-132/005-000
	Item no.: 722-132/005-000/039-000 Female connector for rail-mount terminal blocks; straight; 100% protected against mismatching; Locking lever; Pin spacing 5 mm; 3-pole	www.wago.com/722-132/005-000/039-000
	Item no.: 722-133/005-000 Female connector for rail-mount terminal blocks; straight; 100% protected against mismatching; Pin spacing 5 mm; 3-pole	www.wago.com/722-133/005-000
	Item no.: 722-133/005-000/039-000 Female connector for rail-mount terminal blocks; straight; 100% protected against mismatching; Locking lever; Pin spacing 5 mm; 3-pole	www.wago.com/722-133/005-000/039-000
	Item no.: 722-134/005-000 Female connector for rail-mount terminal blocks; straight; 100% protected against mismatching; Pin spacing 5 mm; 4-pole	www.wago.com/722-134/005-000
	Item no.: 722-134/005-000/039-000 Female connector for rail-mount terminal blocks; straight; 100% protected against mismatching; Locking lever; Pin spacing 5 mm; 4-pole	www.wago.com/722-134/005-000/039-000
	Item no.: 722-135/005-000 Female connector for rail-mount terminal blocks; straight; 100% protected against mismatching; Pin spacing 5 mm; 5-pole	www.wago.com/722-135/005-000
	Item no.: 722-135/005-000/039-000 Female connector for rail-mount terminal blocks; straight; 100% protected against mismatching; Locking lever; Pin spacing 5 mm; 5-pole	www.wago.com/722-135/005-000/039-000
	Item no.: 722-136/005-000 Female connector for rail-mount terminal blocks; straight; 100% protected against mismatching; Pin spacing 5 mm; 6-pole	www.wago.com/722-136/005-000
	Item no.: 722-136/005-000/039-000 Female connector for rail-mount terminal blocks; straight; 100% protected against mismatching; Locking lever; Pin spacing 5 mm; 6-pole	www.wago.com/722-136/005-000/039-000
	Item no.: 722-137/005-000 Female connector for rail-mount terminal blocks; straight; 100% protected against mismatching; Pin	

	spacing 5 mm; 7-pole	www.wago.com/722-137/005-000
	Item no.: 722-137/005-000/039-000 Female connector for rail-mount terminal blocks; straight; 100% protected against mismatching; Locking lever; Pin spacing 5 mm; 7-pole	www.wago.com/722-137/005-000/039-000
	Item no.: 722-138/005-000 Female connector for rail-mount terminal blocks; straight; 100% protected against mismatching; Pin spacing 5 mm; 8-pole	www.wago.com/722-138/005-000
	Item no.: 722-138/005-000/039-000 Female connector for rail-mount terminal blocks; straight; 100% protected against mismatching; Locking lever; Pin spacing 5 mm; 8-pole	www.wago.com/722-138/005-000/039-000
	Item no.: 722-139/005-000 Female connector for rail-mount terminal blocks; straight; 100% protected against mismatching; Pin spacing 5 mm; 9-pole	www.wago.com/722-139/005-000
	Item no.: 722-139/005-000/039-000 Female connector for rail-mount terminal blocks; straight; 100% protected against mismatching; Locking lever; Pin spacing 5 mm; 9-pole	www.wago.com/722-139/005-000/039-000
	Item no.: 722-140/005-000 Female connector for rail-mount terminal blocks; straight; 100% protected against mismatching; Pin spacing 5 mm; 10-pole	www.wago.com/722-140/005-000
	Item no.: 722-140/005-000/039-000 Female connector for rail-mount terminal blocks; straight; 100% protected against mismatching; Locking lever; Pin spacing 5 mm; 10-pole	www.wago.com/722-140/005-000/039-000
	Item no.: 722-141/005-000 Female connector for rail-mount terminal blocks; straight; 100% protected against mismatching; Pin spacing 5 mm; 11-pole	www.wago.com/722-141/005-000
	Item no.: 722-142/005-000 Female connector for rail-mount terminal blocks; straight; 100% protected against mismatching; Pin spacing 5 mm; 12-pole	www.wago.com/722-142/005-000
	Item no.: 722-142/005-007/039-000 Female connector for rail-mount terminal blocks; straight; 100% protected against mismatching; Locking lever; Pin spacing 5 mm; 12-pole	www.wago.com/722-142/005-007/039-000
	Item no.: 722-143/005-000 Female connector for rail-mount terminal blocks; straight; 100% protected against mismatching; Pin spacing 5 mm; 13-pole	www.wago.com/722-143/005-000
	Item no.: 722-144/005-000 Female connector for rail-mount terminal blocks; straight; 100% protected against mismatching; Pin spacing 5 mm; 14-pole	www.wago.com/722-144/005-000
	Item no.: 722-144/005-000/039-000 Female connector for rail-mount terminal blocks; straight; 100% protected against mismatching; Locking lever; Pin spacing 5 mm; 14-pole	www.wago.com/722-144/005-000/039-000
	Item no.: 722-145/005-000 Female connector for rail-mount terminal blocks; straight; 100% protected against mismatching; Pin	

	spacing 5 mm; 15-pole	www.wago.com/722-145/005-000
	Item no.: 722-146/005-000 Female connector for rail-mount terminal blocks; straight; 100% protected against mismatching; Pin spacing 5 mm; 16-pole	www.wago.com/722-146/005-000
	Item no.: 722-146/005-000/039-000 Female connector for rail-mount terminal blocks; straight; 100% protected against mismatching; Locking lever; Pin spacing 5 mm; 16-pole	www.wago.com/722-146/005-000/039-000
	Item no.: 722-150/005-000 Female connector for rail-mount terminal blocks; straight; 100% protected against mismatching; Pin spacing 5 mm; 20-pole	www.wago.com/722-150/005-000
	Item no.: 722-150/005-000/039-000 Female connector for rail-mount terminal blocks; straight; 100% protected against mismatching; Locking lever; Pin spacing 5 mm; 20-pole	www.wago.com/722-150/005-000/039-000
	Item no.: 722-232/005-000 Female connector for rail-mount terminal blocks; angled; 100% protected against mismatching; Pin spacing 5 mm; 3-pole	www.wago.com/722-232/005-000
	Item no.: 722-232/005-000/039-000 Female connector for rail-mount terminal blocks; angled; 100% protected against mismatching; Locking lever; Pin spacing 5 mm; 3-pole	www.wago.com/722-232/005-000/039-000
	Item no.: 722-233/005-000 Female connector for rail-mount terminal blocks; angled; 100% protected against mismatching; Pin spacing 5 mm; 3-pole	www.wago.com/722-233/005-000
	Item no.: 722-233/005-000/039-000 Female connector for rail-mount terminal blocks; angled; 100% protected against mismatching; Locking lever; Pin spacing 5 mm; 3-pole	www.wago.com/722-233/005-000/039-000
	Item no.: 722-234/005-000 Female connector for rail-mount terminal blocks; angled; 100% protected against mismatching; Pin spacing 5 mm; 4-pole	www.wago.com/722-234/005-000
	Item no.: 722-234/005-000/039-000 Female connector for rail-mount terminal blocks; angled; 100% protected against mismatching; Locking lever; Pin spacing 5 mm; 4-pole	www.wago.com/722-234/005-000/039-000
	Item no.: 722-235/005-000 Female connector for rail-mount terminal blocks; angled; 100% protected against mismatching; Pin spacing 5 mm; 5-pole	www.wago.com/722-235/005-000
	Item no.: 722-235/005-000/039-000 Female connector for rail-mount terminal blocks; angled; 100% protected against mismatching; Locking lever; Pin spacing 5 mm; 5-pole	www.wago.com/722-235/005-000/039-000
	Item no.: 722-236/005-000 Female connector for rail-mount terminal blocks; angled; 100% protected against mismatching; Pin spacing 5 mm; 6-pole	www.wago.com/722-236/005-000
	Item no.: 722-236/005-000/039-000 Female connector for rail-mount terminal blocks; angled; 100% protected against mismatching;	

	Locking lever; Pin spacing 5 mm; 6-pole	www.wago.com/722-236/005-000/039-000
	Item no.: 722-237/005-000 Female connector for rail-mount terminal blocks; angled; 100% protected against mismating; Pin spacing 5 mm; 7-pole	www.wago.com/722-237/005-000
	Item no.: 722-237/005-000/039-000 Female connector for rail-mount terminal blocks; angled; 100% protected against mismating; Locking lever; Pin spacing 5 mm; 7-pole	www.wago.com/722-237/005-000/039-000
	Item no.: 722-238/005-000 Female connector for rail-mount terminal blocks; angled; 100% protected against mismating; Pin spacing 5 mm; 8-pole	www.wago.com/722-238/005-000
	Item no.: 722-239/005-000 Female connector for rail-mount terminal blocks; angled; 100% protected against mismating; Pin spacing 5 mm; 9-pole	www.wago.com/722-239/005-000
	Item no.: 722-239/005-000/039-000 Female connector for rail-mount terminal blocks; angled; 100% protected against mismating; Locking lever; Pin spacing 5 mm; 9-pole	www.wago.com/722-239/005-000/039-000
	Item no.: 722-240/005-000 Female connector for rail-mount terminal blocks; angled; 100% protected against mismating; Pin spacing 5 mm; 10-pole	www.wago.com/722-240/005-000
	Item no.: 722-240/005-000/039-000 Female connector for rail-mount terminal blocks; angled; 100% protected against mismating; Locking lever; Pin spacing 5 mm; 10-pole	www.wago.com/722-240/005-000/039-000
	Item no.: 722-241/005-000 Female connector for rail-mount terminal blocks; angled; 100% protected against mismating; Pin spacing 5 mm; 11-pole	www.wago.com/722-241/005-000
	Item no.: 722-242/005-000 Female connector for rail-mount terminal blocks; angled; 100% protected against mismating; Pin spacing 5 mm; 12-pole	www.wago.com/722-242/005-000
	Item no.: 722-242/005-000/039-000 Female connector for rail-mount terminal blocks; angled; 100% protected against mismating; Locking lever; Pin spacing 5 mm; 12-pole	www.wago.com/722-242/005-000/039-000
	Item no.: 722-243/005-000 Female connector for rail-mount terminal blocks; angled; 100% protected against mismating; Pin spacing 5 mm; 13-pole	www.wago.com/722-243/005-000
	Item no.: 722-244/005-000 Female connector for rail-mount terminal blocks; angled; 100% protected against mismating; Pin spacing 5 mm; 14-pole	www.wago.com/722-244/005-000
	Item no.: 722-244/005-000/039-000 Female connector for rail-mount terminal blocks; angled; 100% protected against mismating; Locking lever; Pin spacing 5 mm; 14-pole	www.wago.com/722-244/005-000/039-000
	Item no.: 722-246/005-000 Female connector for rail-mount terminal blocks; angled; 100% protected against mismating; Pin	



spacing 5 mm; 16-pole

www.wago.com/722-246/005-000



Item no.: 722-246/005-000/039-000

Female connector for rail-mount terminal blocks; angled; 100% protected against mismating; Locking lever; Pin spacing 5 mm; 16-pole

www.wago.com/722-246/005-000/039-000



Item no.: 722-250/005-000

Female connector for rail-mount terminal blocks; angled; 100% protected against mismating; Pin spacing 5 mm; 20-pole

www.wago.com/722-250/005-000

Carrier rail



Item no.: 210-112

Steel carrier rail; 35 x 7.5 mm; 1 mm thick; 2 m long; slotted; according to EN 60715; "Hole width 25 mm

www.wago.com/210-112



Item no.: 210-113

Steel carrier rail; 35 x 7.5 mm; 1 mm thick; 2 m long; unslotted; according to EN 60715

www.wago.com/210-113



Item no.: 210-114

Steel carrier rail; 35 x 15 mm; 1.5 mm thick; 2 m long; unslotted; similar to EN 60715

www.wago.com/210-114



Item no.: 210-115

Steel carrier rail; 35 x 7.5 mm; 1 mm thick; 2 m long; slotted; according to EN 60715; "Hole width 18 mm

www.wago.com/210-115



Item no.: 210-118

Steel carrier rail; 35 x 15 mm; 2.3 mm thick; 2 m long; unslotted; according to EN 60715

www.wago.com/210-118



Item no.: 210-196

Aluminum carrier rail; 35 x 8.2 mm; 1.6 mm thick; 2 m long; unslotted; similar to EN 60715

www.wago.com/210-196



Item no.: 210-197

Steel carrier rail; 35 x 15 mm; 1.5 mm thick; 2 m long; slotted; similar to EN 60715

www.wago.com/210-197



Item no.: 210-198

Copper carrier rail; 35 x 15 mm; 2.3 mm thick; 2 m long; unslotted; according to EN 60715

www.wago.com/210-198



Item no.: 210-504

Steel carrier rail; 35 x 7.5 mm; 1 mm thick; 2 m long; slotted; galvanized; according to EN 60715

www.wago.com/210-504



Item no.: 210-505

Steel carrier rail; 35 x 7.5 mm; 1 mm thick; 2 m long; unslotted; galvanized; according to EN 60715

www.wago.com/210-505



Item no.: 210-506

Steel carrier rail; 35 x 15 mm; 1.5 mm thick; 2 m long; unslotted; galvanized; similar to EN 60715

www.wago.com/210-506



Item no.: 210-508

Steel carrier rail; 35 x 15 mm; 1.5 mm thick; 2 m long; slotted; galvanized; similar to EN 60715

www.wago.com/210-508

Protective Warning Marker











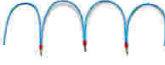

















Item no.: 280-415

Protective warning marker; with high-voltage symbol, black; for 5 terminal blocks

www.wago.com/280-415

Jumper

	Item no.: 210-103 Wire commoning chain; insulated; 50 connections	www.wago.com/210-103
	Item no.: 210-123 Wire commoning chain; insulated; 50 connections	www.wago.com/210-123
	Item no.: 280-482 Comb-style jumper bar; insulated; 2-way; IN = IN terminal block	www.wago.com/280-482
	Item no.: 280-483 Comb-style jumper bar; insulated; 3-way; IN = IN terminal block	www.wago.com/280-483
	Item no.: 280-484 Comb-style jumper bar; insulated; 4-way; IN = IN terminal block	www.wago.com/280-484
	Item no.: 280-485 Comb-style jumper bar; insulated; 5-way; IN = IN terminal block	www.wago.com/280-485
	Item no.: 280-490 Comb-style jumper bar; insulated; 10-way; IN = IN terminal block	www.wago.com/280-490
	Item no.: 280-492 Alternate comb-style jumper bar; insulated; 2-way; IN = IN terminal block	www.wago.com/280-492
	Item no.: 709-110 Wire commoning chain; insulated; 4 connections; 3 x 110 mm	www.wago.com/709-110
	Item no.: 709-111 Wire commoning chain; insulated; 3 connections; 2 x 120 mm	www.wago.com/709-111
	Item no.: 709-112 Wire commoning chain; insulated; 3 connections; 2 x 170 mm	www.wago.com/709-112
check		
	Item no.: 210-136 Test plug; 2 mm Ø; with 500 mm cable	www.wago.com/210-136
	Item no.: 210-137 Test plug; 2.3 mm Ø; with 500 mm cable	www.wago.com/210-137
	Item no.: 249-141 L-type test plug module; modular; with spring-loaded contact pin; Center module	www.wago.com/249-141
Insulation stop		
	Item no.: 280-470 Insulation stop; 0.08 - 0.2 mm ² "s" (0.14 mm ² "f-st"); 5 pieces/strip	www.wago.com/280-470
	Item no.: 280-471 Insulation stop; 0.25 - 0.5 mm ² ; 5 pieces/strip	www.wago.com/280-471
	Item no.: 280-472 Insulation stop; 0.75 - 1 mm ² ; 5 pieces/strip	www.wago.com/280-472
ferrule		
	Item no.: 216-101 Ferrule; Sleeve for 0.5 mm ² / AWG 22; uninsulated; electro-tin plated	www.wago.com/216-101

		
	Item no.: 216-102 Ferrule; Sleeve for 0.75 mm ² / AWG 20; uninsulated; electro-tin plated	www.wago.com/216-102
	Item no.: 216-103 Ferrule; Sleeve for 1 mm ² / AWG 18; uninsulated; electro-tin plated	www.wago.com/216-103
	Item no.: 216-104 Ferrule; Sleeve for 1.5 mm ² / AWG 16; uninsulated; electro-tin plated	www.wago.com/216-104
	Item no.: 216-201 Ferrule; Sleeve for 0.5 mm ² / AWG 22; insulated; electro-tin plated	www.wago.com/216-201
	Item no.: 216-202 Ferrule; Sleeve for 0.75 mm ² / AWG 20; insulated; electro-tin plated	www.wago.com/216-202
	Item no.: 216-203 Ferrule; Sleeve for 1 mm ² / AWG 18; insulated; electro-tin plated	www.wago.com/216-203
	Item no.: 216-204 Ferrule; Sleeve for 1.5 mm ² / AWG 16; insulated; electro-tin plated	www.wago.com/216-204
	Item no.: 216-301 Ferrule; Sleeve for 0.25 mm ² / AWG 24; insulated; electro-tin plated	www.wago.com/216-301
	Item no.: 216-302 Ferrule; Sleeve for 0.34 mm ² / AWG 24; insulated; electro-tin plated	www.wago.com/216-302

Downloads

smartDATA

CAD data

	URL	Download
3D Download 280-649		

Subject to changes.