

Data sheet | Item number: 280-803

Empty component plug housing; 10 mm wide; Type 4; 2-pole

www.wago.com/280-803

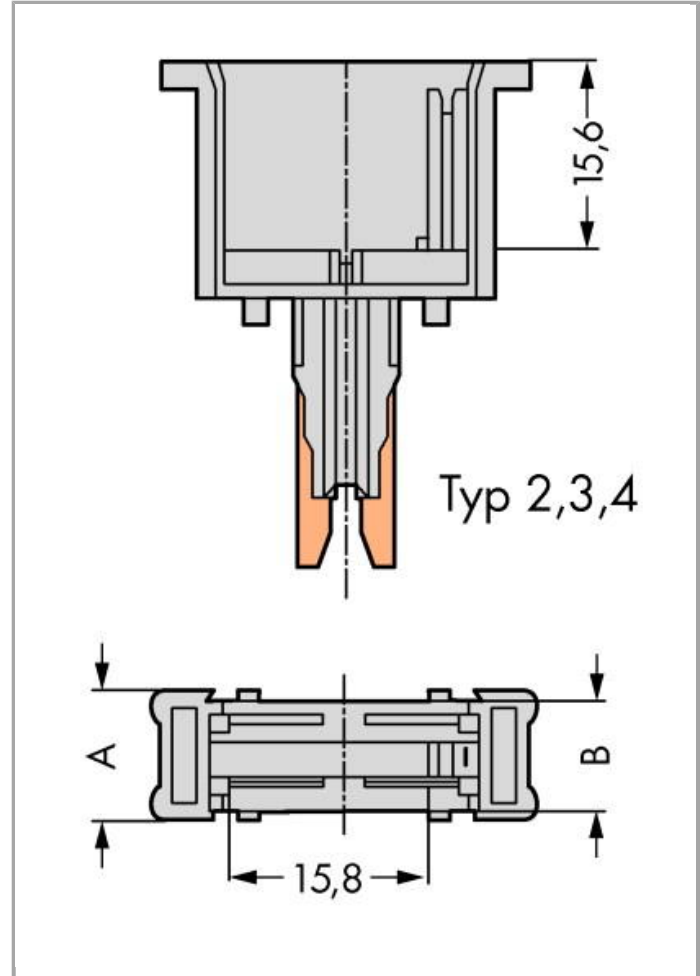
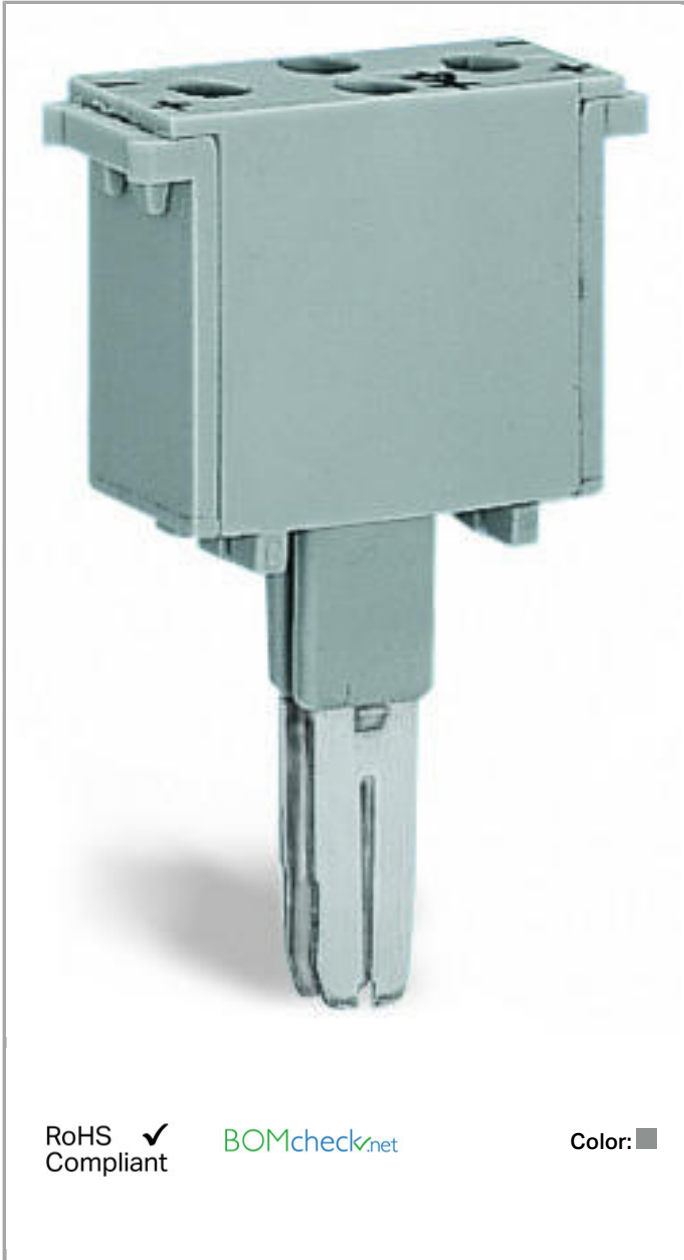

Typ	1	2	3	4
A	5	10	10	10
B	3,2	8,2	8,2	8,2

Item description

Empty component plug housing, type 4

Note:

Inside dimensions of plug W/H/D 8.2/15/15 mm (0.323/0.591/0.591 in)

Data

Electrical data

Rated continuous current 6 A

Safety and protection:

Rated voltage 250 V

Rated impulse voltage 4 kV

Pollution degree 3

Connection data

No. of poles 2

Type of wiring Front-entry wiring

Geometrical Data

Width 10 mm / 0.394 inch

Mechanical data

Housing design Pluggable module for terminal blocks

Type of mounting Pluggable module for carrier terminal blocks

Material Data

Color gray









Fire load	0.072 MJ
Weight	3.919 g

Commercial data

Country of origin	DE
GTIN	4044918270397
Customs Tariff No.	85366990990
Product Group	1 (Rail Mounted Terminal Blocks)

Compatible products

clamps

	Item no.: 280-101 2-conductor through terminal block; 2.5 mm ² ; lateral marker slots; for DIN-rail 35 x 15 and 35 x 7.5; CAGE CLAMP®	www.wago.com/280-101
	Item no.: 280-601 2-conductor through terminal block; 2.5 mm ² ; lateral marker slots; for DIN-rail 35 x 15 and 35 x 7.5; CAGE CLAMP®	www.wago.com/280-601
	Item no.: 280-603 4-conductor through terminal block; 2.5 mm ² ; center marking; for DIN-rail 35 x 15 and 35 x 7.5; CAGE CLAMP®	www.wago.com/280-603
	Item no.: 280-621 4-conductor through terminal block; 2.5 mm ² ; lateral marker slots; for DIN-rail 35 x 15 and 35 x 7.5; CAGE CLAMP®	www.wago.com/280-621
	Item no.: 280-633 4-conductor through terminal block; 2.5 mm ² ; center marking; for DIN-rail 35 x 15 and 35 x 7.5; CAGE CLAMP®	www.wago.com/280-633
	Item no.: 280-681 3-conductor through terminal block; 2.5 mm ² ; center marking; for DIN-rail 35 x 15 and 35 x 7.5; CAGE CLAMP®	www.wago.com/280-681
	Item no.: 280-833 4-conductor through terminal block; 2.5 mm ² ; center marking; for DIN-rail 35 x 15 and 35 x 7.5; CAGE CLAMP®	www.wago.com/280-833
	Item no.: 280-901 2-conductor through terminal block; 2.5 mm ² ; center marking; for DIN-rail 35 x 15 and 35 x 7.5; CAGE CLAMP®	www.wago.com/280-901

Downloads

Documentation

Additional Information

Disposal; Electrical and electronic equipment, Packaging

Oct 15, 2018

Download

265.8 kB



smartDATA

CAD data

3D Download 280-803

URL

Download

Subject to changes.

WAGO Kontakttechnik GmbH & Co. KG

Hansastr. 27

32423 Minden

Phone: +49571 887-0 | Fax: +49571 887-169

Email: info.de@wago.com | Web: www.wago.com

Do you have any questions about our products?

We are always happy to take your call at +49 (571) 887-44222.