

Data sheet | Item number: 281-691

2-conductor through terminal block; 4 mm²; suitable for Ex e II applications;
lateral marker slots; for DIN-rail 35 x 15 and 35 x 7.5; CAGE CLAMP®

www.wago.com/281-691

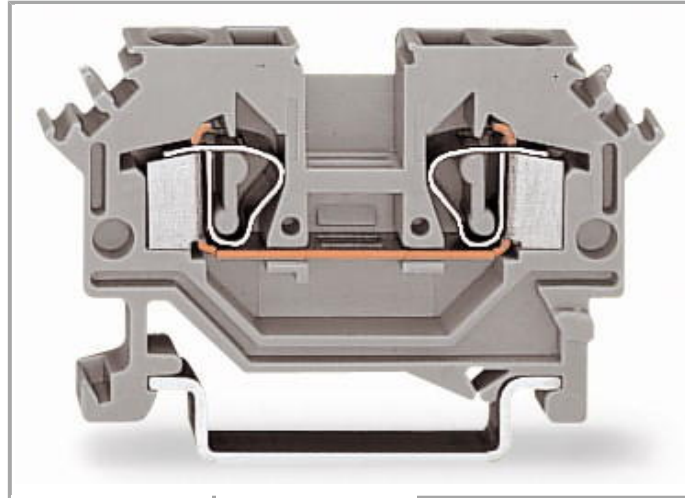

RoHS Compliant

BOMcheck.net

Color: ■

Data

Electrical data

Rated voltage EN (Ex e II)	550 V
----------------------------	-------

Ratings per IEC/EN 60664-1

Rated current	30 A
---------------	------

Connection data

Connection technology	CAGE CLAMP®
Actuation type	Operating tool
Connectable conductor materials	Copper Aluminum
Solid conductor	0.08 ... 4 mm ² / 28 ... 12 AWG
Fine-stranded conductor	0.08 ... 4 mm ² / 28 ... 12 AWG
Strip length	9 ... 10 mm / 0.35 ... 0.39 Inch
Total number of connection points	2
Total number of potentials	1
Number of levels	1
Type of wiring	Front-entry wiring

Geometrical Data

Width	6 mm / 0.236 inch
Height from upper-edge of DIN-35 rail	29 mm / 1.142 inch
Depth	53 mm / 2.087 inch

Mechanical data

Design	horizontal
Type of mounting	DIN-35 rail
Marking level	Side marking

Material Data



Color	light gray
Insulating material	Polyamide 66 (PA 66)
Fire load	0.128 MJ
Weight	6.9 g

Commercial data

Country of origin	DE
GTIN	4044918500746
Customs Tariff No.	85369010000

Approvals / Certificates

Country specific Approvals

Logo	Approval	Certificate name
	CCA DEKRA Certification B.V.	NTR NL-7454/A1
	CCA DEKRA Certification B.V.	NTR NL-7454/A1
	CSA DEKRA Certification B.V.	1505034

Ship Approvals

Logo	Approval	Certificate name
	ABS American Bureau of Shipping	14-HG1293677-PDA



BV
Bureau Veritas S.A.

07436/E0 BV



LR
Lloyds Register

91/20112 (E9)

UL-Approvals

Logo

Approval

Certificate name



UR
Underwriters Laboratories Inc.

E45172

Compatible products

End plate



Item no.: 209-190
Separator for Ex e/Ex i applications; 3 mm thick; 90 mm wide

www.wago.com/209-190

Item no.: 209-191
Separator for Ex e/Ex i applications; 3 mm thick; 120 mm wide

www.wago.com/209-191

Item no.: 209-192
Separator for Ex e/Ex i applications; 3 mm thick; 125.5 mm wide

www.wago.com/209-192

Item no.: 281-353
End and intermediate plate; 3 mm thick

www.wago.com/281-353

Item no.: 281-354
Separator plate; 2 mm thick; oversized

www.wago.com/281-354

General accessories



Item no.: 249-105
Group marker carrier

www.wago.com/249-105

Jumper



Item no.: 249-123
Push-in type wire jumper; insulated; wire length 180 mm; Conductor cross section 0.75 mm²

www.wago.com/249-123

Item no.: 249-125
Push-in type wire jumper; insulated; wire length 60 mm; Conductor cross section 0.75 mm²









www.wago.com/249-125

Item no.: 249-126
Push-in type wire jumper; insulated; wire length 110 mm; Conductor cross section 0.75 mm²















www.wago.com/249-126

Item no.: 249-127
Push-in type wire jumper; insulated; wire length 250 mm; Conductor cross section 0.75 mm²



www.wago.com/249-127

	Item no.: 281-402 Adjacent jumper; insulated; IN = IN terminal block	www.wago.com/281-402
	Item no.: 281-409 Alternate jumper; insulated; IN = IN terminal block	www.wago.com/281-409
	Item no.: 281-422 Adjacent jumper; insulated; IN = IN terminal block	www.wago.com/281-422
	Item no.: 281-482 Comb-style jumper bar; insulated; 2-way; IN = IN terminal block	www.wago.com/281-482
	Item no.: 281-483 Comb-style jumper bar; insulated; 3-way; IN = IN terminal block	www.wago.com/281-483
	Item no.: 281-485 Comb-style jumper bar; insulated; 5-way; IN = IN terminal block	www.wago.com/281-485
	Item no.: 281-490 Comb-style jumper bar; insulated; 10-way; IN = IN terminal block	www.wago.com/281-490
	Item no.: 281-492 Alternate comb-style jumper bar; insulated; 2-way; IN = IN terminal block	www.wago.com/281-492
	Item no.: 709-110 Wire commoning chain; insulated; 4 connections; 3 x 110 mm	www.wago.com/709-110
	Item no.: 709-111 Wire commoning chain; insulated; 3 connections; 2 x 120 mm	www.wago.com/709-111
	Item no.: 709-112 Wire commoning chain; insulated; 3 connections; 2 x 170 mm	www.wago.com/709-112
	Item no.: 781-452 Staggered jumper; insulated; from 1 to 2; Spacing: 6 mm	www.wago.com/781-452
	Item no.: 781-453 Staggered jumper; insulated; from 1 to 3; Spacing: 6 mm	www.wago.com/781-453
	Item no.: 781-454 Staggered jumper; insulated; from 1 to 4; Spacing: 6 mm	www.wago.com/781-454
	Item no.: 781-455 Staggered jumper; insulated; from 1 to 5; Spacing: 6 mm	www.wago.com/781-455
	Item no.: 781-456 Staggered jumper; insulated; from 1 to 6; Spacing: 6 mm	www.wago.com/781-456
tools		
	Item no.: 210-657 Operating tool with partially insulated shaft; Blade (3.5 x 0.5) mm; short	www.wago.com/210-657
	Item no.: 210-658 Operating tool with partially insulated shaft; Blade (3.5 x 0.5) mm; short; angled	www.wago.com/210-658
	Item no.: 210-720 Operating tool with partially insulated shaft; Type 2, blade (3.5 x 0.5) mm	www.wago.com/210-720













ferrule

	Item no.: 216-106 Ferrule; Sleeve for 2.5 mm ² / AWG 14; uninsulated; electro-tin plated	www.wago.com/216-106
	Item no.: 216-201 Ferrule; Sleeve for 0.5 mm ² / AWG 22; insulated; electro-tin plated	www.wago.com/216-201
	Item no.: 216-202 Ferrule; Sleeve for 0.75 mm ² / AWG 20; insulated; electro-tin plated	www.wago.com/216-202
	Item no.: 216-203 Ferrule; Sleeve for 1 mm ² / AWG 18; insulated; electro-tin plated	www.wago.com/216-203
	Item no.: 216-204 Ferrule; Sleeve for 1.5 mm ² / AWG 16; insulated; electro-tin plated	www.wago.com/216-204
	Item no.: 216-205 Ferrule; Sleeve for 2.08 mm ² / AWG 14; insulated; electro-tin plated	www.wago.com/216-205
	Item no.: 216-206 Ferrule; Sleeve for 2.5 mm ² / AWG 14; insulated; electro-tin plated	www.wago.com/216-206
	Item no.: 216-241 Ferrule; Sleeve for 0.5 mm ² / AWG 22; insulated; electro-tin plated; electrolytic copper; gastight crimped; acc. to DIN 46228, Part 4/09.90	www.wago.com/216-241
	Item no.: 216-242 Ferrule; Sleeve for 0.75 mm ² / AWG 20; insulated; electro-tin plated; electrolytic copper; gastight crimped; acc. to DIN 46228, Part 4/09.90	www.wago.com/216-242
	Item no.: 216-243 Ferrule; Sleeve for 1 mm ² / AWG 18; insulated; electro-tin plated; electrolytic copper; gastight crimped; acc. to DIN 46228, Part 4/09.90	www.wago.com/216-243
	Item no.: 216-244 Ferrule; Sleeve for 1.5 mm ² / AWG 16; insulated; electro-tin plated; electrolytic copper; gastight crimped; acc. to DIN 46228, Part 4/09.90	www.wago.com/216-244
	Item no.: 216-246 Ferrule; Sleeve for 2.5 mm ² / AWG 14; insulated; electro-tin plated; electrolytic copper; gastight crimped; acc. to DIN 46228, Part 4/09.90	www.wago.com/216-246
	Item no.: 216-301 Ferrule; Sleeve for 0.25 mm ² / AWG 24; insulated; electro-tin plated	www.wago.com/216-301
	Item no.: 216-302 Ferrule; Sleeve for 0.34 mm ² / AWG 24; insulated; electro-tin plated	www.wago.com/216-302





Insulation stop

















	Item no.: 281-470 Insulation stop; 0.08 - 0.2 mm ² "s" (0.14 mm ² "f-st"); 5 pieces/strip	www.wago.com/281-470
	Item no.: 281-471 Insulation stop; 0.25 - 0.5 mm ² ; 5 pieces/strip	www.wago.com/281-471
	Item no.: 281-472 Insulation stop; 0.75 - 1.5 mm ² ; 5 pieces/strip	www.wago.com/281-472









Carrier rail

	Item no.: 210-112 Steel carrier rail; 35 x 7.5 mm; 1 mm thick; 2 m long; slotted; according to EN 60715; "Hole width 25 mm	www.wago.com/210-112
	Item no.: 210-113 Steel carrier rail; 35 x 7.5 mm; 1 mm thick; 2 m long; unslotted; according to EN 60715	www.wago.com/210-113
	Item no.: 210-114 Steel carrier rail; 35 x 15 mm; 1.5 mm thick; 2 m long; unslotted; similar to EN 60715	www.wago.com/210-114
	Item no.: 210-115 Steel carrier rail; 35 x 7.5 mm; 1 mm thick; 2 m long; slotted; according to EN 60715; "Hole width 18 mm	www.wago.com/210-115
	Item no.: 210-118 Steel carrier rail; 35 x 15 mm; 2.3 mm thick; 2 m long; unslotted; according to EN 60715	www.wago.com/210-118
	Item no.: 210-196 Aluminum carrier rail; 35 x 8.2 mm; 1.6 mm thick; 2 m long; unslotted; similar to EN 60715	www.wago.com/210-196
	Item no.: 210-197 Steel carrier rail; 35 x 15 mm; 1.5 mm thick; 2 m long; slotted; similar to EN 60715	www.wago.com/210-197
	Item no.: 210-198 Copper carrier rail; 35 x 15 mm; 2.3 mm thick; 2 m long; unslotted; according to EN 60715	www.wago.com/210-198
	Item no.: 210-504 Steel carrier rail; 35 x 7.5 mm; 1 mm thick; 2 m long; slotted; galvanized; according to EN 60715	www.wago.com/210-504
	Item no.: 210-505 Steel carrier rail; 35 x 7.5 mm; 1 mm thick; 2 m long; unslotted; galvanized; according to EN 60715	www.wago.com/210-505
	Item no.: 210-506 Steel carrier rail; 35 x 15 mm; 1.5 mm thick; 2 m long; unslotted; galvanized; similar to EN 60715	www.wago.com/210-506
	Item no.: 210-508 Steel carrier rail; 35 x 15 mm; 1.5 mm thick; 2 m long; slotted; galvanized; similar to EN 60715	www.wago.com/210-508

Marking accessories

	Item no.: 2009-115 WMB-Inline; for smartPRINTER; on reel; stretchable 5 - 5.2 mm; plain; snap-on type	www.wago.com/2009-115
	Item no.: 2009-115/000-002 WMB-Inline; for smartPRINTER; on reel; stretchable 5 - 5.2 mm; plain; snap-on type	www.wago.com/2009-115/000-002
	Item no.: 2009-115/000-006 WMB-Inline; for smartPRINTER; on reel; stretchable 5 - 5.2 mm; plain; snap-on type	www.wago.com/2009-115/000-006
	Item no.: 2009-115/000-007 WMB-Inline; for smartPRINTER; on reel; stretchable 5 - 5.2 mm; plain; snap-on type	www.wago.com/2009-115/000-007
	Item no.: 2009-115/000-012 WMB-Inline; for smartPRINTER; on reel; stretchable 5 - 5.2 mm; plain; snap-on type	www.wago.com/2009-115/000-012



	<p>Item no.: 2009-115/000-017 WMB-Inline; for smartPRINTER; on reel; stretchable 5 - 5.2 mm; plain; snap-on type</p>	www.wago.com/2009-115/000-017
	<p>Item no.: 2009-115/000-023 WMB-Inline; for smartPRINTER; on reel; stretchable 5 - 5.2 mm; plain; snap-on type</p>	www.wago.com/2009-115/000-023
	<p>Item no.: 2009-115/000-024 WMB-Inline; for smartPRINTER; on reel; stretchable 5 - 5.2 mm; plain; snap-on type</p>	www.wago.com/2009-115/000-024
	<p>Item no.: 209-140 Group marker carrier</p>	www.wago.com/209-140
	<p>Item no.: 209-141 Group marker carrier</p>	www.wago.com/209-141
	<p>Item no.: 209-142 Group marker carrier</p>	www.wago.com/209-142
	<p>Item no.: 209-185 Adaptor</p>	www.wago.com/209-185
	<p>Item no.: 793-501 WMB marking card; as card; not stretchable; plain; snap-on type</p>	www.wago.com/793-501
	<p>Item no.: 793-501/000-002 WMB marking card; as card; not stretchable; plain; snap-on type</p>	www.wago.com/793-501/000-002
	<p>Item no.: 793-501/000-005 WMB marking card; as card; not stretchable; plain; snap-on type</p>	www.wago.com/793-501/000-005
	<p>Item no.: 793-501/000-006 WMB marking card; as card; not stretchable; plain; snap-on type</p>	www.wago.com/793-501/000-006
	<p>Item no.: 793-501/000-007 WMB marking card; as card; not stretchable; plain; snap-on type</p>	www.wago.com/793-501/000-007
	<p>Item no.: 793-501/000-012 WMB marking card; as card; not stretchable; plain; snap-on type</p>	www.wago.com/793-501/000-012
	<p>Item no.: 793-501/000-017 WMB marking card; as card; not stretchable; plain; snap-on type</p>	www.wago.com/793-501/000-017
	<p>Item no.: 793-501/000-023 WMB marking card; as card; not stretchable; plain; snap-on type</p>	www.wago.com/793-501/000-023
	<p>Item no.: 793-501/000-024 WMB marking card; as card; not stretchable; plain; snap-on type</p>	www.wago.com/793-501/000-024

	Item no.: 793-5501 WMB marking card; as card; for terminal block width 5 - 17.5 mm; stretchable 5 - 5.2 mm; plain; snap-on type	www.wago.com/793-5501
	Item no.: 793-5501/000-002 WMB marking card; as card; for terminal block width 5 - 17.5 mm; stretchable 5 - 5.2 mm; plain; snap-on type	www.wago.com/793-5501/000-002
	Item no.: 793-5501/000-005 WMB marking card; as card; stretchable 5 - 5.2 mm; plain; snap-on type	www.wago.com/793-5501/000-005
	Item no.: 793-5501/000-006 WMB marking card; as card; stretchable 5 - 5.2 mm; plain; snap-on type	www.wago.com/793-5501/000-006
	Item no.: 793-5501/000-007 WMB marking card; as card; stretchable 5 - 5.2 mm; plain; snap-on type	www.wago.com/793-5501/000-007
	Item no.: 793-5501/000-012 WMB marking card; as card; stretchable 5 - 5.2 mm; plain; snap-on type	www.wago.com/793-5501/000-012
	Item no.: 793-5501/000-017 WMB marking card; as card; stretchable 5 - 5.2 mm; plain; snap-on type	www.wago.com/793-5501/000-017
	Item no.: 793-5501/000-023 WMB marking card; as card; stretchable 5 - 5.2 mm; plain; snap-on type	www.wago.com/793-5501/000-023
	Item no.: 793-5501/000-024 WMB marking card; as card; stretchable 5 - 5.2 mm; plain; snap-on type	www.wago.com/793-5501/000-024

Protective Warning Marker

	Item no.: 281-415 Protective warning marker; with high-voltage symbol, black; for 5 terminal blocks	www.wago.com/281-415
--	---	--

assembling

	Item no.: 209-106 Mounting carrier; for isolated mounting on DIN 35 rails	www.wago.com/209-106
	Item no.: 709-153 Cover; Type 1; suitable for cover carrier, type 1; 1 m long	www.wago.com/709-153

Downloads smartDATA

CAD data

3D Download 281-691	URL	Download
---------------------	-----	----------



Subject to changes.

WAGO Kontakttechnik GmbH & Co. KG

Hansastr. 27

32423 Minden

Phone: +49571 887-0 | Fax: +49571 887-169

Email: info.de@wago.com | Web: www.wago.com

Do you have any questions about our products?

We are always happy to take your call at +49 (571) 887-44222.