

Data sheet | Item number: 282-128/281-417

2-conductor fuse terminal block; for miniature metric fuses; with neon lamp,  
AC 250V/DC 220V; 1" x 1"

[www.wago.com/282-128/281-417](http://www.wago.com/282-128/281-417)

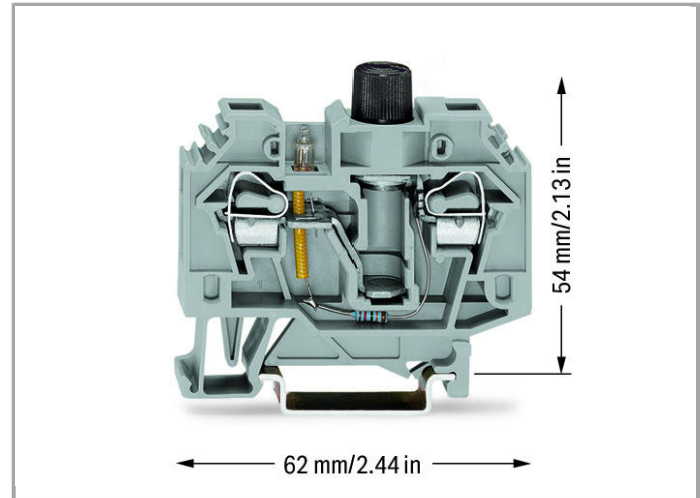

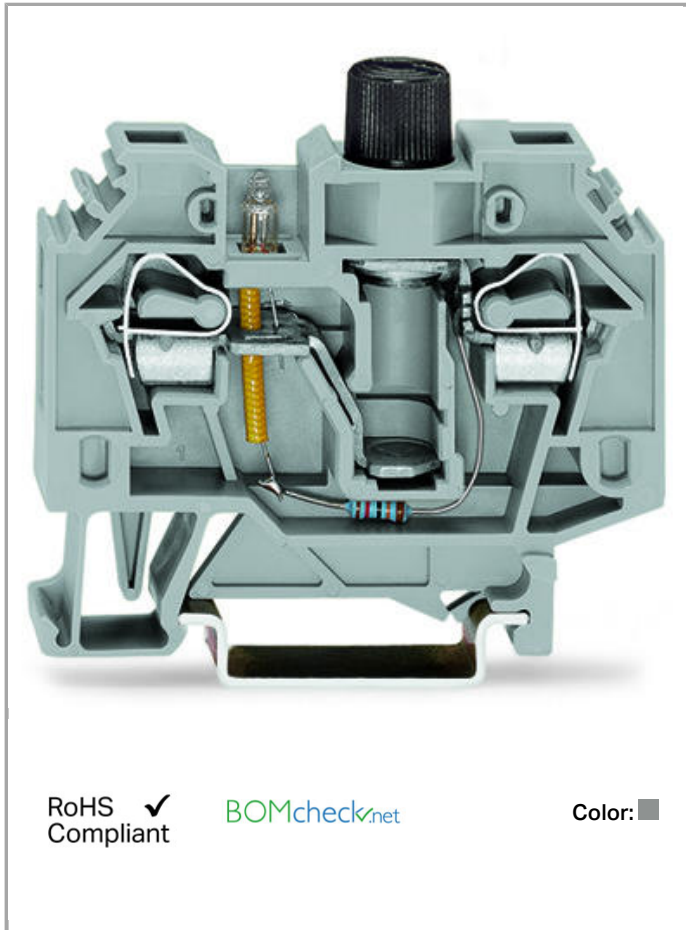
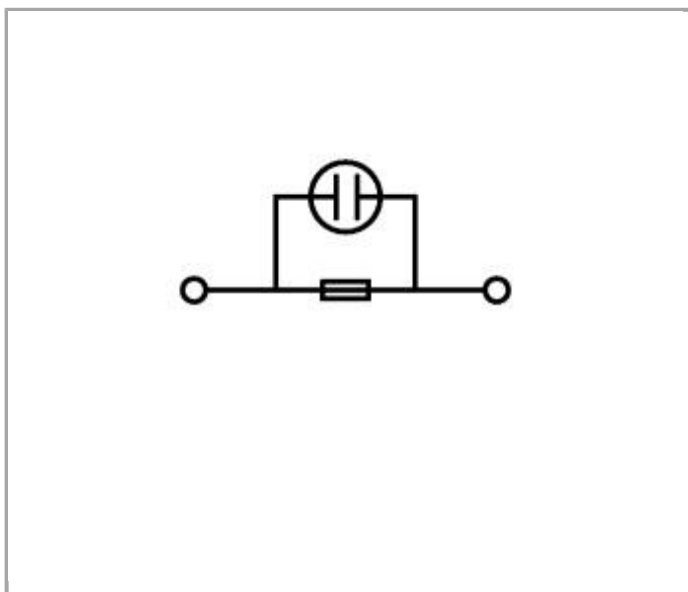

## Data

### Electrical data

Voltage type (1)	AC
------------------	----

### Ratings per IEC/EN 60664-1

Rated voltage (III / 3)	250 V
Rated current	10 A
Rated voltage (III / 3) 2	220 V
Legend (ratings)	(III / 3) $\triangleq$ Overvoltage category III / Pollution degree 3

### Connection data

Connection technology	CAGE CLAMP®
Actuation type	Operating tool
Connectable conductor materials	Copper Aluminum
Solid conductor	0.2 ... 6 mm <sup>2</sup> / 24 ... 10 AWG
Fine-stranded conductor	0.2 ... 6 mm <sup>2</sup> / 24 ... 10 AWG
Strip length	12 ... 13 mm / 0.47 ... 0.51 Inch
Total number of connection points	2
Total number of potentials	2
Number of levels	1
Type of wiring	Side-entry wiring

### Geometrical Data

Width	13 mm / 0.512 inch
-------	--------------------

Height from upper-edge of DIN-35 rail	56.5 mm / 2.224 inch
Depth	62 mm / 2.441 inch

### Mechanical data

Design	horizontal
Type of mounting	DIN-35 rail
Marking level	Side marking

### Material Data

Color	gray
Fire load	0.437 MJ
Weight	27.36 g

### Commercial data

Country of origin	CN
GTIN	4050821110330
Customs Tariff No.	85369095990
Product Group	1 (Rail Mounted Terminal Blocks)

### Approvals / Certificates

#### Ship Approvals



Logo	Approval	Certificate name
	<b>ABS</b> American Bureau of Shipping	14-HG1293677-PDA

















#### UL-Approvals















Logo	Approval	Certificate name
	<b>UR</b> Underwriters Laboratories Inc.	E45172

### Compatible products

#### ferrule

	<b>Item no.: 216-262</b> Ferrule; Sleeve for 0.75 mm <sup>2</sup> / AWG 20; insulated; electro-tin plated; electrolytic copper; gastight crimped; acc. to DIN 46228, Part 4/09.90	<a href="http://www.wago.com/216-262">www.wago.com/216-262</a>
	<b>Item no.: 216-263</b> Ferrule; Sleeve for 1 mm <sup>2</sup> / AWG 18; insulated; electro-tin plated; electrolytic copper; gastight crimped; acc. to DIN 46228, Part 4/09.90	<a href="http://www.wago.com/216-263">www.wago.com/216-263</a>

	<b>Item no.: 216-264</b> Ferrule; Sleeve for 1.5 mm <sup>2</sup> / AWG 16; insulated; electro-tin plated; electrolytic copper; gastight crimped; acc. to DIN 46228, Part 4/09.90	<a href="http://www.wago.com/216-264">www.wago.com/216-264</a>
	<b>Item no.: 216-266</b> Ferrule; Sleeve for 2.5 mm <sup>2</sup> / AWG 14; insulated; electro-tin plated; electrolytic copper; gastight crimped; acc. to DIN 46228, Part 4/09.90	<a href="http://www.wago.com/216-266">www.wago.com/216-266</a>
	<b>Item no.: 216-267</b> Ferrule; Sleeve for 4 mm <sup>2</sup> / AWG 12; insulated; electro-tin plated; electrolytic copper; gastight crimped; acc. to DIN 46228, Part 4/09.90	<a href="http://www.wago.com/216-267">www.wago.com/216-267</a>
<b>Jumper</b>		
	<b>Item no.: 210-103</b> Wire commoning chain; insulated; 50 connections	<a href="http://www.wago.com/210-103">www.wago.com/210-103</a>
	<b>Item no.: 210-123</b> Wire commoning chain; insulated; 50 connections	<a href="http://www.wago.com/210-123">www.wago.com/210-123</a>
	<b>Item no.: 282-402</b> Adjacent jumper; insulated; Nominal current 41 A	<a href="http://www.wago.com/282-402">www.wago.com/282-402</a>
	<b>Item no.: 282-409</b> Alternate jumper; insulated; Nominal current 41 A	<a href="http://www.wago.com/282-409">www.wago.com/282-409</a>
	<b>Item no.: 282-422</b> Adjacent jumper; insulated; Nominal current 41 A	<a href="http://www.wago.com/282-422">www.wago.com/282-422</a>
	<b>Item no.: 282-424</b> Adjacent jumper; insulated; Nominal current 41 A	<a href="http://www.wago.com/282-424">www.wago.com/282-424</a>
	<b>Item no.: 709-110</b> Wire commoning chain; insulated; 4 connections; 3 x 110 mm	<a href="http://www.wago.com/709-110">www.wago.com/709-110</a>
	<b>Item no.: 709-111</b> Wire commoning chain; insulated; 3 connections; 2 x 120 mm	<a href="http://www.wago.com/709-111">www.wago.com/709-111</a>
	<b>Item no.: 709-112</b> Wire commoning chain; insulated; 3 connections; 2 x 170 mm	<a href="http://www.wago.com/709-112">www.wago.com/709-112</a>
<b>General accessories</b>		
	<b>Item no.: 249-105</b> Group marker carrier	<a href="http://www.wago.com/249-105">www.wago.com/249-105</a>
	<b>Item no.: 281-407</b> Test plug; 6 mm wide; Nominal current 24 A; for 0.08 mm <sup>2</sup> - 2.5 mm <sup>2</sup>	<a href="http://www.wago.com/281-407">www.wago.com/281-407</a>
	<b>Item no.: 282-451</b> Miniature metric fuse	<a href="http://www.wago.com/282-451">www.wago.com/282-451</a>
	<b>Item no.: 282-454</b> Miniature metric fuse; without indicator; L" x 1L"; super quick	<a href="http://www.wago.com/282-454">www.wago.com/282-454</a>
	<b>Item no.: 282-457</b> Miniature metric fuse; without indicator; L" x 1L"; medium-slow	<a href="http://www.wago.com/282-457">www.wago.com/282-457</a>
<b>Marking accessories</b>		

	<p><b>Item no.: 2009-115</b> WMB-Inline; for smartPRINTER; on reel; stretchable 5 - 5.2 mm; plain; snap-on type</p>	<a href="http://www.wago.com/2009-115">www.wago.com/2009-115</a>
	<p><b>Item no.: 2009-115/000-002</b> WMB-Inline; for smartPRINTER; on reel; stretchable 5 - 5.2 mm; plain; snap-on type</p>	<a href="http://www.wago.com/2009-115/000-002">www.wago.com/2009-115/000-002</a>
	<p><b>Item no.: 2009-115/000-006</b> WMB-Inline; for smartPRINTER; on reel; stretchable 5 - 5.2 mm; plain; snap-on type</p>	<a href="http://www.wago.com/2009-115/000-006">www.wago.com/2009-115/000-006</a>
	<p><b>Item no.: 2009-115/000-007</b> WMB-Inline; for smartPRINTER; on reel; stretchable 5 - 5.2 mm; plain; snap-on type</p>	<a href="http://www.wago.com/2009-115/000-007">www.wago.com/2009-115/000-007</a>
	<p><b>Item no.: 2009-115/000-012</b> WMB-Inline; for smartPRINTER; on reel; stretchable 5 - 5.2 mm; plain; snap-on type</p>	<a href="http://www.wago.com/2009-115/000-012">www.wago.com/2009-115/000-012</a>
	<p><b>Item no.: 2009-115/000-017</b> WMB-Inline; for smartPRINTER; on reel; stretchable 5 - 5.2 mm; plain; snap-on type</p>	<a href="http://www.wago.com/2009-115/000-017">www.wago.com/2009-115/000-017</a>
	<p><b>Item no.: 2009-115/000-023</b> WMB-Inline; for smartPRINTER; on reel; stretchable 5 - 5.2 mm; plain; snap-on type</p>	<a href="http://www.wago.com/2009-115/000-023">www.wago.com/2009-115/000-023</a>
	<p><b>Item no.: 2009-115/000-024</b> WMB-Inline; for smartPRINTER; on reel; stretchable 5 - 5.2 mm; plain; snap-on type</p>	<a href="http://www.wago.com/2009-115/000-024">www.wago.com/2009-115/000-024</a>
	<p><b>Item no.: 793-501</b> WMB marking card; as card; not stretchable; plain; snap-on type</p>	<a href="http://www.wago.com/793-501">www.wago.com/793-501</a>
	<p><b>Item no.: 793-501/000-002</b> WMB marking card; as card; not stretchable; plain; snap-on type</p>	<a href="http://www.wago.com/793-501/000-002">www.wago.com/793-501/000-002</a>
	<p><b>Item no.: 793-501/000-005</b> WMB marking card; as card; not stretchable; plain; snap-on type</p>	<a href="http://www.wago.com/793-501/000-005">www.wago.com/793-501/000-005</a>
	<p><b>Item no.: 793-501/000-006</b> WMB marking card; as card; not stretchable; plain; snap-on type</p>	<a href="http://www.wago.com/793-501/000-006">www.wago.com/793-501/000-006</a>
	<p><b>Item no.: 793-501/000-007</b> WMB marking card; as card; not stretchable; plain; snap-on type</p>	<a href="http://www.wago.com/793-501/000-007">www.wago.com/793-501/000-007</a>
	<p><b>Item no.: 793-501/000-012</b> WMB marking card; as card; not stretchable; plain; snap-on type</p>	<a href="http://www.wago.com/793-501/000-012">www.wago.com/793-501/000-012</a>
	<p><b>Item no.: 793-501/000-017</b> WMB marking card; as card; not stretchable; plain; snap-on type</p>	<a href="http://www.wago.com/793-501/000-017">www.wago.com/793-501/000-017</a>



**Item no.: 793-501/000-023**  
WMB marking card; as card; not stretchable; plain; snap-on type

[www.wago.com/793-501/000-023](http://www.wago.com/793-501/000-023)



**Item no.: 793-501/000-024**  
WMB marking card; as card; not stretchable; plain; snap-on type

[www.wago.com/793-501/000-024](http://www.wago.com/793-501/000-024)



**Item no.: 793-5501**  
WMB marking card; as card; for terminal block width 5 - 17.5 mm; stretchable 5 - 5.2 mm; plain; snap-on type

[www.wago.com/793-5501](http://www.wago.com/793-5501)



**Item no.: 793-5501/000-002**  
WMB marking card; as card; for terminal block width 5 - 17.5 mm; stretchable 5 - 5.2 mm; plain; snap-on type

[www.wago.com/793-5501/000-002](http://www.wago.com/793-5501/000-002)



**Item no.: 793-5501/000-005**  
WMB marking card; as card; stretchable 5 - 5.2 mm; plain; snap-on type

[www.wago.com/793-5501/000-005](http://www.wago.com/793-5501/000-005)



**Item no.: 793-5501/000-006**  
WMB marking card; as card; stretchable 5 - 5.2 mm; plain; snap-on type

[www.wago.com/793-5501/000-006](http://www.wago.com/793-5501/000-006)



**Item no.: 793-5501/000-007**  
WMB marking card; as card; stretchable 5 - 5.2 mm; plain; snap-on type

[www.wago.com/793-5501/000-007](http://www.wago.com/793-5501/000-007)



**Item no.: 793-5501/000-012**  
WMB marking card; as card; stretchable 5 - 5.2 mm; plain; snap-on type

[www.wago.com/793-5501/000-012](http://www.wago.com/793-5501/000-012)



**Item no.: 793-5501/000-014**  
WMB marking card; as card; stretchable 5 - 5.2 mm; plain; snap-on type

[www.wago.com/793-5501/000-014](http://www.wago.com/793-5501/000-014)



**Item no.: 793-5501/000-017**  
WMB marking card; as card; stretchable 5 - 5.2 mm; plain; snap-on type

[www.wago.com/793-5501/000-017](http://www.wago.com/793-5501/000-017)



**Item no.: 793-5501/000-023**  
WMB marking card; as card; stretchable 5 - 5.2 mm; plain; snap-on type

[www.wago.com/793-5501/000-023](http://www.wago.com/793-5501/000-023)



**Item no.: 793-5501/000-024**  
WMB marking card; as card; stretchable 5 - 5.2 mm; plain; snap-on type

[www.wago.com/793-5501/000-024](http://www.wago.com/793-5501/000-024)

#### assembling



**Item no.: 209-106**  
Mounting carrier; for isolated mounting on DIN 35 rails

[www.wago.com/209-106](http://www.wago.com/209-106)



**Item no.: 709-153**  
Cover; Type 1; suitable for cover carrier, type 1; 1 m long

[www.wago.com/709-153](http://www.wago.com/709-153)

#### tools

**Item no.: 210-721**



Operating tool with partially insulated shaft; Type 3, blade (5.5 x 0.8) mm

[www.wago.com/210-721](http://www.wago.com/210-721)

### Protective Warning Marker

**Item no.: 282-405**

Protective warning marker; with high-voltage symbol, black; for 5 terminal blocks

[www.wago.com/282-405](http://www.wago.com/282-405)

### check

**Item no.: 209-170**Test plug adapter; 8.3 mm wide; for 4 mm Ø test plugs; suitable for 1.5 mm<sup>2</sup> - 10 mm<sup>2</sup> tbs[www.wago.com/209-170](http://www.wago.com/209-170)

### Carrier rail

**Item no.: 210-112**

Steel carrier rail; 35 x 7.5 mm; 1 mm thick; 2 m long; slotted; according to EN 60715; "Hole width 25 mm

[www.wago.com/210-112](http://www.wago.com/210-112)**Item no.: 210-113**

Steel carrier rail; 35 x 7.5 mm; 1 mm thick; 2 m long; unslotted; according to EN 60715

[www.wago.com/210-113](http://www.wago.com/210-113)**Item no.: 210-114**

Steel carrier rail; 35 x 15 mm; 1.5 mm thick; 2 m long; unslotted; similar to EN 60715

[www.wago.com/210-114](http://www.wago.com/210-114)**Item no.: 210-115**

Steel carrier rail; 35 x 7.5 mm; 1 mm thick; 2 m long; slotted; according to EN 60715; "Hole width 18 mm

[www.wago.com/210-115](http://www.wago.com/210-115)**Item no.: 210-118**

Steel carrier rail; 35 x 15 mm; 2.3 mm thick; 2 m long; unslotted; according to EN 60715

[www.wago.com/210-118](http://www.wago.com/210-118)**Item no.: 210-196**

Aluminum carrier rail; 35 x 8.2 mm; 1.6 mm thick; 2 m long; unslotted; similar to EN 60715

[www.wago.com/210-196](http://www.wago.com/210-196)**Item no.: 210-197**

Steel carrier rail; 35 x 15 mm; 1.5 mm thick; 2 m long; slotted; similar to EN 60715

[www.wago.com/210-197](http://www.wago.com/210-197)**Item no.: 210-198**

Copper carrier rail; 35 x 15 mm; 2.3 mm thick; 2 m long; unslotted; according to EN 60715

[www.wago.com/210-198](http://www.wago.com/210-198)**Item no.: 210-504**

Steel carrier rail; 35 x 7.5 mm; 1 mm thick; 2 m long; slotted; galvanized; according to EN 60715

[www.wago.com/210-504](http://www.wago.com/210-504)**Item no.: 210-505**

Steel carrier rail; 35 x 7.5 mm; 1 mm thick; 2 m long; unslotted; galvanized; according to EN 60715

[www.wago.com/210-505](http://www.wago.com/210-505)**Item no.: 210-506**

Steel carrier rail; 35 x 15 mm; 1.5 mm thick; 2 m long; unslotted; galvanized; similar to EN 60715

[www.wago.com/210-506](http://www.wago.com/210-506)**Item no.: 210-508**

Steel carrier rail; 35 x 15 mm; 1.5 mm thick; 2 m long; slotted; galvanized; similar to EN 60715

[www.wago.com/210-508](http://www.wago.com/210-508)

### End plate

**Item no.: 282-311**

End and intermediate plate; 4 mm thick

[www.wago.com/282-311](http://www.wago.com/282-311)



Item no.: 282-312  
End and intermediate plate; 4 mm thick

[www.wago.com/282-312](http://www.wago.com/282-312)

---

Downloads

Documentation

Bid Text

282-128/281-417	Oct 12, 2017	DOC 25.6 kB	Download
-----------------	--------------	----------------	----------

---

Subject to changes.