

Data sheet | Item number: 285-607/999-950

2-conductor ground terminal block; 25 mm²; suitable for Ex e II applications; lateral marker slots; only for DIN 35 x 15 rail; 2.3 mm thick; copper; CAGE CLAMP®

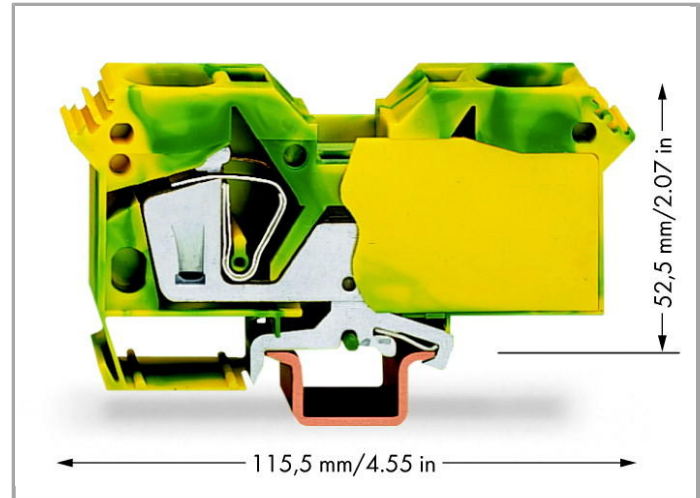

www.wago.com/285-607/999-950

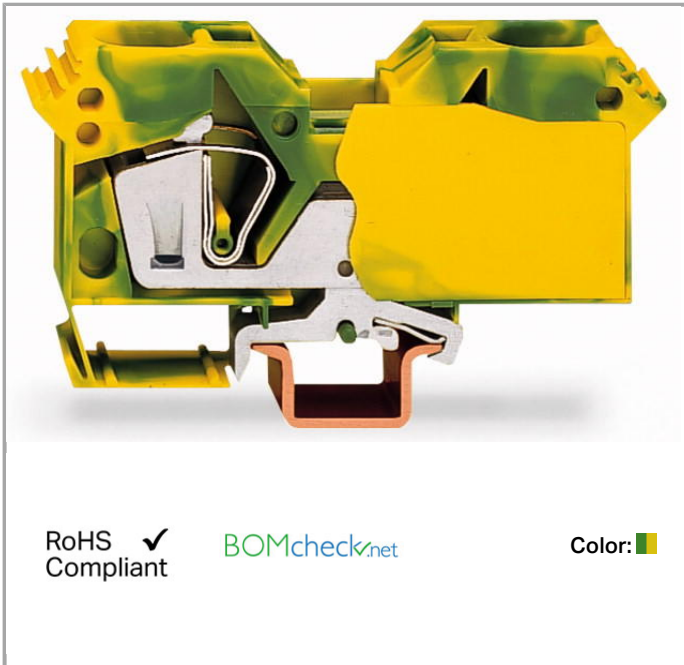

RoHS Compliant

BOMcheck.net

Color: ■

Data

Connection data

| | |
|-----------------------------------|--|
| Connection technology | CAGE CLAMP® |
| Actuation type | Operating tool |
| Connectable conductor materials | Copper |
| Solid conductor | 6 ... 25 mm ² / 8 ... 2 AWG |
| Strip length | 23 mm / 0.91 Inch |
| Total number of connection points | 2 |
| Total number of potentials | 1 |
| Number of levels | 1 |
| Type of wiring | Front-entry wiring |

Geometrical Data

| | |
|---------------------------------------|-----------------------|
| Width | 16 mm / 0.63 inch |
| Height from upper-edge of DIN-35 rail | 52.5 mm / 2.067 inch |
| Depth | 115.5 mm / 4.547 inch |

Mechanical data

| | |
|--------|------------|
| Design | horizontal |
|--------|------------|

| | |
|------------------|--------------|
| Type of mounting | DIN-35 rail |
| Marking level | Side marking |

Material Data

| | |
|---------------------|----------------------|
| Color | green-yellow |
| Insulating material | Polyamide 66 (PA 66) |
| Fire load | 1.164 MJ |
| Weight | 152.283 g |

Commercial data

| | |
|--------------------|---------------|
| Country of origin | DE |
| GTIN | 4045454116132 |
| Customs Tariff No. | 85369010000 |

Compatible products

End plate



Item no.: 285-338
Separator plate; 2 mm thick; oversized

www.wago.com/285-338

Carrier rail



Item no.: 210-114
Steel carrier rail; 35 x 15 mm; 1.5 mm thick; 2 m long; unslotted; similar to EN 60715

www.wago.com/210-114



Item no.: 210-118
Steel carrier rail; 35 x 15 mm; 2.3 mm thick; 2 m long; unslotted; according to EN 60715

www.wago.com/210-118



Item no.: 210-197
Steel carrier rail; 35 x 15 mm; 1.5 mm thick; 2 m long; slotted; similar to EN 60715

www.wago.com/210-197



Item no.: 210-198
Copper carrier rail; 35 x 15 mm; 2.3 mm thick; 2 m long; unslotted; according to EN 60715

www.wago.com/210-198



Item no.: 210-506
Steel carrier rail; 35 x 15 mm; 1.5 mm thick; 2 m long; unslotted; galvanized; similar to EN 60715

www.wago.com/210-506



Item no.: 210-508
Steel carrier rail; 35 x 15 mm; 1.5 mm thick; 2 m long; slotted; galvanized; similar to EN 60715

www.wago.com/210-508

ferrule



Item no.: 216-108
Ferrule; Sleeve for 6 mm² / AWG 10; uninsulated; electro-tin plated

www.wago.com/216-108



Item no.: 216-109
Ferrule; Sleeve for 10 mm² / AWG 8; uninsulated; electro-tin plated















www.wago.com/216-109

















Item no.: 216-110
Ferrule; Sleeve for 16 mm² / AWG 6; uninsulated; electro-tin plated

www.wago.com/216-110

Item no.: 216-208

| | | |
|--|---|--|
|  | Ferrule; Sleeve for 6 mm ² / AWG 10; insulated; electro-tin plated; electrolytic copper; gastight crimped; acc. to DIN 46228, Part 4/09.90 | www.wago.com/216-208 |
|  | Item no.: 216-209 Ferrule; Sleeve for 10 mm ² / AWG 8; insulated; electro-tin plated | www.wago.com/216-209 |
|  | Item no.: 216-210 Ferrule; Sleeve for 16 mm ² / AWG 6; insulated; electro-tin plated; electrolytic copper; gastight crimped; acc. to DIN 46228, Part 4/09.90 | www.wago.com/216-210 |
|  | Item no.: 216-288 Ferrule; Sleeve for 6 mm ² / AWG 10; insulated; electro-tin plated; electrolytic copper; gastight crimped; acc. to DIN 46228, Part 4/09.90 | www.wago.com/216-288 |
|  | Item no.: 216-289 Ferrule; Sleeve for 10 mm ² / AWG 8; insulated; electro-tin plated; electrolytic copper; gastight crimped; acc. to DIN 46228, Part 4/09.90 | www.wago.com/216-289 |
|  | Item no.: 216-413 Ferrule; Sleeve for 25 mm ² / AWG 4; uninsulated; electro-tin plated; electrolytic copper; gastight crimped; acc. to DIN 46228, Part 1/08.92 | www.wago.com/216-413 |
|  | Item no.: 216-414 Ferrule; Sleeve for 35 mm ² / AWG 2; uninsulated; electro-tin plated; electrolytic copper; gastight crimped; acc. to DIN 46228, Part 1/08.92 | www.wago.com/216-414 |
|  | Item no.: 216-424 Ferrule; Sleeve for 35 mm ² / AWG 2; uninsulated; electro-tin plated; electrolytic copper; gastight crimped; acc. to DIN 46228, Part 1/08.92 | www.wago.com/216-424 |
| tools | | |
|  | Item no.: 210-721 Operating tool with partially insulated shaft; Type 3, blade (5.5 x 0.8) mm | www.wago.com/210-721 |
| Marking accessories | | |
|  | Item no.: 2009-115 WMB-Inline; for smartPRINTER; on reel; stretchable 5 - 5.2 mm; plain; snap-on type | www.wago.com/2009-115 |
|  | Item no.: 2009-115/000-002 WMB-Inline; for smartPRINTER; on reel; stretchable 5 - 5.2 mm; plain; snap-on type | www.wago.com/2009-115/000-002 |
|  | Item no.: 2009-115/000-006 WMB-Inline; for smartPRINTER; on reel; stretchable 5 - 5.2 mm; plain; snap-on type | www.wago.com/2009-115/000-006 |
|  | Item no.: 2009-115/000-007 WMB-Inline; for smartPRINTER; on reel; stretchable 5 - 5.2 mm; plain; snap-on type | www.wago.com/2009-115/000-007 |
|  | Item no.: 2009-115/000-012 WMB-Inline; for smartPRINTER; on reel; stretchable 5 - 5.2 mm; plain; snap-on type | www.wago.com/2009-115/000-012 |
|  | Item no.: 2009-115/000-017 WMB-Inline; for smartPRINTER; on reel; stretchable 5 - 5.2 mm; plain; snap-on type | www.wago.com/2009-115/000-017 |

| | | |
|--|---|--|
|  | <p>Item no.: 2009-115/000-023 WMB-Inline; for smartPRINTER; on reel; stretchable 5 - 5.2 mm; plain; snap-on type</p> | www.wago.com/2009-115/000-023 |
|  | <p>Item no.: 2009-115/000-024 WMB-Inline; for smartPRINTER; on reel; stretchable 5 - 5.2 mm; plain; snap-on type</p> | www.wago.com/2009-115/000-024 |
|  | <p>Item no.: 793-501 WMB marking card; as card; not stretchable; plain; snap-on type</p> | www.wago.com/793-501 |
|  | <p>Item no.: 793-501/000-002 WMB marking card; as card; not stretchable; plain; snap-on type</p> | www.wago.com/793-501/000-002 |
|  | <p>Item no.: 793-501/000-005 WMB marking card; as card; not stretchable; plain; snap-on type</p> | www.wago.com/793-501/000-005 |
|  | <p>Item no.: 793-501/000-006 WMB marking card; as card; not stretchable; plain; snap-on type</p> | www.wago.com/793-501/000-006 |
|  | <p>Item no.: 793-501/000-007 WMB marking card; as card; not stretchable; plain; snap-on type</p> | www.wago.com/793-501/000-007 |
|  | <p>Item no.: 793-501/000-012 WMB marking card; as card; not stretchable; plain; snap-on type</p> | www.wago.com/793-501/000-012 |
|  | <p>Item no.: 793-501/000-017 WMB marking card; as card; not stretchable; plain; snap-on type</p> | www.wago.com/793-501/000-017 |
|  | <p>Item no.: 793-501/000-023 WMB marking card; as card; not stretchable; plain; snap-on type</p> | www.wago.com/793-501/000-023 |
|  | <p>Item no.: 793-501/000-024 WMB marking card; as card; not stretchable; plain; snap-on type</p> | www.wago.com/793-501/000-024 |
|  | <p>Item no.: 793-5501 WMB marking card; as card; for terminal block width 5 - 17.5 mm; stretchable 5 - 5.2 mm; plain; snap-on type</p> | www.wago.com/793-5501 |
|  | <p>Item no.: 793-5501/000-002 WMB marking card; as card; for terminal block width 5 - 17.5 mm; stretchable 5 - 5.2 mm; plain; snap-on type</p> | www.wago.com/793-5501/000-002 |
|  | <p>Item no.: 793-5501/000-005 WMB marking card; as card; stretchable 5 - 5.2 mm; plain; snap-on type</p> | www.wago.com/793-5501/000-005 |
|  | <p>Item no.: 793-5501/000-006 WMB marking card; as card; stretchable 5 - 5.2 mm; plain; snap-on type</p> | www.wago.com/793-5501/000-006 |



Item no.: 793-5501/000-007
WMB marking card; as card; stretchable 5 - 5.2 mm; plain; snap-on type

www.wago.com/793-5501/000-007



Item no.: 793-5501/000-012
WMB marking card; as card; stretchable 5 - 5.2 mm; plain; snap-on type

www.wago.com/793-5501/000-012



Item no.: 793-5501/000-017
WMB marking card; as card; stretchable 5 - 5.2 mm; plain; snap-on type

www.wago.com/793-5501/000-017



Item no.: 793-5501/000-023
WMB marking card; as card; stretchable 5 - 5.2 mm; plain; snap-on type

www.wago.com/793-5501/000-023



Item no.: 793-5501/000-024
WMB marking card; as card; stretchable 5 - 5.2 mm; plain; snap-on type

www.wago.com/793-5501/000-024

potential distribution



Item no.: 283-407
Power tap; with 500 mm cable; for 16 mm² (283/783 Series) and 35 mm²

www.wago.com/283-407

assembling



Item no.: 209-106
Mounting carrier; for isolated mounting on DIN 35 rails

www.wago.com/209-106

General accessories



Item no.: 249-105
Group marker carrier

www.wago.com/249-105

Downloads

smartDATA

CAD data

3D Download 285-607/999-950

URL

Download

Subject to changes.