

Data sheet | Item number: 713-1403/117-000

THR male header, 2-row; 0.8 x 0.8 mm solder pin; straight; 100% protected against mismatching; Threaded flange; Pin spacing 3.5 mm; 2 x 3-pole



www.wago.com/713-1403/117-000



RoHS Compliant

Color:

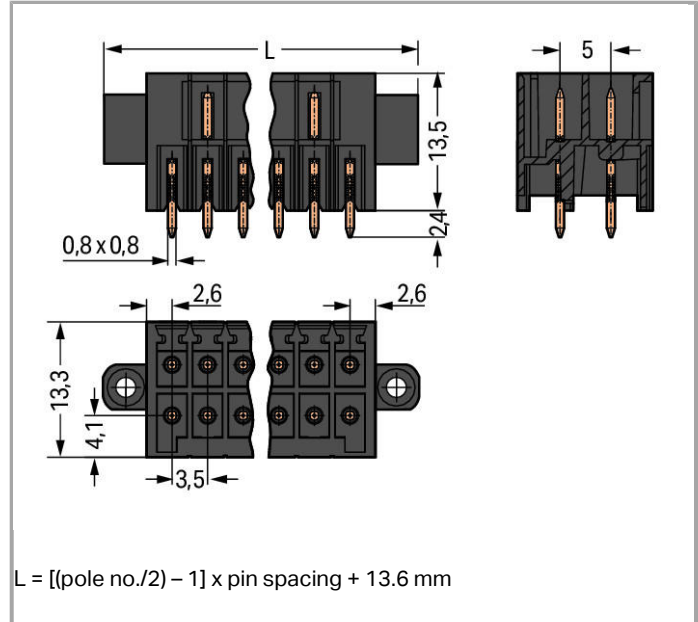

Item description

- THR male headers for reflow soldering in SMT applications
- Available in tape-and-reel packaging for automated pick-and-place PCB assembly
- Separated pin slots prevent damage and make the headers touch-proof when unplugged
- 100% protected against mismatching
- Coding pins available

Other variants can be requested via the WAGO sales department or, if necessary, configured at <https://configurator.wago.com/>: Gold-plated or partially gold-plated contact surfaces, Other pole numbers, Other solder pin lengths

Data

Electrical data

Ratings per IEC/EN 60664-1

Rated voltage (III / 3)	80 V
Rated impulse voltage (III / 3)	2.5 kV
Rated voltage (III / 2)	160 V
Rated impulse voltage (III / 2)	2.5 kV



Rated voltage (II / 2)	250 V
Rated impulse voltage (II / 2)	2.5 kV
Rated current	10 A
Legend (ratings)	(III / 2) \triangleq Overvoltage category III / Pollution degree 2

Approvals per UL 1059

Rated voltage UL (Use Group B)	150 V
Rated current UL (Use Group B)	10 A
Rated voltage UL (Use Group C)	50 V
Rated current UL (Use Group C)	10 A

Approvals per CSA

Rated voltage CSA (Use Group B)	150 V
Rated current CSA (Use Group B)	12 A

Connection data

No. of poles	6
Total number of potentials	6
Number of levels	2

Geometrical Data

Pin spacing	3.5 mm (0.138 inch)
Width	20.6 mm / 0.811 inch
Height	15.9 mm / 0.626 inch
Height from the surface	13.5 mm / 0.531 inch
Depth	13.3 mm / 0.524 inch
Solder pin length	2.4 mm
Solder pin dimensions	0.8 x 0.8 mm
Plated through-hole diameter (THR)	1.2 ^(+0.1) mm

Plug connection

Contact type (pluggable connector)	Male connector/plug
Connector connection type	for PCBs
Mismating protection	Yes
Mating direction to the PCB	90°
Locking of plug-in connection	Threaded flange

PCB contact

PCB contact	THR
-------------	-----

Solder pin arrangement	over the entire male connector, in line
Number of solder pins per potential	1

Material Data

Color	black
Material group	I
Insulating material	Polyphthalamide (PPA GF)
Flammability class per UL94	V0
Contact material	Electrolytic copper (Ecu)
Contact plating	tin-plated
Fire load	0.047 MJ
Weight	2.326 g

Environmental Requirements

Limit temperature range	-60 ... +100 °C
-------------------------	-----------------

Commercial data

Country of origin	PL
GTIN	4050821156406
Customs Tariff No.	85366990990
Product Group	3 (Multi Conn. System)

Approvals / Certificates

UL-Approvals

Logo	Approval	Certificate name
	UR Underwriters Laboratories Inc.	E45172

Compatible products

Coding



Item no.: 714-101
Coding key

www.wago.com/714-101

Downloads
smartDATA

PCB libraries



TARGET Library for WAGO Pluggable PCB Connectors (Multi-Connection System) Compatible with TARGET PCB Design Software Version 17.x	1.1.0 Oct 6, 2014	ZIP 7.4 MB	Download
EAGLE Library for WAGO Pluggable PCB Connectors (MULTI CONNECTION SYSTEM) Compatible with EAGLE PCB Design Software Version 6.x or higher	2.1 Nov 17, 2017	ZIP 6.2 MB	Download
DesignSpark Library for WAGO Pluggable PCB Connectors (MULTI CONNECTION SYSTEM) Compatible with DesignSpark PCB Version 4.x or higher	2.1 Oct 6, 2014	ZIP 6.1 MB	Download
CAD data			
3D Download 713-1403/117-000		URL	Download

Subject to changes.