

Data sheet | Item number: 721-311/008-000

1-conductor female plug; angled; 100% protected against mismatching; Snap-in mounting feet; 2.5 mm²; Pin spacing 5 mm; 11-pole

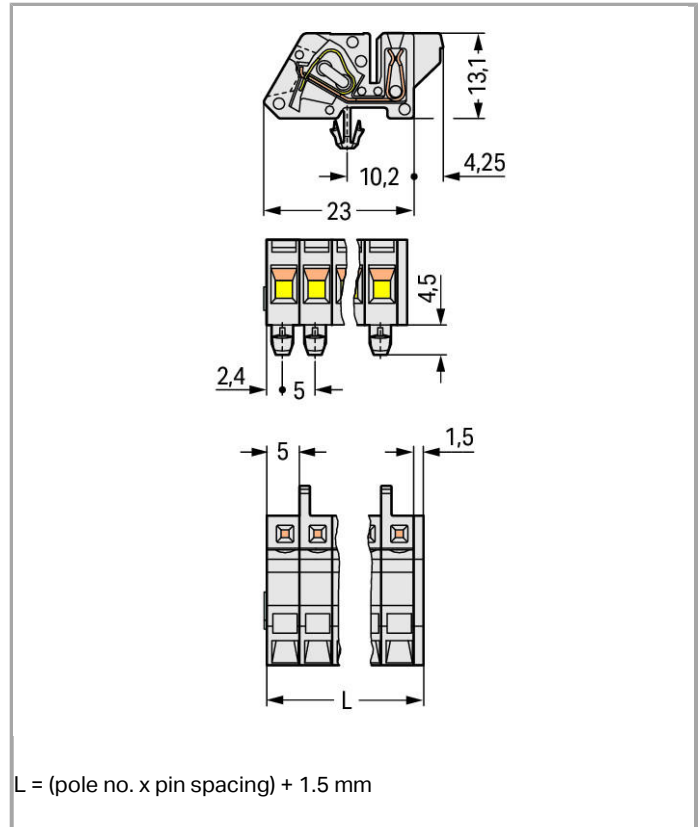

www.wago.com/721-311/008-000

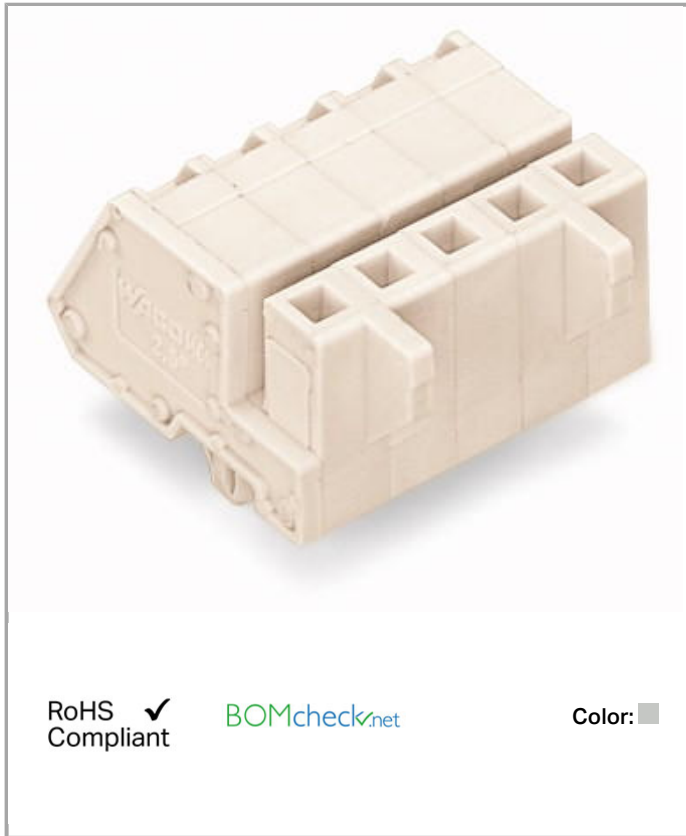

Item description

- Universal connection for all conductor types
- Versions available with snap-in mounting feet or flanges for panel or through-panel mounting
- Mounting adapter allows versions with snap-in mounting feet to be DIN-rail mounted
- Easy conductor termination, even when halves are mated
- 100 % protected against mismatching

Other variants can be requested via the WAGO sales department or, if necessary, configured at <https://configurator.wago.com/>: Gold-plated or partially gold-plated contact surfaces, Other pole numbers

Data

Electrical data

Ratings per IEC/EN 60664-1

Rated voltage (III / 3)

320 V



Rated impulse voltage (III / 3)	4 kV
Rated voltage (III / 2)	320 V
Rated impulse voltage (III / 2)	4 kV
Rated voltage (II / 2)	630 V
Rated impulse voltage (II / 2)	4 kV
Rated current	12 A
Legend (ratings)	(III / 2) $\hat{=}$ Overvoltage category III / Pollution degree 2

Approvals per UL 1059

Rated voltage UL (Use Group B)	300 V
Rated current UL (Use Group B)	15 A
Rated voltage UL (Use Group D)	300 V
Rated current UL (Use Group D)	10 A

Approvals per CSA

Rated voltage CSA (Use Group B)	300 V
Rated current CSA (Use Group B)	15 A
Rated voltage CSA (Use Group D)	300 V
Rated current CSA (Use Group D)	10 A

Connection data

Connection technology	CAGE CLAMP®
Actuation type	Operating tool
Solid conductor	0.08 ... 2.5 mm ² / 28 ... 12 AWG
Fine-stranded conductor	0.08 ... 2.5 mm ² / 28 ... 12 AWG
Fine-stranded conductor with ferrule with plastic collar	0.25 ... 1.5 mm ²
Fine-stranded conductor with ferrule without plastic collar	0.25 ... 2.5 mm ²
Strip length	7 ... 8 mm / 0.28 ... 0.31 Inch
No. of poles	11
Total number of connection points	11
Total number of potentials	11
Number of connection types	1
Number of levels	1
Conductor entry direction to mating direction	90°

Geometrical Data

Pin spacing	5 mm (0.197 inch)
Width	56.5 mm / 2.224 inch
Height	17.6 mm / 0.693 inch
Height from the surface	13.1 mm / 0.516 inch

Depth	27.25 mm / 1.073 inch
-------	-----------------------

Mechanical data

Gehäuseblechstärke	0.6 ... 1.2 mm / 0.024 ... 0.047 inch
Design	angled, mountable
Mounting type	Snap-in mounting foot
Type of mounting	Feed-through mounting Panel mounting

Plug connection

Contact type (pluggable connector)	Female connector/socket
Connector connection type	for conductors
Mismating protection	Yes

Material Data

Color	light gray
Material group	I
Insulating material	Polyamide 66 (PA 66)
Flammability class per UL94	V0
Clamping spring material	Chrome nickel spring steel (CrNi)
Contact material	Copper alloy
Contact plating	tin-plated
Fire load	0.327 MJ
Weight	16.535 g

Environmental Requirements

Limit temperature range	-60 ... +85 °C
-------------------------	----------------

Commercial data

Country of origin	DE
GTIN	4017332760874
Customs Tariff No.	85366990990
Product Group	3 (Multi Conn. System)

Approvals / Certificates

Country specific Approvals



Logo	Approval	Certificate name
	CSA DEKRA Certification B.V.	1466354



KEMA/KEUR
DEKRA Certification B.V.

2190761.01

Ship Approvals

Logo	Approval	Certificate name
	ABS American Bureau of Shipping	14-HG1241537-PDA
	DNV GL Det Norske Veritas, Germanischer Lloyd	TAE000016Z

UL-Approvals

Logo	Approval	Certificate name
	UL UL International Germany GmbH	E45172
	UR UL International Germany GmbH	E45171

Compatible products

Strain relief plate



Item no.: 232-610
Strain relief housing

www.wago.com/232-610

tools



Item no.: 231-131
Push-button; for female and male connectors; loose

www.wago.com/231-131



Item no.: 231-291
Operating tool; for male and female connectors with CAGE CLAMP®; loose

www.wago.com/231-291

Jumper



Item no.: 231-902
Comb-style jumper bar; for 5 mm and 5.08 mm pin spacing; reduces conductor size to 1.5 mm

www.wago.com/231-902



Item no.: 231-903
Comb-style jumper bar; 3-way; suitable for 231 Series female connectors; with 5 mm pin spacing; insulated

www.wago.com/231-903

Item no.: 231-905



Comb-style jumper bar; 5-way; suitable for 231 Series female connectors; with 5 mm pin spacing; insulated

www.wago.com/231-905



Item no.: 231-907

Comb-style jumper bar; 7-way; suitable for 231 Series female connectors; with 5 mm pin spacing; insulated

www.wago.com/231-907



Item no.: 231-910

Comb-style jumper bar; 10-way; suitable for 231 Series female connectors; with 5 mm pin spacing; insulated

www.wago.com/231-910

ferrule



Item no.: 216-106

Ferrule; Sleeve for 2.5 mm² / AWG 14; uninsulated; electro-tin plated

www.wago.com/216-106



Item no.: 216-107

Ferrule; Sleeve for 4 mm² / AWG 12; uninsulated; electro-tin plated

www.wago.com/216-107



Item no.: 216-108

Ferrule; Sleeve for 6 mm² / AWG 10; uninsulated; electro-tin plated

www.wago.com/216-108



Item no.: 216-109

Ferrule; Sleeve for 10 mm² / AWG 8; uninsulated; electro-tin plated

www.wago.com/216-109



Item no.: 216-110

Ferrule; Sleeve for 16 mm² / AWG 6; uninsulated; electro-tin plated

www.wago.com/216-110



Item no.: 216-121

Ferrule; Sleeve for 0.5 mm² / AWG 22; uninsulated; electro-tin plated

www.wago.com/216-121



Item no.: 216-122

Ferrule; Sleeve for 0.75 mm² / AWG 20; uninsulated; electro-tin plated

www.wago.com/216-122



Item no.: 216-123

Ferrule; Sleeve for 1 mm² / AWG 18; uninsulated; electro-tin plated

www.wago.com/216-123



Item no.: 216-124

Ferrule; Sleeve for 1.5 mm² / AWG 16; uninsulated; electro-tin plated

www.wago.com/216-124



Item no.: 216-131

Ferrule; Sleeve for 0.25 mm² / AWG 24; uninsulated; electro-tin plated

www.wago.com/216-131



Item no.: 216-132

Ferrule; Sleeve for 0.34 mm² / AWG 24; uninsulated; electro-tin plated

www.wago.com/216-132



Item no.: 216-141

Ferrule; Sleeve for 0.5 mm² / AWG 22; uninsulated; electro-tin plated; electrolytic copper; gastight crimped; acc. to DIN 46228, Part 1/08.92

www.wago.com/216-141



Item no.: 216-142

Ferrule; Sleeve for 0.75 mm² / AWG 20; uninsulated; electro-tin plated; electrolytic copper; gastight crimped; acc. to DIN 46228, Part 1/08.92

www.wago.com/216-142



Item no.: 216-143

Ferrule; Sleeve for 1 mm² / AWG 18; uninsulated; electro-tin plated; electrolytic copper; gastight crimped; acc. to DIN 46228, Part 1/08.92













www.wago.com/216-143











Item no.: 216-144



Ferrule; Sleeve for 1.5 mm² / AWG 16; uninsulated; electro-tin plated; electrolytic copper; gastight crimped; acc. to DIN 46228, Part 1/08.92

www.wago.com/216-144

	Item no.: 216-151 Ferrule; Sleeve for 0.25 mm ² / AWG 24; uninsulated; electro-tin plated	www.wago.com/216-151
	Item no.: 216-152 Ferrule; Sleeve for 0.34 mm ² / AWG 24; uninsulated; electro-tin plated	www.wago.com/216-152
	Item no.: 216-207 Ferrule; Sleeve for 4 mm ² / AWG 12; insulated; electro-tin plated	www.wago.com/216-207
	Item no.: 216-208 Ferrule; Sleeve for 6 mm ² / AWG 10; insulated; electro-tin plated; electrolytic copper; gastight crimped; acc. to DIN 46228, Part 4/09.90	www.wago.com/216-208
	Item no.: 216-209 Ferrule; Sleeve for 10 mm ² / AWG 8; insulated; electro-tin plated	www.wago.com/216-209
	Item no.: 216-210 Ferrule; Sleeve for 16 mm ² / AWG 6; insulated; electro-tin plated; electrolytic copper; gastight crimped; acc. to DIN 46228, Part 4/09.90	www.wago.com/216-210
	Item no.: 216-221 Ferrule; Sleeve for 0.5 mm ² / AWG 22; insulated; electro-tin plated	www.wago.com/216-221
	Item no.: 216-222 Ferrule; Sleeve for 0.75 mm ² / AWG 20; insulated; electro-tin plated	www.wago.com/216-222
	Item no.: 216-223 Ferrule; Sleeve for 1 mm ² / AWG 18; insulated; electro-tin plated	www.wago.com/216-223
	Item no.: 216-224 Ferrule; Sleeve for 1.5 mm ² / AWG 16; insulated; electro-tin plated	www.wago.com/216-224
	Item no.: 216-241 Ferrule; Sleeve for 0.5 mm ² / AWG 22; insulated; electro-tin plated; electrolytic copper; gastight crimped; acc. to DIN 46228, Part 4/09.90	www.wago.com/216-241
	Item no.: 216-242 Ferrule; Sleeve for 0.75 mm ² / AWG 20; insulated; electro-tin plated; electrolytic copper; gastight crimped; acc. to DIN 46228, Part 4/09.90	www.wago.com/216-242
	Item no.: 216-243 Ferrule; Sleeve for 1 mm ² / AWG 18; insulated; electro-tin plated; electrolytic copper; gastight crimped; acc. to DIN 46228, Part 4/09.90	www.wago.com/216-243
	Item no.: 216-244 Ferrule; Sleeve for 1.5 mm ² / AWG 16; insulated; electro-tin plated; electrolytic copper; gastight crimped; acc. to DIN 46228, Part 4/09.90	www.wago.com/216-244
	Item no.: 216-246 Ferrule; Sleeve for 2.5 mm ² / AWG 14; insulated; electro-tin plated; electrolytic copper; gastight crimped; acc. to DIN 46228, Part 4/09.90	www.wago.com/216-246
	Item no.: 216-262 Ferrule; Sleeve for 0.75 mm ² / AWG 20; insulated; electro-tin plated; electrolytic copper; gastight crimped; acc. to DIN 46228, Part 4/09.90	www.wago.com/216-262
	Item no.: 216-263 Ferrule; Sleeve for 1 mm ² / AWG 18; insulated; electro-tin plated; electrolytic copper; gastight crimped; acc. to DIN 46228, Part 4/09.90	www.wago.com/216-263
	Item no.: 216-264 Ferrule; Sleeve for 1.5 mm ² / AWG 16; insulated; electro-tin plated; electrolytic copper; gastight crimped; acc. to DIN 46228, Part 4/09.90	www.wago.com/216-264
	Item no.: 216-266	

	Ferrule; Sleeve for 2.5 mm ² / AWG 14; insulated; electro-tin plated; electrolytic copper; gastight crimped; acc. to DIN 46228, Part 4/09.90	www.wago.com/216-266
	Item no.: 216-267	
	Ferrule; Sleeve for 4 mm ² / AWG 12; insulated; electro-tin plated; electrolytic copper; gastight crimped; acc. to DIN 46228, Part 4/09.90	www.wago.com/216-267
	Item no.: 216-284	
	Ferrule; Sleeve for 1.5 mm ² / AWG 16; insulated; electro-tin plated; electrolytic copper; gastight crimped; acc. to DIN 46228, Part 4/09.90	www.wago.com/216-284
	Item no.: 216-286	
	Ferrule; Sleeve for 2.5 mm ² / AWG 14; insulated; electro-tin plated; electrolytic copper; gastight crimped; acc. to DIN 46228, Part 4/09.90	www.wago.com/216-286
	Item no.: 216-287	
	Ferrule; Sleeve for 4 mm ² / AWG 12; insulated; electro-tin plated; electrolytic copper; gastight crimped; acc. to DIN 46228, Part 4/09.90	www.wago.com/216-287
	Item no.: 216-288	
	Ferrule; Sleeve for 6 mm ² / AWG 10; insulated; electro-tin plated; electrolytic copper; gastight crimped; acc. to DIN 46228, Part 4/09.90	www.wago.com/216-288
	Item no.: 216-289	
	Ferrule; Sleeve for 10 mm ² / AWG 8; insulated; electro-tin plated; electrolytic copper; gastight crimped; acc. to DIN 46228, Part 4/09.90	www.wago.com/216-289
	Item no.: 216-321	
	Ferrule; Sleeve for 0.25 mm ² / AWG 24; insulated; electro-tin plated	www.wago.com/216-321
	Item no.: 216-322	
	Ferrule; Sleeve for 0.34 mm ² / AWG 24; insulated; electro-tin plated	www.wago.com/216-322

General accessories

	Item no.: 231-668 Lockout caps; for covering unused clamping units	www.wago.com/231-668
	Item no.: 721-611 1-conductor male connector; 100% protected against mismatching; 2.5 mm ² ; Pin spacing 5 mm; 11-pole	www.wago.com/721-611

Marking accessories

	Item no.: 210-833 Marking strips; on reel; 6 mm wide; plain; Self-adhesive	www.wago.com/210-833
	Item no.: 210-834 Marking strips; on reel; 5 mm wide; plain; Self-adhesive	www.wago.com/210-834

check

	Item no.: 210-136 Test plug; 2 mm Ø; with 500 mm cable	www.wago.com/210-136
	Item no.: 210-137 Test plug; 2.3 mm Ø; with 500 mm cable	www.wago.com/210-137

assembling

	Item no.: 209-120 Mounting foot; can be snapped on terminal blocks with snap-in mounting foot; for mounting on relay-modules; 6.4 mm wide	www.wago.com/209-120
--	---	--



Downloads

smartDATA

CAD data

3D Download 721-311/008-000

URL

Download

Subject to changes.

WAGO Kontakttechnik GmbH & Co. KG

Hansastr. 27

32423 Minden

Phone: +49571 887-0 | Fax: +49571 887-169

Email: info.de@wago.com | Web: www.wago.com

Do you have any questions about our products?

We are always happy to take your call at +49 (571) 887-44222.