

Data sheet | Item number: 722-135/005-000/039-000

Female connector for rail-mount terminal blocks; straight; 100% protected against mismatching; Locking lever; Pin spacing 5 mm; 5-pole

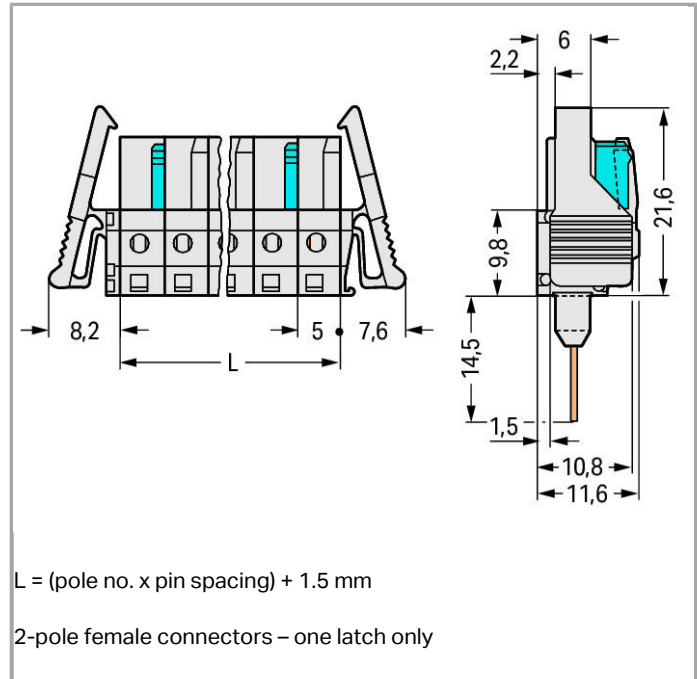

www.wago.com/722-135/005-000/039-000

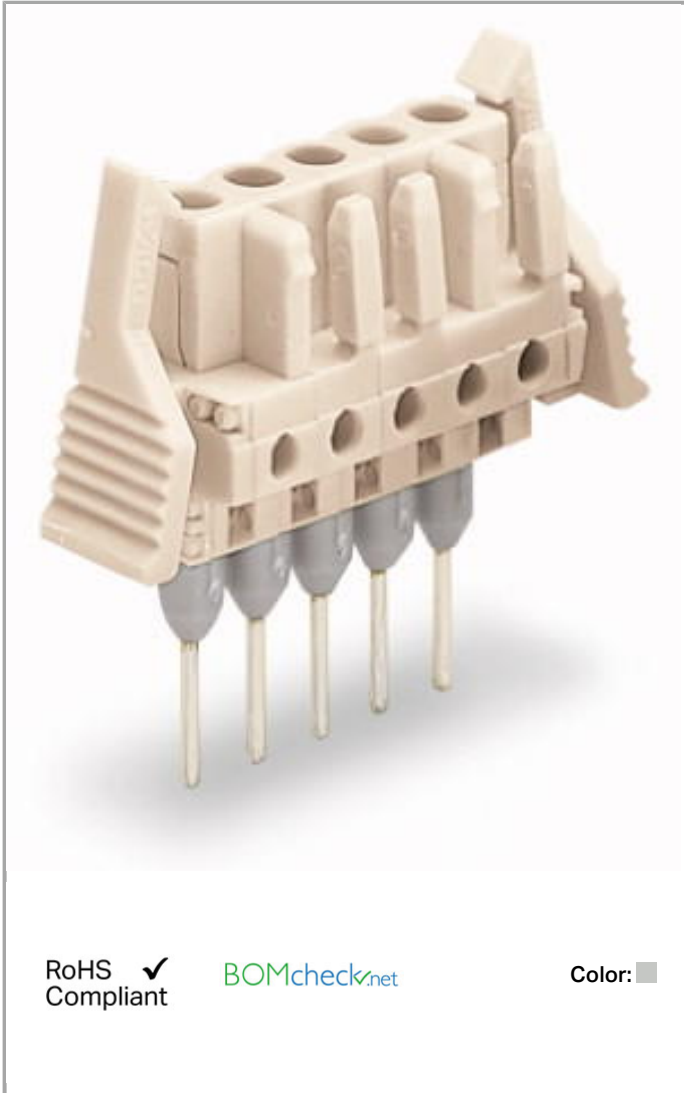

Item description

- Pluggable connectors for rail-mount terminal blocks equipped with CAGE CLAMP® connection
- Female connectors with long contact pins connect to the termination ports of 280 Series Rail-Mount Terminal Blocks
- Female connectors are touch-proof when unmated, providing a pluggable, live output
- 100 % protected against mismatching
- With coding fingers

Other variants can be requested via the WAGO sales department or, if necessary, configured at <https://configurator.wago.com/>: Other pole numbers

Data

Electrical data

Ratings per IEC/EN 60664-1

Rated voltage (III / 3)	320 V
Rated impulse voltage (III / 3)	4 kV
Rated voltage (III / 2)	320 V
Rated impulse voltage (III / 2)	4 kV
Rated voltage (II / 2)	630 V
Rated impulse voltage (II / 2)	4 kV
Rated current	12 A
Legend (ratings)	(III / 2) ≙ Overvoltage category III / Pollution degree 2

Approvals per UL 1059

Rated voltage UL (Use Group B)	300 V
Rated current UL (Use Group B)	15 A
Rated voltage UL (Use Group D)	300 V
Rated current UL (Use Group D)	10 A

Approvals per CSA

Rated voltage CSA (Use Group B)	300 V
Rated current CSA (Use Group B)	15 A
Rated voltage CSA (Use Group D)	300 V
Rated current CSA (Use Group D)	10 A

Connection data

No. of poles	5
Total number of potentials	5
Number of levels	1

Geometrical Data

Pin spacing	5 mm (0.197 inch)
Width	40.8 mm / 1.606 inch
Height	36.1 mm / 1.421 inch
Height from the surface	21.6 mm / 0.85 inch
Depth	11.6 mm / 0.457 inch

Plug connection

Contact type (pluggable connector)	Female connector/socket
------------------------------------	-------------------------

Connector connection type	for front-entry wiring terminal block
Mismating protection	Yes
Locking of plug-in connection	locking lever
Steckrichtung zur Reihenklemme	90°

Material Data

Color	light gray
Material group	I
Insulating material	Polyamide 66 (PA 66)
Flammability class per UL94	V0
Contact material	Copper alloy
Contact plating	tin-plated
Fire load	0.116 MJ
Weight	6.19 g

Environmental Requirements

Limit temperature range	-60 ... +85 °C
-------------------------	----------------

Commercial data

Country of origin	DE
GTIN	4044918571395
Customs Tariff No.	85366990990
Product Group	3 (Multi Conn. System)

Approvals / Certificates

UL-Approvals

Logo	Approval	Certificate name
	UL UL International Germany GmbH	E45172
	UR UL International Germany GmbH	E45171

Compatible products

check



Item no.: 210-136
Test plug; 2 mm Ø; with 500 mm cable

www.wago.com/210-136



Item no.: 210-137

Test plug; 2.3 mm Ø; with 500 mm cable

www.wago.com/210-137



Item no.: 231-661

Test plugs for female connectors; for 5 mm and 5.08 mm pin spacing

www.wago.com/231-661

General accessories



Item no.: 280-650/056-000

Spacer of same profile; suitable for 3-conductor terminal blocks of horizontal type

www.wago.com/280-650/056-000



Item no.: 280-654/056-000

Spacer of same profile; suitable for 3- and 4-conductor terminal blocks of angled type

www.wago.com/280-654/056-000



Item no.: 280-835/056-000

Spacer of same profile; suitable for 4-conductor terminal blocks of horizontal type

www.wago.com/280-835/056-000



Item no.: 280-902/056-000

Spacer of same profile; suitable for 2-conductor terminal blocks of horizontal type

www.wago.com/280-902/056-000

Downloads

smartDATA

CAD data

3D Download 722-135/005-000/039-000

URL

Download

Subject to changes.