

Data sheet | Item number: 732-108/026-000

1-conductor female plug; angled; 2.5 mm²; Pin spacing 7.5 mm; 8-pole

www.wago.com/732-108/026-000

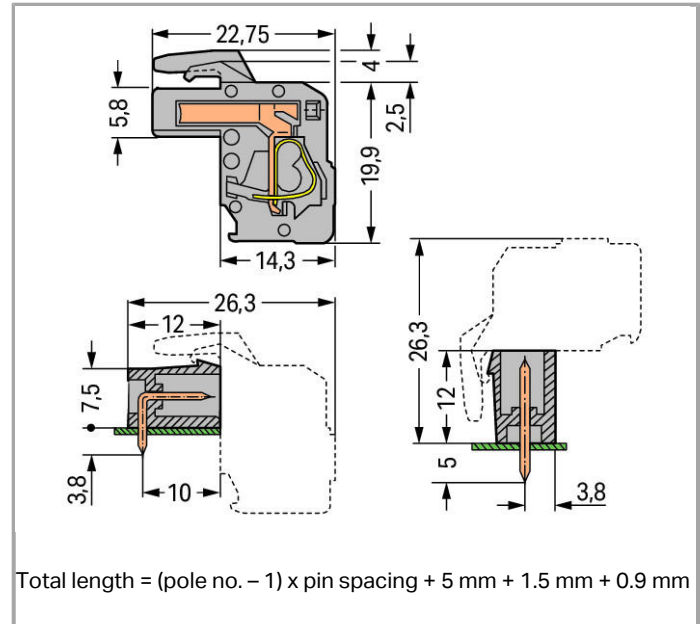

RoHS Compliant

[BOMcheck.net](https://www.bomcheck.net)

Color: ■

Item description

- Universal connection for all conductor types
- Easy cable pre-assembly and on-unit wiring via vertical and horizontal CAGE CLAMP[®] actuation
- Integrated test ports
- With coding fingers

Other variants can be requested via the WAGO sales department or, if necessary, configured at <https://configurator.wago.com/>: Gold-plated or partially gold-plated contact surfaces

Data

Electrical data

Ratings per IEC/EN 60664-1

Rated voltage (III / 3)	500 V
Rated impulse voltage (III / 3)	6 kV



Rated voltage (III / 2)	630 V
Rated impulse voltage (III / 2)	6 kV
Rated voltage (II / 2)	1000 V
Rated impulse voltage (II / 2)	6 kV
Rated current	14 A
Legend (ratings)	(III / 2) $\hat{=}$ Overvoltage category III / Pollution degree 2

Approvals per UL 1059

Rated voltage UL (Use Group B)	300 V
Rated current UL (Use Group B)	15 A
Rated voltage UL (Use Group D)	300 V
Rated current UL (Use Group D)	10 A

Approvals per CSA

Rated voltage CSA (Use Group B)	300 V
Rated current CSA (Use Group B)	15 A
Rated voltage CSA (Use Group D)	300 V
Rated current CSA (Use Group D)	10 A

Connection data

Connection technology	CAGE CLAMP®
Actuation type	Operating tool
Solid conductor	0.08 ... 2.5 mm ² / 28 ... 12 AWG
Fine-stranded conductor	0.08 ... 2.5 mm ² / 28 ... 12 AWG
Fine-stranded conductor with ferrule with plastic collar	0.25 ... 1.5 mm ²
Fine-stranded conductor with ferrule without plastic collar	0.25 ... 2.5 mm ²
Strip length	8 ... 9 mm / 0.31 ... 0.35 Inch
No. of poles	8
Total number of connection points	8
Total number of potentials	8
Number of connection types	1
Number of levels	1
Conductor entry direction to mating direction	270°

Geometrical Data

Pin spacing	7.5 mm (0.295 inch)
Width	59.9 mm / 2.358 inch
Height	23.9 mm / 0.941 inch
Depth	22.75 mm / 0.896 inch

Mechanical data

Design	angled
--------	--------

Plug connection

Contact type (pluggable connector)	Female connector/socket
Connector connection type	for conductors
Mismating protection	No

Material Data

Color	gray
Material group	I
Insulating material	Polyamide 66 (PA 66)
Flammability class per UL94	V0
Clamping spring material	Chrome nickel spring steel (CrNi)
Contact material	Copper alloy
Contact plating	tin-plated
Fire load	0.331 MJ
Weight	18.224 g

Environmental Requirements

Limit temperature range	-60 ... +100 °C
-------------------------	-----------------

Commercial data

Country of origin	DE
GTIN	4044918391863
Customs Tariff No.	85366990990
Product Group	3 (Multi Conn. System)

Approvals / Certificates

Country specific Approvals



Logo	Approval	Certificate name
	KEMA/KEUR DEKRA Certification B.V.	2190761.01

Ship Approvals

Logo	Approval	Certificate name
	ABS American Bureau of Shipping	14-HG1241537-PDA













ABS

















UL-Approvals



Logo	Approval	Certificate name
	UR Underwriters Laboratories Inc.	E45171
	UR Underwriters Laboratories Inc.	E45172

Compatible products

ferrule

	Item no.: 216-101 Ferrule; Sleeve for 0.5 mm ² / AWG 22; uninsulated; electro-tin plated	www.wago.com/216-101
	Item no.: 216-102 Ferrule; Sleeve for 0.75 mm ² / AWG 20; uninsulated; electro-tin plated	www.wago.com/216-102
	Item no.: 216-103 Ferrule; Sleeve for 1 mm ² / AWG 18; uninsulated; electro-tin plated	www.wago.com/216-103
	Item no.: 216-104 Ferrule; Sleeve for 1.5 mm ² / AWG 16; uninsulated; electro-tin plated	www.wago.com/216-104
	Item no.: 216-106 Ferrule; Sleeve for 2.5 mm ² / AWG 14; uninsulated; electro-tin plated	www.wago.com/216-106
	Item no.: 216-107 Ferrule; Sleeve for 4 mm ² / AWG 12; uninsulated; electro-tin plated	www.wago.com/216-107
	Item no.: 216-108 Ferrule; Sleeve for 6 mm ² / AWG 10; uninsulated; electro-tin plated	www.wago.com/216-108
	Item no.: 216-109 Ferrule; Sleeve for 10 mm ² / AWG 8; uninsulated; electro-tin plated	www.wago.com/216-109
	Item no.: 216-110 Ferrule; Sleeve for 16 mm ² / AWG 6; uninsulated; electro-tin plated	www.wago.com/216-110
	Item no.: 216-121 Ferrule; Sleeve for 0.5 mm ² / AWG 22; uninsulated; electro-tin plated	www.wago.com/216-121
	Item no.: 216-122 Ferrule; Sleeve for 0.75 mm ² / AWG 20; uninsulated; electro-tin plated	www.wago.com/216-122
	Item no.: 216-123 Ferrule; Sleeve for 1 mm ² / AWG 18; uninsulated; electro-tin plated	www.wago.com/216-123

	Item no.: 216-124 Ferrule; Sleeve for 1.5 mm ² / AWG 16; uninsulated; electro-tin plated	www.wago.com/216-124
	Item no.: 216-131 Ferrule; Sleeve for 0.25 mm ² / AWG 24; uninsulated; electro-tin plated	www.wago.com/216-131
	Item no.: 216-132 Ferrule; Sleeve for 0.34 mm ² / AWG 24; uninsulated; electro-tin plated	www.wago.com/216-132
	Item no.: 216-141 Ferrule; Sleeve for 0.5 mm ² / AWG 22; uninsulated; electro-tin plated; electrolytic copper; gastight crimped; acc. to DIN 46228, Part 1/08.92	www.wago.com/216-141
	Item no.: 216-142 Ferrule; Sleeve for 0.75 mm ² / AWG 20; uninsulated; electro-tin plated; electrolytic copper; gastight crimped; acc. to DIN 46228, Part 1/08.92	www.wago.com/216-142
	Item no.: 216-143 Ferrule; Sleeve for 1 mm ² / AWG 18; uninsulated; electro-tin plated; electrolytic copper; gastight crimped; acc. to DIN 46228, Part 1/08.92	www.wago.com/216-143
	Item no.: 216-144 Ferrule; Sleeve for 1.5 mm ² / AWG 16; uninsulated; electro-tin plated; electrolytic copper; gastight crimped; acc. to DIN 46228, Part 1/08.92	www.wago.com/216-144
	Item no.: 216-151 Ferrule; Sleeve for 0.25 mm ² / AWG 24; uninsulated; electro-tin plated	www.wago.com/216-151
	Item no.: 216-152 Ferrule; Sleeve for 0.34 mm ² / AWG 24; uninsulated; electro-tin plated	www.wago.com/216-152
	Item no.: 216-201 Ferrule; Sleeve for 0.5 mm ² / AWG 22; insulated; electro-tin plated	www.wago.com/216-201
	Item no.: 216-202 Ferrule; Sleeve for 0.75 mm ² / AWG 20; insulated; electro-tin plated	www.wago.com/216-202
	Item no.: 216-203 Ferrule; Sleeve for 1 mm ² / AWG 18; insulated; electro-tin plated	www.wago.com/216-203
	Item no.: 216-204 Ferrule; Sleeve for 1.5 mm ² / AWG 16; insulated; electro-tin plated	www.wago.com/216-204
	Item no.: 216-205 Ferrule; Sleeve for 2.08 mm ² / AWG 14; insulated; electro-tin plated	www.wago.com/216-205
	Item no.: 216-206 Ferrule; Sleeve for 2.5 mm ² / AWG 14; insulated; electro-tin plated	www.wago.com/216-206
	Item no.: 216-207 Ferrule; Sleeve for 4 mm ² / AWG 12; insulated; electro-tin plated	www.wago.com/216-207
	Item no.: 216-208 Ferrule; Sleeve for 6 mm ² / AWG 10; insulated; electro-tin plated; electrolytic copper; gastight crimped; acc. to DIN 46228, Part 4/09.90	www.wago.com/216-208
	Item no.: 216-209 Ferrule; Sleeve for 10 mm ² / AWG 8; insulated; electro-tin plated	www.wago.com/216-209
	Item no.: 216-210 Ferrule; Sleeve for 16 mm ² / AWG 6; insulated; electro-tin plated; electrolytic copper; gastight crimped; acc. to DIN 46228, Part 4/09.90	www.wago.com/216-210

	Item no.: 216-221 Ferrule; Sleeve for 0.5 mm ² / AWG 22; insulated; electro-tin plated	www.wago.com/216-221
	Item no.: 216-222 Ferrule; Sleeve for 0.75 mm ² / AWG 20; insulated; electro-tin plated	www.wago.com/216-222
	Item no.: 216-223 Ferrule; Sleeve for 1 mm ² / AWG 18; insulated; electro-tin plated	www.wago.com/216-223
	Item no.: 216-224 Ferrule; Sleeve for 1.5 mm ² / AWG 16; insulated; electro-tin plated	www.wago.com/216-224
	Item no.: 216-241 Ferrule; Sleeve for 0.5 mm ² / AWG 22; insulated; electro-tin plated; electrolytic copper; gastight crimped; acc. to DIN 46228, Part 4/09.90	www.wago.com/216-241
	Item no.: 216-242 Ferrule; Sleeve for 0.75 mm ² / AWG 20; insulated; electro-tin plated; electrolytic copper; gastight crimped; acc. to DIN 46228, Part 4/09.90	www.wago.com/216-242
	Item no.: 216-243 Ferrule; Sleeve for 1 mm ² / AWG 18; insulated; electro-tin plated; electrolytic copper; gastight crimped; acc. to DIN 46228, Part 4/09.90	www.wago.com/216-243
	Item no.: 216-244 Ferrule; Sleeve for 1.5 mm ² / AWG 16; insulated; electro-tin plated; electrolytic copper; gastight crimped; acc. to DIN 46228, Part 4/09.90	www.wago.com/216-244
	Item no.: 216-246 Ferrule; Sleeve for 2.5 mm ² / AWG 14; insulated; electro-tin plated; electrolytic copper; gastight crimped; acc. to DIN 46228, Part 4/09.90	www.wago.com/216-246
	Item no.: 216-262 Ferrule; Sleeve for 0.75 mm ² / AWG 20; insulated; electro-tin plated; electrolytic copper; gastight crimped; acc. to DIN 46228, Part 4/09.90	www.wago.com/216-262
	Item no.: 216-263 Ferrule; Sleeve for 1 mm ² / AWG 18; insulated; electro-tin plated; electrolytic copper; gastight crimped; acc. to DIN 46228, Part 4/09.90	www.wago.com/216-263
	Item no.: 216-264 Ferrule; Sleeve for 1.5 mm ² / AWG 16; insulated; electro-tin plated; electrolytic copper; gastight crimped; acc. to DIN 46228, Part 4/09.90	www.wago.com/216-264
	Item no.: 216-266 Ferrule; Sleeve for 2.5 mm ² / AWG 14; insulated; electro-tin plated; electrolytic copper; gastight crimped; acc. to DIN 46228, Part 4/09.90	www.wago.com/216-266
	Item no.: 216-267 Ferrule; Sleeve for 4 mm ² / AWG 12; insulated; electro-tin plated; electrolytic copper; gastight crimped; acc. to DIN 46228, Part 4/09.90	www.wago.com/216-267
	Item no.: 216-284 Ferrule; Sleeve for 1.5 mm ² / AWG 16; insulated; electro-tin plated; electrolytic copper; gastight crimped; acc. to DIN 46228, Part 4/09.90	www.wago.com/216-284
	Item no.: 216-286 Ferrule; Sleeve for 2.5 mm ² / AWG 14; insulated; electro-tin plated; electrolytic copper; gastight crimped; acc. to DIN 46228, Part 4/09.90	www.wago.com/216-286
	Item no.: 216-287 Ferrule; Sleeve for 4 mm ² / AWG 12; insulated; electro-tin plated; electrolytic copper; gastight crimped; acc. to DIN 46228, Part 4/09.90	www.wago.com/216-287
	Item no.: 216-288 Ferrule; Sleeve for 6 mm ² / AWG 10; insulated; electro-tin plated; electrolytic copper; gastight crimped; acc. to DIN 46228, Part 4/09.90	www.wago.com/216-288



Item no.: 216-289

Ferrule; Sleeve for 10 mm² / AWG 8; insulated; electro-tin plated; electrolytic copper; gastight crimped; www.wago.com/216-289
acc. to DIN 46228, Part 4/09.90



Item no.: 216-301

Ferrule; Sleeve for 0.25 mm² / AWG 24; insulated; electro-tin plated

www.wago.com/216-301



Item no.: 216-302

Ferrule; Sleeve for 0.34 mm² / AWG 24; insulated; electro-tin plated

www.wago.com/216-302



Item no.: 216-321

Ferrule; Sleeve for 0.25 mm² / AWG 24; insulated; electro-tin plated

www.wago.com/216-321



Item no.: 216-322

Ferrule; Sleeve for 0.34 mm² / AWG 24; insulated; electro-tin plated

www.wago.com/216-322

check



Item no.: 210-136

Test plug; 2 mm Ø; with 500 mm cable

www.wago.com/210-136



Item no.: 210-137

Test plug; 2.3 mm Ø; with 500 mm cable

www.wago.com/210-137



Item no.: 231-662

Test plugs for female connectors; for 7.5 mm and 7.62 mm pin spacing

www.wago.com/231-662

tools



Item no.: 231-291

Operating tool; for male and female connectors with CAGE CLAMP®; loose

www.wago.com/231-291

Insulation stop



Item no.: 231-673

Insulation stop; 0.08-0.2 mm² / 0.2 mm² "s"

www.wago.com/231-673



Item no.: 231-674

Insulation stop; 0.25 - 0.5 mm²

www.wago.com/231-674



Item no.: 231-675

Insulation stop; 0.75 - 1 mm²

www.wago.com/231-675

Marking accessories



Item no.: 210-833

Marking strips; on reel; 6 mm wide; plain; Self-adhesive

www.wago.com/210-833



Item no.: 210-834

Marking strips; on reel; 5 mm wide; plain; Self-adhesive

www.wago.com/210-834

Downloads

smartDATA

CAD data



3D Download 732-108/026-000

URL

Download

Subject to changes.

WAGO Kontakttechnik GmbH & Co. KG

Hansastr. 27

32423 Minden

Phone: +49571 887-0 | Fax: +49571 887-169

Email: info.de@wago.com | Web: www.wago.com

Do you have any questions about our products?

We are always happy to take your call at +49 (571) 887-44222.