

Data sheet | Item number: 734-324/109-000

1-conductor male connector; 100% protected against mismatching; Threaded flange; 1.5 mm²; Pin spacing 3.5 mm; 24-pole



www.wago.com/734-324/109-000



RoHS Compliant

BOMcheck.net

Color:

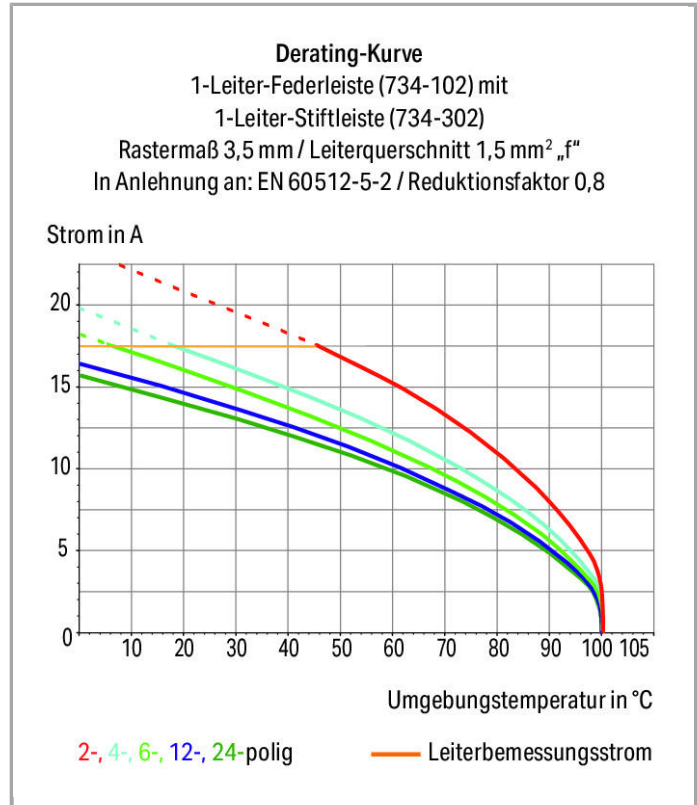

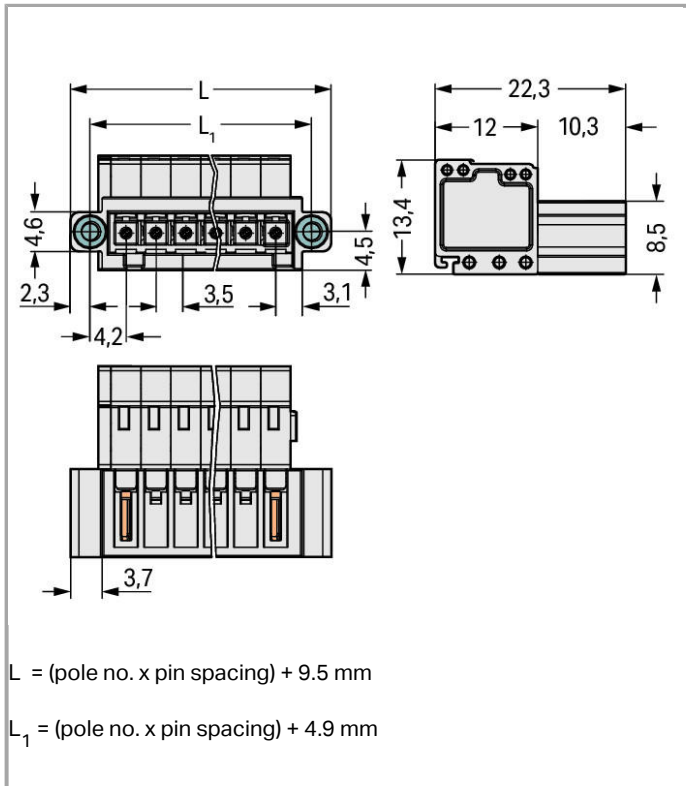

Item description

- Universal connection for all conductor types
- Easy cable pre-assembly and on-unit wiring via vertical and horizontal CAGE CLAMP® actuation
- For wire-to-wire and board-to-wire connections
- Strain relief plates and housings for factory and field assembly
- 100% protected against mismatching
- Coding via coding fingers

Other variants can be requested via the WAGO sales department or, if necessary, configured at <https://configurator.wago.com/>: Gold-plated or partially gold-plated contact surfaces, Other pole numbers

Data

Electrical data

Ratings per IEC/EN 60664-1

Rated voltage (III / 3)	160 V
Rated impulse voltage (III / 3)	2.5 kV
Rated voltage (III / 2)	160 V
Rated impulse voltage (III / 2)	2.5 kV
Rated voltage (II / 2)	320 V
Rated impulse voltage (II / 2)	2.5 kV



Rated current	10 A
Legend (ratings)	(III / 2) $\hat{=}$ Overvoltage category III / Pollution degree 2

Approvals per UL 1059

Rated voltage UL (Use Group B)	300 V
Rated current UL (Use Group B)	10 A
Rated voltage UL (Use Group D)	300 V
Rated current UL (Use Group D)	10 A

Approvals per CSA

Rated voltage CSA (Use Group B)	300 V
Rated current CSA (Use Group B)	10 A
Rated voltage CSA (Use Group D)	300 V
Rated current CSA (Use Group D)	10 A

Connection data

Connection technology	CAGE CLAMP®
Actuation type	Operating tool
Solid conductor	0.08 ... 1.5 mm ² / 28 ... 14 AWG
Fine-stranded conductor	0.08 ... 1.5 mm ² / 28 ... 14 AWG
Fine-stranded conductor with ferrule with plastic collar	0.25 ... 1.5 mm ²
Fine-stranded conductor with ferrule without plastic collar	0.25 ... 1.5 mm ²
Strip length	6 ... 7 mm / 0.24 ... 0.28 Inch
No. of poles	24
Total number of connection points	24
Total number of potentials	24
Number of connection types	1
Number of levels	1
Conductor entry direction to mating direction	0°

Geometrical Data

Pin spacing	3.5 mm (0.138 inch)
Width	93.5 mm / 3.681 inch
Height	13.4 mm / 0.528 inch
Depth	22.3 mm / 0.878 inch

Plug connection

Contact type (pluggable connector)	Male connector/plug
Connector connection type	for conductors

Mismating protection	Yes
Locking of plug-in connection	Threaded flange

Material Data

Color	light gray
Material group	I
Insulating material	Polyamide 66 (PA 66)
Flammability class per UL94	V0
Clamping spring material	Chrome nickel spring steel (CrNi)
Contact material	Electrolytic copper (Ecu)
Contact plating	tin-plated
Fire load	0.389 MJ
Weight	19.842 g

Environmental Requirements

Limit temperature range	-60 ... +100 °C
-------------------------	-----------------

Commercial data



Country of origin	DE
GTIN	4045454732523
Customs Tariff No.	85366990990
Product Group	3 (Multi Conn. System)

Approvals / Certificates

Ship Approvals

Logo	Approval	Certificate name
	DNV GL Det Norske Veritas, Germanischer Lloyd	TAE000016Z

UL-Approvals

Logo	Approval	Certificate name
	UL UL International Germany GmbH	E45171
	UR Underwriters Laboratories Inc.	E45172

Compatible products

Coding

**Item no.: 734-130**

Coding key; to be snapped above top level

www.wago.com/734-130

protection



















**Item no.: 734-420**



Cover for male connectors; for 734 Series; IP20 protection

www.wago.com/734-420

ferrule

**Item no.: 216-101**Ferrule; Sleeve for 0.5 mm² / AWG 22; uninsulated; electro-tin platedwww.wago.com/216-101**Item no.: 216-102**Ferrule; Sleeve for 0.75 mm² / AWG 20; uninsulated; electro-tin platedwww.wago.com/216-102**Item no.: 216-103**Ferrule; Sleeve for 1 mm² / AWG 18; uninsulated; electro-tin platedwww.wago.com/216-103**Item no.: 216-104**Ferrule; Sleeve for 1.5 mm² / AWG 16; uninsulated; electro-tin platedwww.wago.com/216-104**Item no.: 216-121**Ferrule; Sleeve for 0.5 mm² / AWG 22; uninsulated; electro-tin platedwww.wago.com/216-121**Item no.: 216-122**Ferrule; Sleeve for 0.75 mm² / AWG 20; uninsulated; electro-tin platedwww.wago.com/216-122**Item no.: 216-123**Ferrule; Sleeve for 1 mm² / AWG 18; uninsulated; electro-tin platedwww.wago.com/216-123**Item no.: 216-124**Ferrule; Sleeve for 1.5 mm² / AWG 16; uninsulated; electro-tin platedwww.wago.com/216-124**Item no.: 216-131**Ferrule; Sleeve for 0.25 mm² / AWG 24; uninsulated; electro-tin platedwww.wago.com/216-131**Item no.: 216-132**Ferrule; Sleeve for 0.34 mm² / AWG 24; uninsulated; electro-tin platedwww.wago.com/216-132**Item no.: 216-141**Ferrule; Sleeve for 0.5 mm² / AWG 22; uninsulated; electro-tin plated; electrolytic copper; gastight crimped; acc. to DIN 46228, Part 1/08.92www.wago.com/216-141**Item no.: 216-142**Ferrule; Sleeve for 0.75 mm² / AWG 20; uninsulated; electro-tin plated; electrolytic copper; gastight crimped; acc. to DIN 46228, Part 1/08.92www.wago.com/216-142**Item no.: 216-143**Ferrule; Sleeve for 1 mm² / AWG 18; uninsulated; electro-tin plated; electrolytic copper; gastight crimped; acc. to DIN 46228, Part 1/08.92www.wago.com/216-143**Item no.: 216-144**Ferrule; Sleeve for 1.5 mm² / AWG 16; uninsulated; electro-tin plated; electrolytic copper; gastight crimped; acc. to DIN 46228, Part 1/08.92www.wago.com/216-144**Item no.: 216-151**Ferrule; Sleeve for 0.25 mm² / AWG 24; uninsulated; electro-tin platedwww.wago.com/216-151

		
	Item no.: 216-152 Ferrule; Sleeve for 0.34 mm ² / AWG 24; uninsulated; electro-tin plated	www.wago.com/216-152
	Item no.: 216-201 Ferrule; Sleeve for 0.5 mm ² / AWG 22; insulated; electro-tin plated	www.wago.com/216-201
	Item no.: 216-202 Ferrule; Sleeve for 0.75 mm ² / AWG 20; insulated; electro-tin plated	www.wago.com/216-202
	Item no.: 216-203 Ferrule; Sleeve for 1 mm ² / AWG 18; insulated; electro-tin plated	www.wago.com/216-203
	Item no.: 216-204 Ferrule; Sleeve for 1.5 mm ² / AWG 16; insulated; electro-tin plated	www.wago.com/216-204
	Item no.: 216-221 Ferrule; Sleeve for 0.5 mm ² / AWG 22; insulated; electro-tin plated	www.wago.com/216-221
	Item no.: 216-222 Ferrule; Sleeve for 0.75 mm ² / AWG 20; insulated; electro-tin plated	www.wago.com/216-222
	Item no.: 216-223 Ferrule; Sleeve for 1 mm ² / AWG 18; insulated; electro-tin plated	www.wago.com/216-223
	Item no.: 216-224 Ferrule; Sleeve for 1.5 mm ² / AWG 16; insulated; electro-tin plated	www.wago.com/216-224
	Item no.: 216-241 Ferrule; Sleeve for 0.5 mm ² / AWG 22; insulated; electro-tin plated; electrolytic copper; gastight crimped; acc. to DIN 46228, Part 4/09.90	www.wago.com/216-241
	Item no.: 216-242 Ferrule; Sleeve for 0.75 mm ² / AWG 20; insulated; electro-tin plated; electrolytic copper; gastight crimped; acc. to DIN 46228, Part 4/09.90	www.wago.com/216-242
	Item no.: 216-243 Ferrule; Sleeve for 1 mm ² / AWG 18; insulated; electro-tin plated; electrolytic copper; gastight crimped; acc. to DIN 46228, Part 4/09.90	www.wago.com/216-243
	Item no.: 216-244 Ferrule; Sleeve for 1.5 mm ² / AWG 16; insulated; electro-tin plated; electrolytic copper; gastight crimped; acc. to DIN 46228, Part 4/09.90	www.wago.com/216-244
	Item no.: 216-262 Ferrule; Sleeve for 0.75 mm ² / AWG 20; insulated; electro-tin plated; electrolytic copper; gastight crimped; acc. to DIN 46228, Part 4/09.90	www.wago.com/216-262
	Item no.: 216-263 Ferrule; Sleeve for 1 mm ² / AWG 18; insulated; electro-tin plated; electrolytic copper; gastight crimped; acc. to DIN 46228, Part 4/09.90	www.wago.com/216-263
	Item no.: 216-264 Ferrule; Sleeve for 1.5 mm ² / AWG 16; insulated; electro-tin plated; electrolytic copper; gastight crimped; acc. to DIN 46228, Part 4/09.90	www.wago.com/216-264
	Item no.: 216-284 Ferrule; Sleeve for 1.5 mm ² / AWG 16; insulated; electro-tin plated; electrolytic copper; gastight crimped; acc. to DIN 46228, Part 4/09.90	www.wago.com/216-284
	Item no.: 216-301 Ferrule; Sleeve for 0.25 mm ² / AWG 24; insulated; electro-tin plated	www.wago.com/216-301

	Item no.: 216-302 Ferrule; Sleeve for 0.34 mm ² / AWG 24; insulated; electro-tin plated	www.wago.com/216-302
	Item no.: 216-321 Ferrule; Sleeve for 0.25 mm ² / AWG 24; insulated; electro-tin plated	www.wago.com/216-321
	Item no.: 216-322 Ferrule; Sleeve for 0.34 mm ² / AWG 24; insulated; electro-tin plated	www.wago.com/216-322

Downloads

smartDATA

CAD data

3D Download 734-324/109-000

URL

Download

Subject to changes.

WAGO Kontakttechnik GmbH & Co. KG

Hansastr. 27

32423 Minden

Phone: +49571 887-0 | Fax: +49571 887-169

Email: info.de@wago.com | Web: www.wago.com

Do you have any questions about our products?

We are always happy to take your call at +49 (571) 887-44222.