

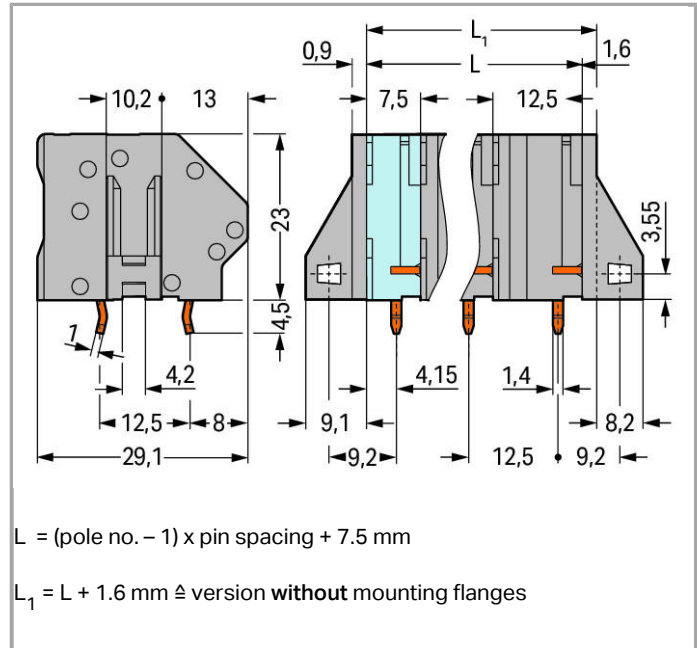

RoHS
Compliant ✓

BOMcheck.net

Color: ■



Item description

- PCB terminal strips with screwdriver-actuated CAGE CLAMP®
- Versions with Ex approval
- Unrestricted UL approval up to 600 V with 12.5 mm pin spacing
- Double solder pins for high mechanical stability
- Custom color combinations
- Integrated testing tap
- Marker slot for Mini-WSB markers

Other variants can be requested via the WAGO sales department or, if necessary, configured at <https://configurator.wago.com/>: Direct marking, Mixed-color terminal strips, Other colors, Other pole numbers, Versions for Ex e II and Ex i, Versions with mounting flanges

Data

Electrical data

Ratings per IEC/EN 60664-1

Rated voltage (III / 3)

1000 V



Rated impulse voltage (III / 3)	8 kV
Rated voltage (III / 2)	1000 V
Rated impulse voltage (III / 2)	8 kV
Rated voltage (II / 2)	1000 V
Rated impulse voltage (II / 2)	8 kV
Rated current	41 A
Legend (ratings)	(III / 2) $\hat{=}$ Overvoltage category III / Pollution degree 2

Approvals per UL 1059

Rated voltage UL (Use Group B)	600 V
Rated current UL (Use Group B)	30 A
Rated voltage UL (Use Group C)	600 V
Rated current UL (Use Group C)	30 A

Approvals per CSA

Rated voltage CSA (Use Group B)	600 V
Rated current CSA (Use Group B)	30 A
Rated voltage CSA (Use Group C)	600 V
Rated current CSA (Use Group C)	30 A

Connection data

Connection technology	CAGE CLAMP [®]
Actuation type	Operating tool
Solid conductor	0.2 ... 6 mm ² / 24 ... 10 AWG
Fine-stranded conductor	0.2 ... 6 mm ² / 24 ... 10 AWG
Fine-stranded conductor with ferrule with plastic collar	0.25 ... 4 mm ²
Fine-stranded conductor with ferrule without plastic collar	0.25 ... 4 mm ²
Strip length	11 ... 12 mm / 0.43 ... 0.47 Inch
Conductor entry angle to the PCB	45°
No. of poles	9
Total number of connection points	9
Total number of potentials	9
Number of connection types	1
Number of levels	1

Geometrical Data

Pin spacing	12.5 mm (0.492 inch)
Width	109.1 mm / 4.295 inch
Height	27.5 mm / 1.083 inch
Height from the surface	23 mm / 0.906 inch

Depth	29.1 mm / 1.146 inch
Solder pin length	4.5 mm
Solder pin dimensions	1 x 1.4 mm
Drilled hole diameter (tolerance)	1.8 ^(+0.1) mm

PCB contact

PCB contact	THT
Solder pin arrangement	over the entire terminal strip, in line
Number of solder pins per potential	2

Material Data

Color	gray
Material group	I
Insulating material	Polyamide 66 (PA 66)
Flammability class per UL94	V0
Clamping spring material	Chrome nickel spring steel (CrNi)
Contact material	Electrolytic copper (Ecu)
Contact plating	tin-plated
Fire load	1.11 MJ
Weight	57.856 g

Environmental Requirements

Limit temperature range	-60 ... +105 °C
-------------------------	-----------------

Commercial data



Country of origin	PL
GTIN	4045454625542
Customs Tariff No.	85369010000
Product Group	4 (Printed Circuit)

Approvals / Certificates

Country specific Approvals

Logo	Approval	Certificate name
	CCA DEKRA Certification B.V.	NTR NL-7097
	CCA DEKRA Certification B.V.	2160584.16

UL-Approvals











Logo	Approval	Certificate name
	cURus Underwriters Laboratories Inc.	E45172 sec6
	cURus Underwriters Laboratories Inc.	E45172 sec6



















Compatible products

tools

	Item no.: 210-721 Operating tool with partially insulated shaft; Type 3, blade (5.5 x 0.8) mm	www.wago.com/210-721
--	---	--

ferrule















	Item no.: 216-101 Ferrule; Sleeve for 0.5 mm ² / AWG 22; uninsulated; electro-tin plated	www.wago.com/216-101
	Item no.: 216-102 Ferrule; Sleeve for 0.75 mm ² / AWG 20; uninsulated; electro-tin plated	www.wago.com/216-102
	Item no.: 216-103 Ferrule; Sleeve for 1 mm ² / AWG 18; uninsulated; electro-tin plated	www.wago.com/216-103
	Item no.: 216-104 Ferrule; Sleeve for 1.5 mm ² / AWG 16; uninsulated; electro-tin plated	www.wago.com/216-104
	Item no.: 216-106 Ferrule; Sleeve for 2.5 mm ² / AWG 14; uninsulated; electro-tin plated	www.wago.com/216-106
	Item no.: 216-107 Ferrule; Sleeve for 4 mm ² / AWG 12; uninsulated; electro-tin plated	www.wago.com/216-107
	Item no.: 216-121 Ferrule; Sleeve for 0.5 mm ² / AWG 22; uninsulated; electro-tin plated	www.wago.com/216-121
	Item no.: 216-122 Ferrule; Sleeve for 0.75 mm ² / AWG 20; uninsulated; electro-tin plated	www.wago.com/216-122
	Item no.: 216-123 Ferrule; Sleeve for 1 mm ² / AWG 18; uninsulated; electro-tin plated	www.wago.com/216-123
	Item no.: 216-124 Ferrule; Sleeve for 1.5 mm ² / AWG 16; uninsulated; electro-tin plated	www.wago.com/216-124
	Item no.: 216-131 Ferrule; Sleeve for 0.25 mm ² / AWG 24; uninsulated; electro-tin plated	www.wago.com/216-131

	Item no.: 216-132 Ferrule; Sleeve for 0.34 mm ² / AWG 24; uninsulated; electro-tin plated	www.wago.com/216-132
	Item no.: 216-141 Ferrule; Sleeve for 0.5 mm ² / AWG 22; uninsulated; electro-tin plated; electrolytic copper; gastight crimped; acc. to DIN 46228, Part 1/08.92	www.wago.com/216-141
	Item no.: 216-142 Ferrule; Sleeve for 0.75 mm ² / AWG 20; uninsulated; electro-tin plated; electrolytic copper; gastight crimped; acc. to DIN 46228, Part 1/08.92	www.wago.com/216-142
	Item no.: 216-143 Ferrule; Sleeve for 1 mm ² / AWG 18; uninsulated; electro-tin plated; electrolytic copper; gastight crimped; acc. to DIN 46228, Part 1/08.92	www.wago.com/216-143
	Item no.: 216-144 Ferrule; Sleeve for 1.5 mm ² / AWG 16; uninsulated; electro-tin plated; electrolytic copper; gastight crimped; acc. to DIN 46228, Part 1/08.92	www.wago.com/216-144
	Item no.: 216-151 Ferrule; Sleeve for 0.25 mm ² / AWG 24; uninsulated; electro-tin plated	www.wago.com/216-151
	Item no.: 216-152 Ferrule; Sleeve for 0.34 mm ² / AWG 24; uninsulated; electro-tin plated	www.wago.com/216-152
	Item no.: 216-201 Ferrule; Sleeve for 0.5 mm ² / AWG 22; insulated; electro-tin plated	www.wago.com/216-201
	Item no.: 216-202 Ferrule; Sleeve for 0.75 mm ² / AWG 20; insulated; electro-tin plated	www.wago.com/216-202
	Item no.: 216-203 Ferrule; Sleeve for 1 mm ² / AWG 18; insulated; electro-tin plated	www.wago.com/216-203
	Item no.: 216-204 Ferrule; Sleeve for 1.5 mm ² / AWG 16; insulated; electro-tin plated	www.wago.com/216-204
	Item no.: 216-205 Ferrule; Sleeve for 2.08 mm ² / AWG 14; insulated; electro-tin plated	www.wago.com/216-205
	Item no.: 216-206 Ferrule; Sleeve for 2.5 mm ² / AWG 14; insulated; electro-tin plated	www.wago.com/216-206
	Item no.: 216-207 Ferrule; Sleeve for 4 mm ² / AWG 12; insulated; electro-tin plated	www.wago.com/216-207
	Item no.: 216-221 Ferrule; Sleeve for 0.5 mm ² / AWG 22; insulated; electro-tin plated	www.wago.com/216-221
	Item no.: 216-222 Ferrule; Sleeve for 0.75 mm ² / AWG 20; insulated; electro-tin plated	www.wago.com/216-222
	Item no.: 216-223 Ferrule; Sleeve for 1 mm ² / AWG 18; insulated; electro-tin plated	www.wago.com/216-223
	Item no.: 216-224 Ferrule; Sleeve for 1.5 mm ² / AWG 16; insulated; electro-tin plated	www.wago.com/216-224
	Item no.: 216-241 Ferrule; Sleeve for 0.5 mm ² / AWG 22; insulated; electro-tin plated; electrolytic copper; gastight crimped; acc. to DIN 46228, Part 4/09.90	www.wago.com/216-241
	Item no.: 216-242	

	Ferrule; Sleeve for 0.75 mm ² / AWG 20; insulated; electro-tin plated; electrolytic copper; gastight crimped; acc. to DIN 46228, Part 4/09.90	www.wago.com/216-242
	Item no.: 216-243 Ferrule; Sleeve for 1 mm ² / AWG 18; insulated; electro-tin plated; electrolytic copper; gastight crimped; acc. to DIN 46228, Part 4/09.90	www.wago.com/216-243
	Item no.: 216-244 Ferrule; Sleeve for 1.5 mm ² / AWG 16; insulated; electro-tin plated; electrolytic copper; gastight crimped; acc. to DIN 46228, Part 4/09.90	www.wago.com/216-244
	Item no.: 216-246 Ferrule; Sleeve for 2.5 mm ² / AWG 14; insulated; electro-tin plated; electrolytic copper; gastight crimped; acc. to DIN 46228, Part 4/09.90	www.wago.com/216-246
	Item no.: 216-262 Ferrule; Sleeve for 0.75 mm ² / AWG 20; insulated; electro-tin plated; electrolytic copper; gastight crimped; acc. to DIN 46228, Part 4/09.90	www.wago.com/216-262
	Item no.: 216-263 Ferrule; Sleeve for 1 mm ² / AWG 18; insulated; electro-tin plated; electrolytic copper; gastight crimped; acc. to DIN 46228, Part 4/09.90	www.wago.com/216-263
	Item no.: 216-264 Ferrule; Sleeve for 1.5 mm ² / AWG 16; insulated; electro-tin plated; electrolytic copper; gastight crimped; acc. to DIN 46228, Part 4/09.90	www.wago.com/216-264
	Item no.: 216-266 Ferrule; Sleeve for 2.5 mm ² / AWG 14; insulated; electro-tin plated; electrolytic copper; gastight crimped; acc. to DIN 46228, Part 4/09.90	www.wago.com/216-266
	Item no.: 216-267 Ferrule; Sleeve for 4 mm ² / AWG 12; insulated; electro-tin plated; electrolytic copper; gastight crimped; acc. to DIN 46228, Part 4/09.90	www.wago.com/216-267
	Item no.: 216-284 Ferrule; Sleeve for 1.5 mm ² / AWG 16; insulated; electro-tin plated; electrolytic copper; gastight crimped; acc. to DIN 46228, Part 4/09.90	www.wago.com/216-284
	Item no.: 216-286 Ferrule; Sleeve for 2.5 mm ² / AWG 14; insulated; electro-tin plated; electrolytic copper; gastight crimped; acc. to DIN 46228, Part 4/09.90	www.wago.com/216-286
	Item no.: 216-287 Ferrule; Sleeve for 4 mm ² / AWG 12; insulated; electro-tin plated; electrolytic copper; gastight crimped; acc. to DIN 46228, Part 4/09.90	www.wago.com/216-287
	Item no.: 216-301 Ferrule; Sleeve for 0.25 mm ² / AWG 24; insulated; electro-tin plated	www.wago.com/216-301
	Item no.: 216-302 Ferrule; Sleeve for 0.34 mm ² / AWG 24; insulated; electro-tin plated	www.wago.com/216-302
	Item no.: 216-321 Ferrule; Sleeve for 0.25 mm ² / AWG 24; insulated; electro-tin plated	www.wago.com/216-321
	Item no.: 216-322 Ferrule; Sleeve for 0.34 mm ² / AWG 24; insulated; electro-tin plated	www.wago.com/216-322

Marking accessories

	Item no.: 2009-115 WMB-Inline; for smartPRINTER; on reel; stretchable 5 - 5.2 mm; plain; snap-on type	www.wago.com/2009-115
--	---	--

	<p>Item no.: 2009-115/000-002 WMB-Inline; for smartPRINTER; on reel; stretchable 5 - 5.2 mm; plain; snap-on type</p>	<p>www.wago.com/2009-115/000-002</p>
	<p>Item no.: 2009-115/000-006 WMB-Inline; for smartPRINTER; on reel; stretchable 5 - 5.2 mm; plain; snap-on type</p>	<p>www.wago.com/2009-115/000-006</p>
	<p>Item no.: 2009-115/000-007 WMB-Inline; for smartPRINTER; on reel; stretchable 5 - 5.2 mm; plain; snap-on type</p>	<p>www.wago.com/2009-115/000-007</p>
	<p>Item no.: 2009-115/000-012 WMB-Inline; for smartPRINTER; on reel; stretchable 5 - 5.2 mm; plain; snap-on type</p>	<p>www.wago.com/2009-115/000-012</p>
	<p>Item no.: 2009-115/000-017 WMB-Inline; for smartPRINTER; on reel; stretchable 5 - 5.2 mm; plain; snap-on type</p>	<p>www.wago.com/2009-115/000-017</p>
	<p>Item no.: 2009-115/000-023 WMB-Inline; for smartPRINTER; on reel; stretchable 5 - 5.2 mm; plain; snap-on type</p>	<p>www.wago.com/2009-115/000-023</p>
	<p>Item no.: 2009-115/000-024 WMB-Inline; for smartPRINTER; on reel; stretchable 5 - 5.2 mm; plain; snap-on type</p>	<p>www.wago.com/2009-115/000-024</p>
	<p>Item no.: 2009-145 Mini-WSB Inline; for smartPRINTER; on reel; stretchable 5 - 5.2 mm; plain; snap-on type</p>	<p>www.wago.com/2009-145</p>
	<p>Item no.: 2009-145/000-002 Mini-WSB Inline; for smartPRINTER; on reel; stretchable 5 - 5.2 mm; plain; snap-on type</p>	<p>www.wago.com/2009-145/000-002</p>
	<p>Item no.: 2009-145/000-005 Mini-WSB Inline; for smartPRINTER; on reel; stretchable 5 - 5.2 mm; plain; snap-on type</p>	<p>www.wago.com/2009-145/000-005</p>
	<p>Item no.: 2009-145/000-006 Mini-WSB Inline; for smartPRINTER; on reel; stretchable 5 - 5.2 mm; plain; snap-on type</p>	<p>www.wago.com/2009-145/000-006</p>
	<p>Item no.: 2009-145/000-007 Mini-WSB Inline; for smartPRINTER; on reel; stretchable 5 - 5.2 mm; plain; snap-on type</p>	<p>www.wago.com/2009-145/000-007</p>
	<p>Item no.: 2009-145/000-012 Mini-WSB Inline; for smartPRINTER; on reel; stretchable 5 - 5.2 mm; plain; snap-on type</p>	<p>www.wago.com/2009-145/000-012</p>
	<p>Item no.: 2009-145/000-023 Mini-WSB Inline; for smartPRINTER; on reel; stretchable 5 - 5.2 mm; plain; snap-on type</p>	<p>www.wago.com/2009-145/000-023</p>
	<p>Item no.: 2009-145/000-024 Mini-WSB Inline; on reel; stretchable 5 - 5.2 mm; plain; snap-on type</p>	<p>www.wago.com/2009-145/000-024</p>

**Item no.: 248-501**

Miniature WSB Quick marking system; plain; Marker width 5 mm; 10 strips with 10 markers per card

www.wago.com/248-501**Item no.: 248-501/000-002**

Mini-WSB marking card; as card; not stretchable; plain; snap-on type

www.wago.com/248-501/000-002**Item no.: 248-501/000-005**

Mini-WSB marking card; as card; plain; snap-on type

www.wago.com/248-501/000-005**Item no.: 248-501/000-006**

Mini-WSB marking card; as card; not stretchable; plain; snap-on type

www.wago.com/248-501/000-006**Item no.: 248-501/000-007**

Mini-WSB marking card; as card; not stretchable; plain; snap-on type

www.wago.com/248-501/000-007**Item no.: 248-501/000-012**

Mini-WSB marking card; as card; not stretchable; plain; snap-on type

www.wago.com/248-501/000-012**Item no.: 248-501/000-017**

Mini-WSB marking card; as card; not stretchable; plain; snap-on type

www.wago.com/248-501/000-017**Item no.: 248-501/000-023**

Mini-WSB marking card; as card; not stretchable; plain; snap-on type

www.wago.com/248-501/000-023**Item no.: 248-501/000-024**

Mini-WSB marking card; as card; not stretchable; plain; snap-on type

www.wago.com/248-501/000-024**Item no.: 793-501**

WMB marking card; as card; not stretchable; plain; snap-on type

www.wago.com/793-501**Item no.: 793-501/000-002**

WMB marking card; as card; not stretchable; plain; snap-on type

www.wago.com/793-501/000-002**Item no.: 793-501/000-005**

WMB marking card; as card; not stretchable; plain; snap-on type

www.wago.com/793-501/000-005**Item no.: 793-501/000-006**

WMB marking card; as card; not stretchable; plain; snap-on type

www.wago.com/793-501/000-006**Item no.: 793-501/000-007**

WMB marking card; as card; not stretchable; plain; snap-on type

www.wago.com/793-501/000-007**Item no.: 793-501/000-012**

WMB marking card; as card; not stretchable; plain; snap-on type

www.wago.com/793-501/000-012



Item no.: 793-501/000-017
WMB marking card; as card; not stretchable; plain; snap-on type

www.wago.com/793-501/000-017



Item no.: 793-501/000-023
WMB marking card; as card; not stretchable; plain; snap-on type

www.wago.com/793-501/000-023



Item no.: 793-501/000-024
WMB marking card; as card; not stretchable; plain; snap-on type

www.wago.com/793-501/000-024



Item no.: 793-5501
WMB marking card; as card; for terminal block width 5 - 17.5 mm; stretchable 5 - 5.2 mm; plain; snap-on type

www.wago.com/793-5501



Item no.: 793-5501/000-002
WMB marking card; as card; for terminal block width 5 - 17.5 mm; stretchable 5 - 5.2 mm; plain; snap-on type

www.wago.com/793-5501/000-002



Item no.: 793-5501/000-005
WMB marking card; as card; stretchable 5 - 5.2 mm; plain; snap-on type

www.wago.com/793-5501/000-005



Item no.: 793-5501/000-006
WMB marking card; as card; stretchable 5 - 5.2 mm; plain; snap-on type

www.wago.com/793-5501/000-006



Item no.: 793-5501/000-007
WMB marking card; as card; stretchable 5 - 5.2 mm; plain; snap-on type

www.wago.com/793-5501/000-007



Item no.: 793-5501/000-012
WMB marking card; as card; stretchable 5 - 5.2 mm; plain; snap-on type

www.wago.com/793-5501/000-012



Item no.: 793-5501/000-017
WMB marking card; as card; stretchable 5 - 5.2 mm; plain; snap-on type

www.wago.com/793-5501/000-017



Item no.: 793-5501/000-023
WMB marking card; as card; stretchable 5 - 5.2 mm; plain; snap-on type

www.wago.com/793-5501/000-023



Item no.: 793-5501/000-024
WMB marking card; as card; stretchable 5 - 5.2 mm; plain; snap-on type

www.wago.com/793-5501/000-024

check



Item no.: 210-136
Test plug; 2 mm Ø; with 500 mm cable

www.wago.com/210-136



Item no.: 210-137
Test plug; 2.3 mm Ø; with 500 mm cable

www.wago.com/210-137



Downloads

smartDATA

CAD data

3D Download 745-1409		URL	Download
PCB libraries			
TARGET Library for WAGO PCB Terminal Blocks Compatible with TARGET PCB Design Software Version 17.x	1.1.0 Oct 6, 2014	ZIP 27.1 MB	Download
EAGLE Library for WAGO PCB Terminal Blocks Compatible with EAGLE PCB Design Software Version 6.x or higher	2.1 Nov 17, 2017	ZIP 23.9 MB	Download
DesignSpark Library for WAGO PCB Terminal Blocks Compatible with DesignSpark PCB Version 4.x or higher	2.1 Oct 6, 2014	ZIP 22.5 MB	Download

Subject to changes.