

## Data sheet | Item number: 745-362

PCB terminal block; 6 mm<sup>2</sup>; Pin spacing 10 mm; 12-pole; CAGE CLAMP®; commoning option

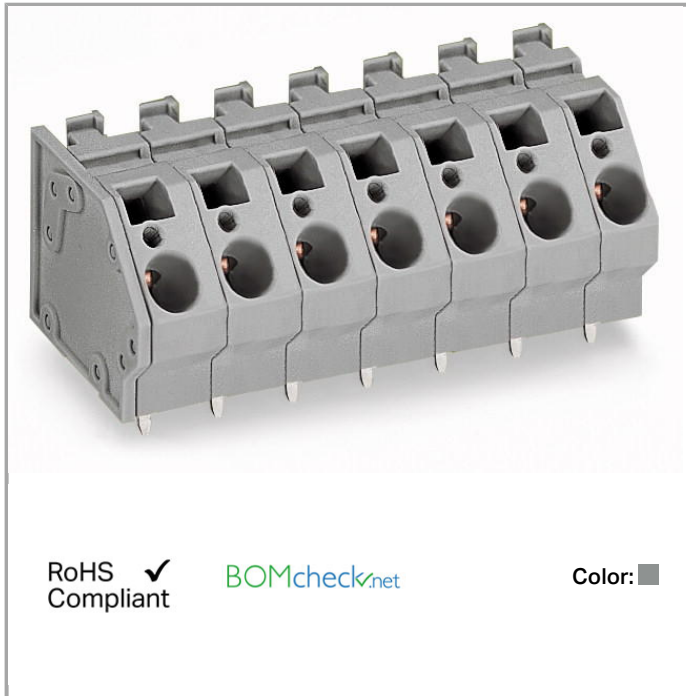

[www.wago.com/745-362](http://www.wago.com/745-362)



RoHS  Compliant

BOMcheck.net

Color: ■

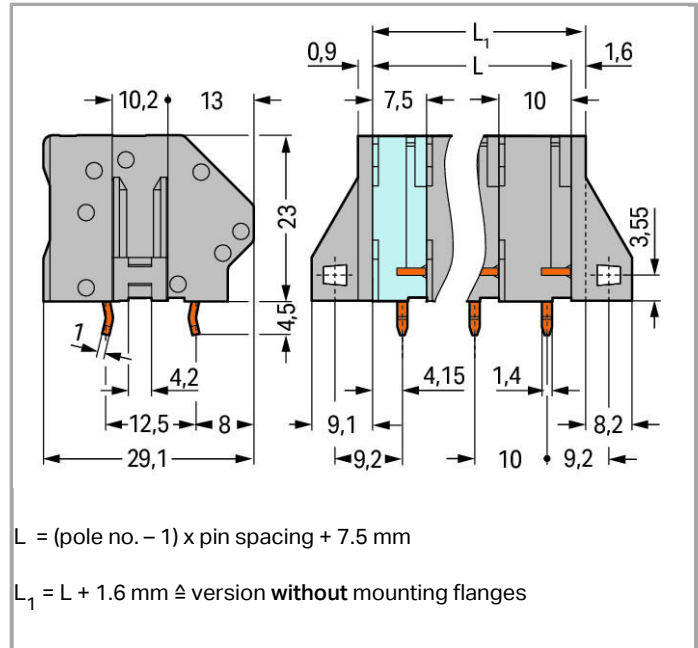

### Item description

- PCB terminal strips with screwdriver-actuated CAGE CLAMP®
- Versions with Ex approval
- Common and distribute potentials via comb-style jumper bars
- Double solder pins for high mechanical stability
- Custom color combinations
- Integrated testing tap
- Marker slot for Mini-WSB markers

Other variants can be requested via the WAGO sales department or, if necessary, configured at <https://configurator.wago.com/>: Direct marking, Mixed-color terminal strips, Other colors, Other pole numbers, Versions for Ex e II and Ex i, Versions with mounting flanges

### Data

#### Electrical data

#### Ratings per IEC/EN 60664-1

|                                 |       |
|---------------------------------|-------|
| Rated voltage (III / 3)         | 630 V |
| Rated impulse voltage (III / 3) | 8 kV  |



|                                 |   |
|---------------------------------|---|
| Rated voltage (III / 2)         | 1000 V  |
| Rated impulse voltage (III / 2) | 8 kV  |
| Rated voltage (II / 2)          | 1000 V  |
| Rated impulse voltage (II / 2)  | 8 kV  |
| Rated current                   | 41 A  |
| Legend (ratings)                | (III / 2) ≙ Overvoltage category III / Pollution degree 2 |

### Approvals per UL 1059

|                                |       |
|--------------------------------|-------|
| Rated voltage UL (Use Group B) | 300 V |
| Rated current UL (Use Group B) | 30 A  |
| Rated voltage UL (Use Group C) | 150 V |
| Rated current UL (Use Group C) | 30 A  |
| Rated voltage UL (Use Group D) | 300 V |
| Rated current UL (Use Group D) | 10 A  |

### Approvals per CSA

|                                 |       |
|---------------------------------|-------|
| Rated voltage CSA (Use Group B) | 300 V |
| Rated current CSA (Use Group B) | 30 A  |
| Rated voltage CSA (Use Group C) | 150 V |
| Rated current CSA (Use Group C) | 30 A  |
| Rated voltage CSA (Use Group D) | 300 V |
| Rated current CSA (Use Group D) | 10 A  |

### Connection data

|   |   |
|---|---|
| Connection technology                                       | CAGE CLAMP®                               |
| Actuation type  | Operating tool                            |
| Solid conductor   | 0.2 ... 6 mm <sup>2</sup> / 24 ... 10 AWG |
| Fine-stranded conductor                                     | 0.2 ... 6 mm <sup>2</sup> / 24 ... 10 AWG |
| Fine-stranded conductor with ferrule with plastic collar    | 0.25 ... 4 mm <sup>2</sup>                |
| Fine-stranded conductor with ferrule without plastic collar | 0.25 ... 4 mm <sup>2</sup>                |
| Strip length  | 11 ... 12 mm / 0.43 ... 0.47 Inch         |
| Conductor entry angle to the PCB                            | 45°                                       |
| No. of poles  | 12  |
| Total number of connection points                           | 12  |
| Total number of potentials                                  | 12  |
| Number of connection types                                  | 1   |
| Number of levels  | 1   |
| Number of jumper slots                                      | 1   |



## Geometrical Data

|                                   |                          |
|-----------------------------------|--------------------------|
| Pin spacing                       | 10 mm (0.394 inch)       |
| Width                             | 119.1 mm / 4.689 inch    |
| Height                            | 27.5 mm / 1.083 inch     |
| Height from the surface           | 23 mm / 0.906 inch       |
| Depth                             | 29.1 mm / 1.146 inch     |
| Solder pin length                 | 4.5 mm                   |
| Solder pin dimensions             | 1 x 1.4 mm               |
| Drilled hole diameter (tolerance) | 1.8 <sup>(+0.1)</sup> mm |

## PCB contact

|                                     |   |
|-------------------------------------|---|
| PCB contact                         | THT                                     |
| Solder pin arrangement              | over the entire terminal strip, in line |
| Number of solder pins per potential | 2                                       |

## Material Data

|                             |                                   |
|-----------------------------|-----------------------------------|
| Color                       | gray                              |
| Material group              | I                                 |
| Insulating material         | Polyamide 66 (PA 66)              |
| Flammability class per UL94 | V0                                |
| Clamping spring material    | Chrome nickel spring steel (CrNi) |
| Contact material            | Electrolytic copper (Ecu)         |
| Contact plating             | tin-plated                        |
| Fire load                   | 1.172 MJ                          |
| Weight                      | 64.991 g                          |

## Environmental Requirements

|                         |                 |
|-------------------------|-----------------|
| Limit temperature range | -60 ... +105 °C |
|-------------------------|-----------------|

## Commercial data

|                    |                     |
|--------------------|---------------------|
| Country of origin  | PL                  |
| GTIN               | 4044918302586       |
| Customs Tariff No. | 85369010000         |
| Product Group      | 4 (Printed Circuit) |

## Approvals / Certificates

### Country specific Approvals

| Logo | Approval | Certificate name |
|------|----------|------------------|
|      |          |                  |



CCA  
DEKRA Certification B.V.

NTR NL-7097



CCA  
DEKRA Certification B.V.

2160584.16

























CSA  
DEKRA Certification B.V.















1604421

## Compatible products

### ferrule

|  |  |  |
|--|--|--|
|    | <b>Item no.: 216-101</b><br>Ferrule; Sleeve for 0.5 mm <sup>2</sup> / AWG 22; uninsulated; electro-tin plated  | <a href="http://www.wago.com/216-101">www.wago.com/216-101</a> |
|    | <b>Item no.: 216-102</b><br>Ferrule; Sleeve for 0.75 mm <sup>2</sup> / AWG 20; uninsulated; electro-tin plated | <a href="http://www.wago.com/216-102">www.wago.com/216-102</a> |
|   | <b>Item no.: 216-103</b><br>Ferrule; Sleeve for 1 mm <sup>2</sup> / AWG 18; uninsulated; electro-tin plated    | <a href="http://www.wago.com/216-103">www.wago.com/216-103</a> |
|  | <b>Item no.: 216-104</b><br>Ferrule; Sleeve for 1.5 mm <sup>2</sup> / AWG 16; uninsulated; electro-tin plated  | <a href="http://www.wago.com/216-104">www.wago.com/216-104</a> |
|  | <b>Item no.: 216-106</b><br>Ferrule; Sleeve for 2.5 mm <sup>2</sup> / AWG 14; uninsulated; electro-tin plated  | <a href="http://www.wago.com/216-106">www.wago.com/216-106</a> |
|  | <b>Item no.: 216-107</b><br>Ferrule; Sleeve for 4 mm <sup>2</sup> / AWG 12; uninsulated; electro-tin plated    | <a href="http://www.wago.com/216-107">www.wago.com/216-107</a> |
|  | <b>Item no.: 216-108</b><br>Ferrule; Sleeve for 6 mm <sup>2</sup> / AWG 10; uninsulated; electro-tin plated    | <a href="http://www.wago.com/216-108">www.wago.com/216-108</a> |
|  | <b>Item no.: 216-109</b><br>Ferrule; Sleeve for 10 mm <sup>2</sup> / AWG 8; uninsulated; electro-tin plated    | <a href="http://www.wago.com/216-109">www.wago.com/216-109</a> |
|  | <b>Item no.: 216-110</b><br>Ferrule; Sleeve for 16 mm <sup>2</sup> / AWG 6; uninsulated; electro-tin plated    | <a href="http://www.wago.com/216-110">www.wago.com/216-110</a> |
|  | <b>Item no.: 216-121</b><br>Ferrule; Sleeve for 0.5 mm <sup>2</sup> / AWG 22; uninsulated; electro-tin plated  | <a href="http://www.wago.com/216-121">www.wago.com/216-121</a> |
|  | <b>Item no.: 216-122</b><br>Ferrule; Sleeve for 0.75 mm <sup>2</sup> / AWG 20; uninsulated; electro-tin plated | <a href="http://www.wago.com/216-122">www.wago.com/216-122</a> |
|  | <b>Item no.: 216-123</b><br>Ferrule; Sleeve for 1 mm <sup>2</sup> / AWG 18; uninsulated; electro-tin plated    | <a href="http://www.wago.com/216-123">www.wago.com/216-123</a> |
|  | <b>Item no.: 216-124</b><br>Ferrule; Sleeve for 1.5 mm <sup>2</sup> / AWG 16; uninsulated; electro-tin plated  | <a href="http://www.wago.com/216-124">www.wago.com/216-124</a> |

|   |  |  |
|---|--|--|
|    | <b>Item no.: 216-131</b><br>Ferrule; Sleeve for 0.25 mm <sup>2</sup> / AWG 24; uninsulated; electro-tin plated   | <a href="http://www.wago.com/216-131">www.wago.com/216-131</a> |
|    | <b>Item no.: 216-132</b><br>Ferrule; Sleeve for 0.34 mm <sup>2</sup> / AWG 24; uninsulated; electro-tin plated   | <a href="http://www.wago.com/216-132">www.wago.com/216-132</a> |
|    | <b>Item no.: 216-141</b><br>Ferrule; Sleeve for 0.5 mm <sup>2</sup> / AWG 22; uninsulated; electro-tin plated; electrolytic copper; gastight crimped; acc. to DIN 46228, Part 1/08.92  | <a href="http://www.wago.com/216-141">www.wago.com/216-141</a> |
|    | <b>Item no.: 216-142</b><br>Ferrule; Sleeve for 0.75 mm <sup>2</sup> / AWG 20; uninsulated; electro-tin plated; electrolytic copper; gastight crimped; acc. to DIN 46228, Part 1/08.92 | <a href="http://www.wago.com/216-142">www.wago.com/216-142</a> |
|    | <b>Item no.: 216-143</b><br>Ferrule; Sleeve for 1 mm <sup>2</sup> / AWG 18; uninsulated; electro-tin plated; electrolytic copper; gastight crimped; acc. to DIN 46228, Part 1/08.92    | <a href="http://www.wago.com/216-143">www.wago.com/216-143</a> |
|    | <b>Item no.: 216-144</b><br>Ferrule; Sleeve for 1.5 mm <sup>2</sup> / AWG 16; uninsulated; electro-tin plated; electrolytic copper; gastight crimped; acc. to DIN 46228, Part 1/08.92  | <a href="http://www.wago.com/216-144">www.wago.com/216-144</a> |
|    | <b>Item no.: 216-151</b><br>Ferrule; Sleeve for 0.25 mm <sup>2</sup> / AWG 24; uninsulated; electro-tin plated   | <a href="http://www.wago.com/216-151">www.wago.com/216-151</a> |
|    | <b>Item no.: 216-152</b><br>Ferrule; Sleeve for 0.34 mm <sup>2</sup> / AWG 24; uninsulated; electro-tin plated   | <a href="http://www.wago.com/216-152">www.wago.com/216-152</a> |
|    | <b>Item no.: 216-201</b><br>Ferrule; Sleeve for 0.5 mm <sup>2</sup> / AWG 22; insulated; electro-tin plated  | <a href="http://www.wago.com/216-201">www.wago.com/216-201</a> |
|   | <b>Item no.: 216-202</b><br>Ferrule; Sleeve for 0.75 mm <sup>2</sup> / AWG 20; insulated; electro-tin plated   | <a href="http://www.wago.com/216-202">www.wago.com/216-202</a> |
|  | <b>Item no.: 216-203</b><br>Ferrule; Sleeve for 1 mm <sup>2</sup> / AWG 18; insulated; electro-tin plated  | <a href="http://www.wago.com/216-203">www.wago.com/216-203</a> |
|  | <b>Item no.: 216-204</b><br>Ferrule; Sleeve for 1.5 mm <sup>2</sup> / AWG 16; insulated; electro-tin plated  | <a href="http://www.wago.com/216-204">www.wago.com/216-204</a> |
|  | <b>Item no.: 216-205</b><br>Ferrule; Sleeve for 2.08 mm <sup>2</sup> / AWG 14; insulated; electro-tin plated   | <a href="http://www.wago.com/216-205">www.wago.com/216-205</a> |
|  | <b>Item no.: 216-206</b><br>Ferrule; Sleeve for 2.5 mm <sup>2</sup> / AWG 14; insulated; electro-tin plated  | <a href="http://www.wago.com/216-206">www.wago.com/216-206</a> |
|  | <b>Item no.: 216-207</b><br>Ferrule; Sleeve for 4 mm <sup>2</sup> / AWG 12; insulated; electro-tin plated  | <a href="http://www.wago.com/216-207">www.wago.com/216-207</a> |
|  | <b>Item no.: 216-208</b><br>Ferrule; Sleeve for 6 mm <sup>2</sup> / AWG 10; insulated; electro-tin plated; electrolytic copper; gastight crimped; acc. to DIN 46228, Part 4/09.90      | <a href="http://www.wago.com/216-208">www.wago.com/216-208</a> |
|  | <b>Item no.: 216-209</b><br>Ferrule; Sleeve for 10 mm <sup>2</sup> / AWG 8; insulated; electro-tin plated  | <a href="http://www.wago.com/216-209">www.wago.com/216-209</a> |
|  | <b>Item no.: 216-210</b><br>Ferrule; Sleeve for 16 mm <sup>2</sup> / AWG 6; insulated; electro-tin plated; electrolytic copper; gastight crimped; acc. to DIN 46228, Part 4/09.90      | <a href="http://www.wago.com/216-210">www.wago.com/216-210</a> |
|  | <b>Item no.: 216-221</b><br>Ferrule; Sleeve for 0.5 mm <sup>2</sup> / AWG 22; insulated; electro-tin plated  | <a href="http://www.wago.com/216-221">www.wago.com/216-221</a> |

|   |  |  |
|---|--|--|
|    | <b>Item no.: 216-222</b><br>Ferrule; Sleeve for 0.75 mm <sup>2</sup> / AWG 20; insulated; electro-tin plated   | <a href="http://www.wago.com/216-222">www.wago.com/216-222</a> |
|    | <b>Item no.: 216-223</b><br>Ferrule; Sleeve for 1 mm <sup>2</sup> / AWG 18; insulated; electro-tin plated  | <a href="http://www.wago.com/216-223">www.wago.com/216-223</a> |
|    | <b>Item no.: 216-224</b><br>Ferrule; Sleeve for 1.5 mm <sup>2</sup> / AWG 16; insulated; electro-tin plated  | <a href="http://www.wago.com/216-224">www.wago.com/216-224</a> |
|    | <b>Item no.: 216-241</b><br>Ferrule; Sleeve for 0.5 mm <sup>2</sup> / AWG 22; insulated; electro-tin plated; electrolytic copper; gastight crimped; acc. to DIN 46228, Part 4/09.90  | <a href="http://www.wago.com/216-241">www.wago.com/216-241</a> |
|    | <b>Item no.: 216-242</b><br>Ferrule; Sleeve for 0.75 mm <sup>2</sup> / AWG 20; insulated; electro-tin plated; electrolytic copper; gastight crimped; acc. to DIN 46228, Part 4/09.90 | <a href="http://www.wago.com/216-242">www.wago.com/216-242</a> |
|    | <b>Item no.: 216-243</b><br>Ferrule; Sleeve for 1 mm <sup>2</sup> / AWG 18; insulated; electro-tin plated; electrolytic copper; gastight crimped; acc. to DIN 46228, Part 4/09.90    | <a href="http://www.wago.com/216-243">www.wago.com/216-243</a> |
|    | <b>Item no.: 216-244</b><br>Ferrule; Sleeve for 1.5 mm <sup>2</sup> / AWG 16; insulated; electro-tin plated; electrolytic copper; gastight crimped; acc. to DIN 46228, Part 4/09.90  | <a href="http://www.wago.com/216-244">www.wago.com/216-244</a> |
|    | <b>Item no.: 216-246</b><br>Ferrule; Sleeve for 2.5 mm <sup>2</sup> / AWG 14; insulated; electro-tin plated; electrolytic copper; gastight crimped; acc. to DIN 46228, Part 4/09.90  | <a href="http://www.wago.com/216-246">www.wago.com/216-246</a> |
|    | <b>Item no.: 216-262</b><br>Ferrule; Sleeve for 0.75 mm <sup>2</sup> / AWG 20; insulated; electro-tin plated; electrolytic copper; gastight crimped; acc. to DIN 46228, Part 4/09.90 | <a href="http://www.wago.com/216-262">www.wago.com/216-262</a> |
|   | <b>Item no.: 216-263</b><br>Ferrule; Sleeve for 1 mm <sup>2</sup> / AWG 18; insulated; electro-tin plated; electrolytic copper; gastight crimped; acc. to DIN 46228, Part 4/09.90    | <a href="http://www.wago.com/216-263">www.wago.com/216-263</a> |
|  | <b>Item no.: 216-264</b><br>Ferrule; Sleeve for 1.5 mm <sup>2</sup> / AWG 16; insulated; electro-tin plated; electrolytic copper; gastight crimped; acc. to DIN 46228, Part 4/09.90  | <a href="http://www.wago.com/216-264">www.wago.com/216-264</a> |
|  | <b>Item no.: 216-266</b><br>Ferrule; Sleeve for 2.5 mm <sup>2</sup> / AWG 14; insulated; electro-tin plated; electrolytic copper; gastight crimped; acc. to DIN 46228, Part 4/09.90  | <a href="http://www.wago.com/216-266">www.wago.com/216-266</a> |
|  | <b>Item no.: 216-267</b><br>Ferrule; Sleeve for 4 mm <sup>2</sup> / AWG 12; insulated; electro-tin plated; electrolytic copper; gastight crimped; acc. to DIN 46228, Part 4/09.90    | <a href="http://www.wago.com/216-267">www.wago.com/216-267</a> |
|  | <b>Item no.: 216-284</b><br>Ferrule; Sleeve for 1.5 mm <sup>2</sup> / AWG 16; insulated; electro-tin plated; electrolytic copper; gastight crimped; acc. to DIN 46228, Part 4/09.90  | <a href="http://www.wago.com/216-284">www.wago.com/216-284</a> |
|  | <b>Item no.: 216-286</b><br>Ferrule; Sleeve for 2.5 mm <sup>2</sup> / AWG 14; insulated; electro-tin plated; electrolytic copper; gastight crimped; acc. to DIN 46228, Part 4/09.90  | <a href="http://www.wago.com/216-286">www.wago.com/216-286</a> |
|  | <b>Item no.: 216-287</b><br>Ferrule; Sleeve for 4 mm <sup>2</sup> / AWG 12; insulated; electro-tin plated; electrolytic copper; gastight crimped; acc. to DIN 46228, Part 4/09.90    | <a href="http://www.wago.com/216-287">www.wago.com/216-287</a> |
|  | <b>Item no.: 216-288</b><br>Ferrule; Sleeve for 6 mm <sup>2</sup> / AWG 10; insulated; electro-tin plated; electrolytic copper; gastight crimped; acc. to DIN 46228, Part 4/09.90    | <a href="http://www.wago.com/216-288">www.wago.com/216-288</a> |
|   | <b>Item no.: 216-289</b><br>Ferrule; Sleeve for 10 mm <sup>2</sup> / AWG 8; insulated; electro-tin plated; electrolytic copper; gastight crimped;                                    | <a href="http://www.wago.com/216-289">www.wago.com/216-289</a> |



acc. to DIN 46228, Part 4/09.90

**Item no.: 216-301**Ferrule; Sleeve for 0.25 mm<sup>2</sup> / AWG 24; insulated; electro-tin plated[www.wago.com/216-301](http://www.wago.com/216-301)**Item no.: 216-302**Ferrule; Sleeve for 0.34 mm<sup>2</sup> / AWG 24; insulated; electro-tin plated[www.wago.com/216-302](http://www.wago.com/216-302)**Item no.: 216-321**Ferrule; Sleeve for 0.25 mm<sup>2</sup> / AWG 24; insulated; electro-tin plated[www.wago.com/216-321](http://www.wago.com/216-321)**Item no.: 216-322**Ferrule; Sleeve for 0.34 mm<sup>2</sup> / AWG 24; insulated; electro-tin plated[www.wago.com/216-322](http://www.wago.com/216-322)**Marking accessories****Item no.: 2009-115**

WMB-Inline; for smartPRINTER; on reel; stretchable 5 - 5.2 mm; plain; snap-on type

[www.wago.com/2009-115](http://www.wago.com/2009-115)**Item no.: 2009-115/000-002**

WMB-Inline; for smartPRINTER; on reel; stretchable 5 - 5.2 mm; plain; snap-on type

[www.wago.com/2009-115/000-002](http://www.wago.com/2009-115/000-002)**Item no.: 2009-115/000-006**

WMB-Inline; for smartPRINTER; on reel; stretchable 5 - 5.2 mm; plain; snap-on type

[www.wago.com/2009-115/000-006](http://www.wago.com/2009-115/000-006)**Item no.: 2009-115/000-007**

WMB-Inline; for smartPRINTER; on reel; stretchable 5 - 5.2 mm; plain; snap-on type

[www.wago.com/2009-115/000-007](http://www.wago.com/2009-115/000-007)**Item no.: 2009-115/000-012**

WMB-Inline; for smartPRINTER; on reel; stretchable 5 - 5.2 mm; plain; snap-on type

[www.wago.com/2009-115/000-012](http://www.wago.com/2009-115/000-012)**Item no.: 2009-115/000-017**

WMB-Inline; for smartPRINTER; on reel; stretchable 5 - 5.2 mm; plain; snap-on type

[www.wago.com/2009-115/000-017](http://www.wago.com/2009-115/000-017)**Item no.: 2009-115/000-023**

WMB-Inline; for smartPRINTER; on reel; stretchable 5 - 5.2 mm; plain; snap-on type

[www.wago.com/2009-115/000-023](http://www.wago.com/2009-115/000-023)**Item no.: 2009-115/000-024**

WMB-Inline; for smartPRINTER; on reel; stretchable 5 - 5.2 mm; plain; snap-on type

[www.wago.com/2009-115/000-024](http://www.wago.com/2009-115/000-024)**Item no.: 2009-145**

Mini-WSB Inline; for smartPRINTER; on reel; stretchable 5 - 5.2 mm; plain; snap-on type















[www.wago.com/2009-145](http://www.wago.com/2009-145)**Item no.: 2009-145/000-002**

Mini-WSB Inline; for smartPRINTER; on reel; stretchable 5 - 5.2 mm; plain; snap-on type

[www.wago.com/2009-145/000-002](http://www.wago.com/2009-145/000-002)**Item no.: 2009-145/000-005**

Mini-WSB Inline; for smartPRINTER; on reel; stretchable 5 - 5.2 mm; plain; snap-on type

[www.wago.com/2009-145/000-005](http://www.wago.com/2009-145/000-005)

|  |   |   |
|--|---|---|
|    | <p><b>Item no.: 2009-145/000-006</b><br/>                 Mini-WSB Inline; for smartPRINTER; on reel; stretchable 5 - 5.2 mm; plain; snap-on type</p> | <p><a href="http://www.wago.com/2009-145/000-006">www.wago.com/2009-145/000-006</a></p> |
|    | <p><b>Item no.: 2009-145/000-007</b><br/>                 Mini-WSB Inline; for smartPRINTER; on reel; stretchable 5 - 5.2 mm; plain; snap-on type</p> | <p><a href="http://www.wago.com/2009-145/000-007">www.wago.com/2009-145/000-007</a></p> |
|    | <p><b>Item no.: 2009-145/000-012</b><br/>                 Mini-WSB Inline; for smartPRINTER; on reel; stretchable 5 - 5.2 mm; plain; snap-on type</p> | <p><a href="http://www.wago.com/2009-145/000-012">www.wago.com/2009-145/000-012</a></p> |
|    | <p><b>Item no.: 2009-145/000-023</b><br/>                 Mini-WSB Inline; for smartPRINTER; on reel; stretchable 5 - 5.2 mm; plain; snap-on type</p> | <p><a href="http://www.wago.com/2009-145/000-023">www.wago.com/2009-145/000-023</a></p> |
|    | <p><b>Item no.: 2009-145/000-024</b><br/>                 Mini-WSB Inline; on reel; stretchable 5 - 5.2 mm; plain; snap-on type</p>                   | <p><a href="http://www.wago.com/2009-145/000-024">www.wago.com/2009-145/000-024</a></p> |
|    | <p><b>Item no.: 248-501</b><br/>                 Miniature WSB Quick marking system; plain; Marker width 5 mm; 10 strips with 10 markers per card</p> | <p><a href="http://www.wago.com/248-501">www.wago.com/248-501</a></p>                   |
|    | <p><b>Item no.: 248-501/000-002</b><br/>                 Mini-WSB marking card; as card; not stretchable; plain; snap-on type</p>                     | <p><a href="http://www.wago.com/248-501/000-002">www.wago.com/248-501/000-002</a></p>   |
|  | <p><b>Item no.: 248-501/000-005</b><br/>                 Mini-WSB marking card; as card; plain; snap-on type</p>                                      | <p><a href="http://www.wago.com/248-501/000-005">www.wago.com/248-501/000-005</a></p>   |
|  | <p><b>Item no.: 248-501/000-006</b><br/>                 Mini-WSB marking card; as card; not stretchable; plain; snap-on type</p>                     | <p><a href="http://www.wago.com/248-501/000-006">www.wago.com/248-501/000-006</a></p>   |
|  | <p><b>Item no.: 248-501/000-007</b><br/>                 Mini-WSB marking card; as card; not stretchable; plain; snap-on type</p>                     | <p><a href="http://www.wago.com/248-501/000-007">www.wago.com/248-501/000-007</a></p>   |
|  | <p><b>Item no.: 248-501/000-012</b><br/>                 Mini-WSB marking card; as card; not stretchable; plain; snap-on type</p>                     | <p><a href="http://www.wago.com/248-501/000-012">www.wago.com/248-501/000-012</a></p>   |
|  | <p><b>Item no.: 248-501/000-017</b><br/>                 Mini-WSB marking card; as card; not stretchable; plain; snap-on type</p>                     | <p><a href="http://www.wago.com/248-501/000-017">www.wago.com/248-501/000-017</a></p>   |
|  | <p><b>Item no.: 248-501/000-023</b><br/>                 Mini-WSB marking card; as card; not stretchable; plain; snap-on type</p>                     | <p><a href="http://www.wago.com/248-501/000-023">www.wago.com/248-501/000-023</a></p>   |
|  | <p><b>Item no.: 248-501/000-024</b><br/>                 Mini-WSB marking card; as card; not stretchable; plain; snap-on type</p>                     | <p><a href="http://www.wago.com/248-501/000-024">www.wago.com/248-501/000-024</a></p>   |
|  | <p><b>Item no.: 793-501</b><br/>                 WMB marking card; as card; not stretchable; plain; snap-on type</p>                                  | <p><a href="http://www.wago.com/793-501">www.wago.com/793-501</a></p>                   |





**Item no.: 793-501/000-002**  
WMB marking card; as card; not stretchable; plain; snap-on type

[www.wago.com/793-501/000-002](http://www.wago.com/793-501/000-002)



**Item no.: 793-501/000-005**  
WMB marking card; as card; not stretchable; plain; snap-on type

[www.wago.com/793-501/000-005](http://www.wago.com/793-501/000-005)



**Item no.: 793-501/000-006**  
WMB marking card; as card; not stretchable; plain; snap-on type

[www.wago.com/793-501/000-006](http://www.wago.com/793-501/000-006)



**Item no.: 793-501/000-007**  
WMB marking card; as card; not stretchable; plain; snap-on type

[www.wago.com/793-501/000-007](http://www.wago.com/793-501/000-007)



**Item no.: 793-501/000-012**  
WMB marking card; as card; not stretchable; plain; snap-on type

[www.wago.com/793-501/000-012](http://www.wago.com/793-501/000-012)



**Item no.: 793-501/000-017**  
WMB marking card; as card; not stretchable; plain; snap-on type

[www.wago.com/793-501/000-017](http://www.wago.com/793-501/000-017)



**Item no.: 793-501/000-023**  
WMB marking card; as card; not stretchable; plain; snap-on type

[www.wago.com/793-501/000-023](http://www.wago.com/793-501/000-023)



**Item no.: 793-501/000-024**  
WMB marking card; as card; not stretchable; plain; snap-on type

[www.wago.com/793-501/000-024](http://www.wago.com/793-501/000-024)



**Item no.: 793-5501**  
WMB marking card; as card; for terminal block width 5 - 17.5 mm; stretchable 5 - 5.2 mm; plain; snap-on type [www.wago.com/793-5501](http://www.wago.com/793-5501)



**Item no.: 793-5501/000-002**  
WMB marking card; as card; for terminal block width 5 - 17.5 mm; stretchable 5 - 5.2 mm; plain; snap-on type [www.wago.com/793-5501/000-002](http://www.wago.com/793-5501/000-002)



**Item no.: 793-5501/000-005**  
WMB marking card; as card; stretchable 5 - 5.2 mm; plain; snap-on type

[www.wago.com/793-5501/000-005](http://www.wago.com/793-5501/000-005)



**Item no.: 793-5501/000-006**  
WMB marking card; as card; stretchable 5 - 5.2 mm; plain; snap-on type

[www.wago.com/793-5501/000-006](http://www.wago.com/793-5501/000-006)



**Item no.: 793-5501/000-007**  
WMB marking card; as card; stretchable 5 - 5.2 mm; plain; snap-on type

[www.wago.com/793-5501/000-007](http://www.wago.com/793-5501/000-007)



**Item no.: 793-5501/000-012**  
WMB marking card; as card; stretchable 5 - 5.2 mm; plain; snap-on type

[www.wago.com/793-5501/000-012](http://www.wago.com/793-5501/000-012)



**Item no.: 793-5501/000-017**  
WMB marking card; as card; stretchable 5 - 5.2 mm; plain; snap-on type

[www.wago.com/793-5501/000-017](http://www.wago.com/793-5501/000-017)



**Item no.: 793-5501/000-023**  
WMB marking card; as card; stretchable 5 - 5.2 mm; plain; snap-on type

[www.wago.com/793-5501/000-023](http://www.wago.com/793-5501/000-023)



**Item no.: 793-5501/000-024**  
WMB marking card; as card; stretchable 5 - 5.2 mm; plain; snap-on type

[www.wago.com/793-5501/000-024](http://www.wago.com/793-5501/000-024)

### Jumper



**Item no.: 745-390**  
Comb-style jumper bar

[www.wago.com/745-390](http://www.wago.com/745-390)



**Item no.: 745-391**  
Comb-style jumper bar; from 1 to 3

[www.wago.com/745-391](http://www.wago.com/745-391)



**Item no.: 745-392**  
Comb-style jumper bar; 2-way

[www.wago.com/745-392](http://www.wago.com/745-392)



**Item no.: 745-393**  
Comb-style jumper bar; 3-way

[www.wago.com/745-393](http://www.wago.com/745-393)



**Item no.: 745-394**  
Comb-style jumper bar; 4-way

[www.wago.com/745-394](http://www.wago.com/745-394)



**Item no.: 745-395**  
Comb-style jumper bar; 5-way

[www.wago.com/745-395](http://www.wago.com/745-395)

### check



**Item no.: 210-136**  
Test plug; 2 mm Ø; with 500 mm cable

[www.wago.com/210-136](http://www.wago.com/210-136)



**Item no.: 210-137**  
Test plug; 2.3 mm Ø; with 500 mm cable

[www.wago.com/210-137](http://www.wago.com/210-137)

### Downloads

#### smartDATA

#### CAD data

3D Download 745-362

[URL](#) [Download](#)

#### PCB libraries

DesignSpark Library for WAGO PCB Terminal Blocks  
Compatible with DesignSpark PCB Version 4.x or higher

2.1  
Oct 6, 2014

ZIP  
22.5 MB

[Download](#)

TARGET Library for WAGO PCB Terminal Blocks  
Compatible with TARGET PCB Design Software Version 17.x

1.1.0  
Oct 6, 2014

ZIP  
27.1 MB

[Download](#)

EAGLE Library for WAGO PCB Terminal Blocks  
Compatible with EAGLE PCB Design Software Version 6.x or higher

2.1  
Nov 17, 2017

ZIP  
23.9 MB

[Download](#)



Subject to changes.

---

WAGO Kontakttechnik GmbH & Co. KG  
Hansastr. 27  
32423 Minden  
Phone: +49571 887-0 | Fax: +49571 887-169  
Email: [info.de@wago.com](mailto:info.de@wago.com) | Web: [www.wago.com](http://www.wago.com)

Do you have any questions about our products?  
We are always happy to take your call at +49 (571) 887-44222.