

Data sheet | Item number: 757-363

M8 sensor/actuator box; 6-way; 3-pole; M16 connector

www.wago.com/757-363

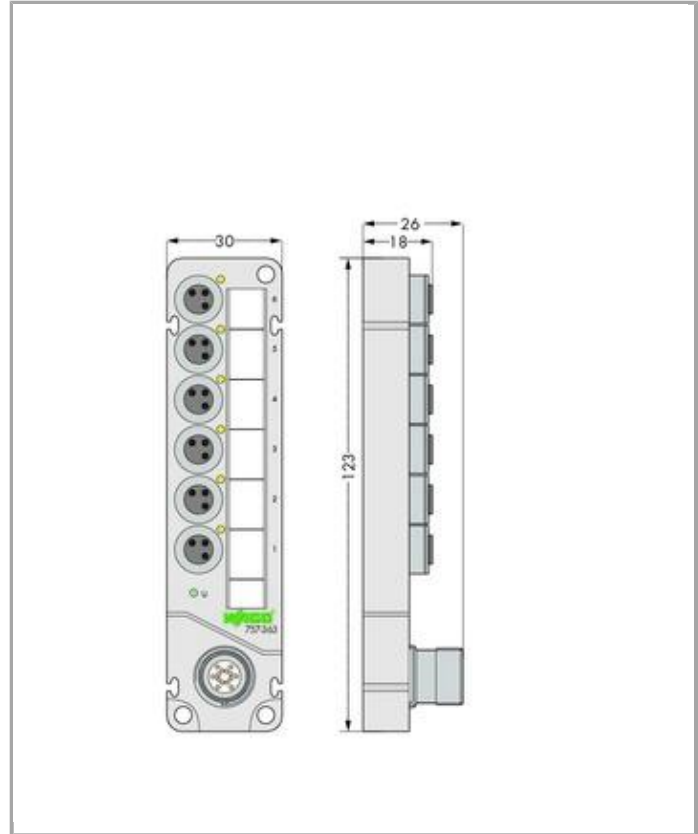

RoHS Compliant

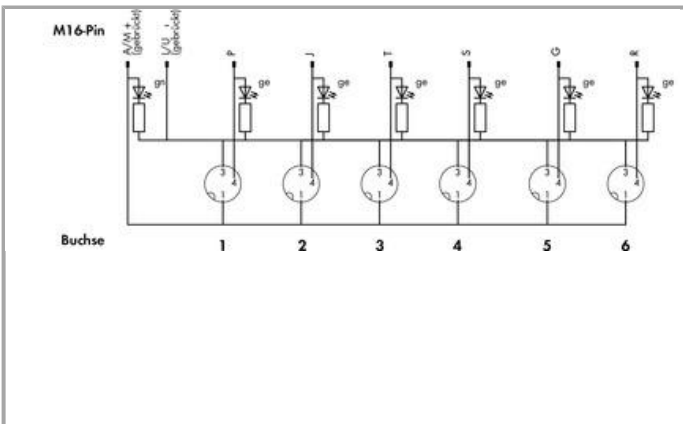

Item description

- M8 sensor/actuator box, 6-way
- 3-pole (1 signal per contact)

- M16 connector (14-pole)
- Green LED operating indicator
- Yellow LED status indicator
- incl. marker strips (note: WMB markers can also be used)
- incl. M8 protective caps (2 pcs)

Data

Technical Data

Contact resistance max.	0.01 Ω
Supply voltage	DC 10 ... 30 V; Bemessungsspannung: 32 V ~ eff.
Stromtragfähigkeit der Signalanschlüsse	2 A
Current carrying capacity of the supply connections	6 A
Bemessungswert der galvanischen Trennung	500 V
Funktional getrennte Potentialgruppen	Kontakt/Kontakt
Isolationswiderstand	1000 M Ω
Signal characteristic	PNP
Indicators	LED yellow: Signal status (1 x per contact); LED (U) green: Sensor /actuator box status

Connection data

Connection technology: inputs / outputs	6 x M8 connectors, 3 poles
Anschluss technik: Stammleitung	1 x Stecker M16; 14-polig

Geometrical Data

Width	30 mm / 1.181 inch
Height	26 mm / 1.024 inch
Depth	123 mm / 4.843 inch

Mechanical data

Mounting type	Screw mounting
---------------	----------------

Material Data

Housing material	PA 66 (UL 94 V0); RAL 7035; silicon and halogen free
Halogen-free	Yes
Materialeigenschaften der Anschlüsse	Contact: CuSn, pre-nickel- and 0.8 μ m gold-plated; Tapped bush: Zn diecast nickel-plated; Seal: Viton; Connection cycles: 50
Potting	Fully encapsulated with conformal coating (UL 94 V0)

Environmental Requirements

Surrounding air (operating) temperature	-25 ... 80 °C
---	---------------

Degree of protection	IP67
Degree of pollution (5)	3 acc. to VDE 0110
Vibration resistance	acc. to IEC 60068-2-6
Shock resistance	acc. to IEC 60068-2-27

Commercial data

Country of origin	DE
GTIN	4044918978682
Customs Tariff No.	85366990990
Product Group	23 (I/O passive and accessories)

Approvals / Certificates

UL-Approvals



Logo	Approval	Certificate name
	UL UL International Germany GmbH (ORDINARY LOCATIONS)	E175199 Sec.5

Compatible products



General accessories



	Item no.: 756-8101 M8 protective cap; for unused sockets	www.wago.com/756-8101
	Item no.: 757-060 Spacer module for sensor/actuator box; 6-way	www.wago.com/757-060

Marking accessories

	Item no.: 210-110 Fiber-tip pen	www.wago.com/210-110
	Item no.: 757-061 Marking strips; cut to a defined length; not stretchable; plain; snap-on type	www.wago.com/757-061

wiring and connectors

	Item no.: 756-3205/140-050 Connecting cable; for the connection of M8 sensor/actuator boxes; 14-pole; M16 socket, straight; one free cable end; 5 m	www.wago.com/756-3205/140-050
	Item no.: 756-3205/140-100 Connecting cable; for the connection of M8 sensor/actuator boxes; 14-pole; M16 socket, straight; one free cable end; 10 m	www.wago.com/756-3205/140-100
	Item no.: 756-3205/140-150 Connecting cable; for the connection of M8 sensor/actuator boxes; 14-pole; M16 socket, straight; one free cable end; 15 m	www.wago.com/756-3205/140-150
	Item no.: 756-3206/140-050	

	Connecting cable; for the connection of M8 sensor/actuator boxes; 14-pole; M16 socket, angled; one free cable end; 5 m	www.wago.com/756-3206/140-050
	Item no.: 756-3206/140-100 Connecting cable; for the connection of M8 sensor/actuator boxes; 14-pole; M16 socket, angled; one free cable end; 10 m	www.wago.com/756-3206/140-100
	Item no.: 756-3206/140-150 Connecting cable; for the connection of M8 sensor/actuator boxes; 14-pole; M16 socket, angled; one free cable end; 15 m	www.wago.com/756-3206/140-150

Downloads

Documentation

Additional Information

Disposal; Electrical and electronic equipment, Packaging	Oct 15, 2018	265.8 kB	Download
--	--------------	----------	----------

System Description

Sensor/Actuator Boxes – General Product Information	Jun 6, 2017	357.7 kB	Download
---	-------------	----------	----------

smartDATA

CAD data

3D Download 757-363	URL	Download
---------------------	-----	----------

Subject to changes.