

Data sheet | Item number: 769-156

2-pin carrier terminal block; for DIN-rail 35 x 15 and 35 x 7.5; 4 mm²

www.wago.com/769-156

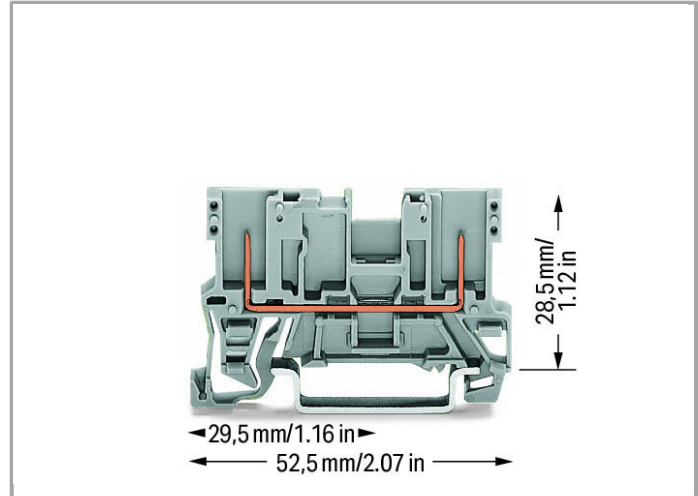
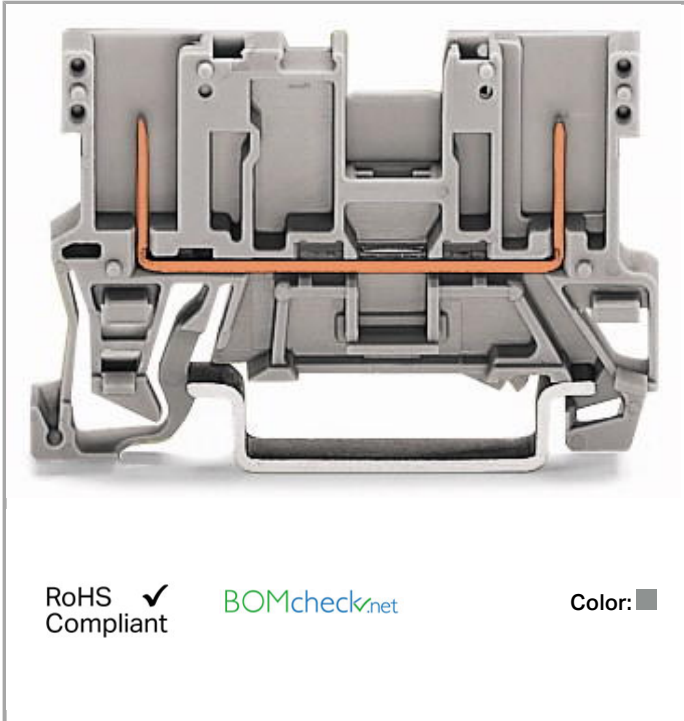

RoHS Compliant

[BOMcheck.net](https://www.bomcheck.net)

Color: ■

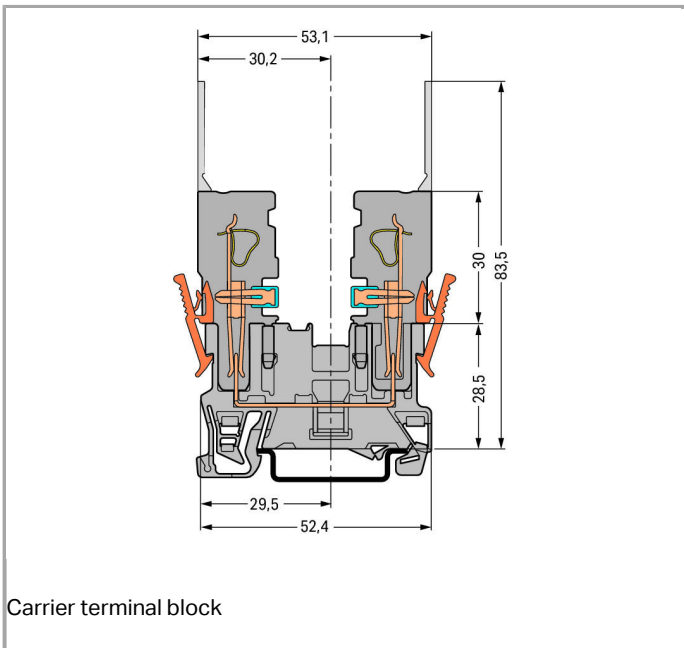

Carrier terminal block

Data
Electrical data



Ratings per IEC/EN 60664-1

Rated voltage (III / 3)	500 V
Rated impulse voltage (III / 3)	6 kV
Rated current	32 A
Legend (ratings)	(III / 3) $\hat{=}$ Overvoltage category III / Pollution degree 3

Connection data

Actuation type	Operating tool
Connectable conductor materials	Copper Aluminum
Total number of potentials	1
Number of levels	1
Type of wiring	Front-entry wiring

Geometrical Data

Width	5 mm / 0.197 inch
Height from upper-edge of DIN-35 rail	28.5 mm / 1.122 inch
Depth	52.5 mm / 2.067 inch

Mechanical data

Design	horizontal
Type of mounting	DIN-35 rail
Marking level	Center marking

Material Data

Color	gray
Insulating material	Polyamide 66 (PA 66)
Fire load	0.099 MJ
Weight	4.47 g



Commercial data

Country of origin	DE
GTIN	4044918391672
Customs Tariff No.	85369010000
Product Group	18 (X-COM-System)



Approvals / Certificates

Country specific Approvals



Logo	Approval	Certificate name

	CCA DEKRA Certification B.V.	NTR NL-7626
	CSA DEKRA Certification B.V.	1101144
	KEMA/KEUR DEKRA Certification B.V.	2190419.01

Ship Approvals



Logo	Approval	Certificate name
	ABS American Bureau of Shipping	14-HG1293677-PDA
	LR Lloyds Register	91/20112 (E9)

















UL-Approvals

















Logo	Approval	Certificate name
	UR Underwriters Laboratories Inc.	E45171
	UR Underwriters Laboratories Inc.	E45172

Compatible products

assembling

	Item no.: 209-106 Mounting carrier; for isolated mounting on DIN 35 rails	www.wago.com/209-106
Jumper		
	Item no.: 249-123 Push-in type wire jumper; insulated; wire length 180 mm; Conductor cross section 0.75 mm ²	www.wago.com/249-123
	Item no.: 249-125 Push-in type wire jumper; insulated; wire length 60 mm; Conductor cross section 0.75 mm ²	www.wago.com/249-125

	<p>Item no.: 249-126 Push-in type wire jumper; insulated; wire length 110 mm; Conductor cross section 0.75 mm²</p>	www.wago.com/249-126
	<p>Item no.: 249-127 Push-in type wire jumper; insulated; wire length 250 mm; Conductor cross section 0.75 mm²</p>	www.wago.com/249-127
	<p>Item no.: 280-402 Adjacent jumper; insulated; IN = IN terminal block</p>	www.wago.com/280-402
	<p>Item no.: 280-409 Alternate jumper; insulated; IN = IN terminal block</p>	www.wago.com/280-409
	<p>Item no.: 780-452 Staggered jumper; insulated; from 1 to 2; Spacing: 5 mm; suitable for 2-conductor female plugs</p>	www.wago.com/780-452
	<p>Item no.: 780-453 Staggered jumper; insulated; from 1 to 3; Spacing: 5 mm; suitable for 2-conductor female plugs</p>	www.wago.com/780-453
	<p>Item no.: 780-454 Staggered jumper; insulated; from 1 to 4; Spacing: 5 mm; suitable for 2-conductor female plugs</p>	www.wago.com/780-454
	<p>Item no.: 780-455 Staggered jumper; insulated; from 1 to 5; Spacing: 5 mm; suitable for 2-conductor female plugs</p>	www.wago.com/780-455
	<p>Item no.: 780-456 Staggered jumper; insulated; from 1 to 6; Spacing: 5 mm; suitable for 2-conductor female plugs</p>	www.wago.com/780-456
	<p>Item no.: 780-457 Staggered jumper; insulated; from 1 to 7; Spacing: 5 mm; suitable for 2-conductor female plugs</p>	www.wago.com/780-457
	<p>Item no.: 780-458 Staggered jumper; insulated; from 1 to 8; Spacing: 5 mm; suitable for 2-conductor female plugs</p>	www.wago.com/780-458
tools		
	<p>Item no.: 210-720 Operating tool with partially insulated shaft; Type 2, blade (3.5 x 0.5) mm</p>	www.wago.com/210-720
Coding		
	<p>Item no.: 769-435 Coding pin; for coding of female plugs; for carrier terminal blocks / male connectors</p>	www.wago.com/769-435
End plate		
	<p>Item no.: 769-305 End and intermediate plate; 1.1 mm thick</p>	www.wago.com/769-305
	<p>Item no.: 769-306 End and intermediate plate; 1.1 mm thick</p>	www.wago.com/769-306
General accessories		
	<p>Item no.: 280-404 Test plug adapter; 5 mm wide; for test plug 210-137 (2.3 mm Ø); suitable for 1.5 mm² - 4 mm² tbs</p>	www.wago.com/280-404
	<p>Item no.: 280-418 Test plug module; modular; suitable for all WAGO 280 and 780 Series rail-mounted terminal blocks with</p>	www.wago.com/280-418

	jumper slots in the current bar	
	Item no.: 280-419 Spacer module; modular; bridging commoned terminal blocks	www.wago.com/280-419
	Item no.: 769-438 Pin cover; with marker slot for miniature WSB	www.wago.com/769-438
	Item no.: 769-439 Pin cover; with marker slot for miniature WSB	www.wago.com/769-439
	Item no.: 769-501 Start module for 1-conductor female connector; with integrated end plate; 4 mm ² ; 1-pole	www.wago.com/769-501
	Item no.: 769-501/000-006 Start module for 1-conductor female connector; 4 mm ² ; 1-pole	www.wago.com/769-501/000-006
	Item no.: 769-501/000-016 Start module for 1-conductor female connector; with integrated end plate; 4 mm ² ; 1-pole	www.wago.com/769-501/000-016
	Item no.: 769-502 Center module for 1-conductor female connector; 4 mm ² ; 1-pole	www.wago.com/769-502
	Item no.: 769-502/000-006 Center module for 1-conductor female connector; 4 mm ² ; 1-pole	www.wago.com/769-502/000-006
	Item no.: 769-502/000-016 1-conductor center module; codable; can be commoned with miniature adjacent jumpers; 1-pole	www.wago.com/769-502/000-016
	Item no.: 769-503 End module for 1-conductor female connector; 4 mm ² ; 1-pole	www.wago.com/769-503
	Item no.: 769-503/000-006 End module for 1-conductor female connector; 4 mm ² ; 1-pole	www.wago.com/769-503/000-006
	Item no.: 769-503/000-016 End module for 1-conductor female connector; 4 mm ² ; 1-pole	www.wago.com/769-503/000-016
	Item no.: 769-504 2-conductor base module; with integrated end plate; codable; can be commoned with adjacent jumpers and staggered jumpers; 1-pole	www.wago.com/769-504
	Item no.: 769-504/000-006 Start module for 2-conductor female connector; with integrated end plate; 4 mm ² ; 1-pole	www.wago.com/769-504/000-006
	Item no.: 769-504/000-016 Start module for 2-conductor female connector; 4 mm ² ; 1-pole	www.wago.com/769-504/000-016
	Item no.: 769-505 Center module for 2-conductor female connector; 4 mm ² ; 1-pole	www.wago.com/769-505



Item no.: 769-505/000-006
Center module for 2-conductor female connector; 4 mm²; 1-pole

www.wago.com/769-505/000-006



Item no.: 769-505/000-016
Center module for 2-conductor female connector; 4 mm²; 1-pole

www.wago.com/769-505/000-016



Item no.: 769-506
2-conductor end module; codable; can be commoned with adjacent jumpers and staggered jumpers; 1-pole

www.wago.com/769-506



Item no.: 769-506/000-006
End module for 2-conductor female connector; 4 mm²; 1-pole

www.wago.com/769-506/000-006



Item no.: 769-506/000-016
End module for 2-conductor female connector; 4 mm²; 1-pole

www.wago.com/769-506/000-016



Item no.: 769-512
Start module for 1-conductor female connector; angled; 4 mm²; 1-pole

www.wago.com/769-512



Item no.: 769-512/000-006
Start module for 1-conductor female connector; angled; 4 mm²; 1-pole

www.wago.com/769-512/000-006



Item no.: 769-512/000-016
Start module for 1-conductor female connector; angled; 4 mm²; 1-pole

www.wago.com/769-512/000-016



Item no.: 769-513
Center module for 1-conductor female connector; angled; 4 mm²; 1-pole

www.wago.com/769-513



Item no.: 769-513/000-006
1-conductor center module; angled; codable; 1-pole

www.wago.com/769-513/000-006



Item no.: 769-513/000-016
1-conductor center module; angled; codable; 1-pole

www.wago.com/769-513/000-016



Item no.: 769-515
1-conductor end module; angled; codable; 1-pole

www.wago.com/769-515



Item no.: 769-515/000-006
1-conductor end module; angled; codable; 1-pole

www.wago.com/769-515/000-006



Item no.: 769-515/000-016
1-conductor end module; angled; codable; 1-pole















www.wago.com/769-515/000-016

Marking accessories



Item no.: 2009-145
Mini-WSB Inline; for smartPRINTER; on reel; stretchable 5 - 5.2 mm; plain; snap-on type

www.wago.com/2009-145

	<p>Item no.: 2009-145/000-002 Mini-WSB Inline; for smartPRINTER; on reel; stretchable 5 - 5.2 mm; plain; snap-on type</p>	www.wago.com/2009-145/000-002
	<p>Item no.: 2009-145/000-005 Mini-WSB Inline; for smartPRINTER; on reel; stretchable 5 - 5.2 mm; plain; snap-on type</p>	www.wago.com/2009-145/000-005
	<p>Item no.: 2009-145/000-006 Mini-WSB Inline; for smartPRINTER; on reel; stretchable 5 - 5.2 mm; plain; snap-on type</p>	www.wago.com/2009-145/000-006
	<p>Item no.: 2009-145/000-007 Mini-WSB Inline; for smartPRINTER; on reel; stretchable 5 - 5.2 mm; plain; snap-on type</p>	www.wago.com/2009-145/000-007
	<p>Item no.: 2009-145/000-012 Mini-WSB Inline; for smartPRINTER; on reel; stretchable 5 - 5.2 mm; plain; snap-on type</p>	www.wago.com/2009-145/000-012
	<p>Item no.: 2009-145/000-023 Mini-WSB Inline; for smartPRINTER; on reel; stretchable 5 - 5.2 mm; plain; snap-on type</p>	www.wago.com/2009-145/000-023
	<p>Item no.: 2009-145/000-024 Mini-WSB Inline; on reel; stretchable 5 - 5.2 mm; plain; snap-on type</p>	www.wago.com/2009-145/000-024
	<p>Item no.: 248-501 Miniature WSB Quick marking system; plain; Marker width 5 mm; 10 strips with 10 markers per card</p>	www.wago.com/248-501
	<p>Item no.: 248-501/000-002 Mini-WSB marking card; as card; not stretchable; plain; snap-on type</p>	www.wago.com/248-501/000-002
	<p>Item no.: 248-501/000-005 Mini-WSB marking card; as card; plain; snap-on type</p>	www.wago.com/248-501/000-005
	<p>Item no.: 248-501/000-006 Mini-WSB marking card; as card; not stretchable; plain; snap-on type</p>	www.wago.com/248-501/000-006
	<p>Item no.: 248-501/000-007 Mini-WSB marking card; as card; not stretchable; plain; snap-on type</p>	www.wago.com/248-501/000-007
	<p>Item no.: 248-501/000-012 Mini-WSB marking card; as card; not stretchable; plain; snap-on type</p>	www.wago.com/248-501/000-012
	<p>Item no.: 248-501/000-017 Mini-WSB marking card; as card; not stretchable; plain; snap-on type</p>	www.wago.com/248-501/000-017
	<p>Item no.: 248-501/000-023 Mini-WSB marking card; as card; not stretchable; plain; snap-on type</p>	www.wago.com/248-501/000-023



Item no.: 248-501/000-024
Mini-WSB marking card; as card; not stretchable; plain; snap-on type

www.wago.com/248-501/000-024

check

Item no.: 210-137
Test plug; 2.3 mm Ø; with 500 mm cable

www.wago.com/210-137

Carrier rail

Item no.: 210-112
Steel carrier rail; 35 x 7.5 mm; 1 mm thick; 2 m long; slotted; according to EN 60715; "Hole width 25 mm

www.wago.com/210-112



Item no.: 210-113
Steel carrier rail; 35 x 7.5 mm; 1 mm thick; 2 m long; unslotted; according to EN 60715

www.wago.com/210-113



Item no.: 210-114
Steel carrier rail; 35 x 15 mm; 1.5 mm thick; 2 m long; unslotted; similar to EN 60715

www.wago.com/210-114



Item no.: 210-115
Steel carrier rail; 35 x 7.5 mm; 1 mm thick; 2 m long; slotted; according to EN 60715; "Hole width 18 mm

www.wago.com/210-115



Item no.: 210-118
Steel carrier rail; 35 x 15 mm; 2.3 mm thick; 2 m long; unslotted; according to EN 60715

www.wago.com/210-118



Item no.: 210-196
Aluminum carrier rail; 35 x 8.2 mm; 1.6 mm thick; 2 m long; unslotted; similar to EN 60715

www.wago.com/210-196



Item no.: 210-197
Steel carrier rail; 35 x 15 mm; 1.5 mm thick; 2 m long; slotted; similar to EN 60715

www.wago.com/210-197



Item no.: 210-198
Copper carrier rail; 35 x 15 mm; 2.3 mm thick; 2 m long; unslotted; according to EN 60715

www.wago.com/210-198



Item no.: 210-504
Steel carrier rail; 35 x 7.5 mm; 1 mm thick; 2 m long; slotted; galvanized; according to EN 60715

www.wago.com/210-504



Item no.: 210-505
Steel carrier rail; 35 x 7.5 mm; 1 mm thick; 2 m long; unslotted; galvanized; according to EN 60715

www.wago.com/210-505



Item no.: 210-506
Steel carrier rail; 35 x 15 mm; 1.5 mm thick; 2 m long; unslotted; galvanized; similar to EN 60715

www.wago.com/210-506



Item no.: 210-508
Steel carrier rail; 35 x 15 mm; 1.5 mm thick; 2 m long; slotted; galvanized; similar to EN 60715

www.wago.com/210-508

Female plug

Item no.: 769-101
1-conductor female plug; 4 mm²; 1-pole

www.wago.com/769-101



Item no.: 769-101/000-006
1-conductor female plug; 4 mm²; 1-pole

www.wago.com/769-101/000-006

Item no.: 769-101/000-016
1-conductor female plug; 4 mm²; 1-pole

www.wago.com/769-101/000-016



Item no.: 769-101/022-000
1-conductor female plug; angled; 4 mm²; 1-pole

www.wago.com/769-101/022-000



Item no.: 769-101/022-016
1-conductor female plug; angled; 4 mm²; 1-pole

www.wago.com/769-101/022-016



Item no.: 769-102
1-conductor female plug; 4 mm²; 2-pole

www.wago.com/769-102

Item no.: 769-102/000-006
1-conductor female plug; 4 mm²; 2-pole

www.wago.com/769-102/000-006

Item no.: 769-102/000-036
1-conductor female plug; 4 mm²; 2-pole

www.wago.com/769-102/000-036

Item no.: 769-102/000-037
1-conductor female plug; 4 mm²; 2-pole

www.wago.com/769-102/000-037



Item no.: 769-102/022-000
1-conductor female plug; angled; 4 mm²; 2-pole

www.wago.com/769-102/022-000

Item no.: 769-103
1-conductor female plug; 4 mm²; 3-pole

www.wago.com/769-103

Item no.: 769-103/000-006
1-conductor female plug; 4 mm²; 3-pole

www.wago.com/769-103/000-006



Item no.: 769-103/000-036
1-conductor female plug; 4 mm²; 3-pole

www.wago.com/769-103/000-036



Item no.: 769-103/000-037
1-conductor female plug; 4 mm²; 3-pole

www.wago.com/769-103/000-037



Item no.: 769-103/000-038
1-conductor female plug; 4 mm²; 3-pole

www.wago.com/769-103/000-038



Item no.: 769-103/000-039
1-conductor female plug; 4 mm²; 3-pole

www.wago.com/769-103/000-039















Item no.: 769-103/022-000
1-conductor female plug; angled; 4 mm²; 3-pole

www.wago.com/769-103/022-000

Item no.: 769-104
1-conductor female plug; 4 mm²; 4-pole

www.wago.com/769-104

	Item no.: 769-104/000-006 1-conductor female plug; 4 mm ² ; 4-pole	www.wago.com/769-104/000-006
	Item no.: 769-104/000-036 1-conductor female plug; 4 mm ² ; 4-pole	www.wago.com/769-104/000-036
	Item no.: 769-104/000-037 1-conductor female plug; 4 mm ² ; 4-pole	www.wago.com/769-104/000-037
	Item no.: 769-104/000-038 1-conductor female plug; 4 mm ² ; 4-pole	www.wago.com/769-104/000-038
	Item no.: 769-104/000-039 1-conductor female plug; 4 mm ² ; 4-pole	www.wago.com/769-104/000-039
	Item no.: 769-104/022-000 1-conductor female plug; angled; 4 mm ² ; 4-pole	www.wago.com/769-104/022-000
	Item no.: 769-105 1-conductor female plug; 4 mm ² ; 5-pole	www.wago.com/769-105
	Item no.: 769-105/000-006 1-conductor female plug; 4 mm ² ; 5-pole	www.wago.com/769-105/000-006
	Item no.: 769-105/000-036 1-conductor female plug; 4 mm ² ; 5-pole	www.wago.com/769-105/000-036
	Item no.: 769-105/000-037 1-conductor female plug; 4 mm ² ; 5-pole	www.wago.com/769-105/000-037
	Item no.: 769-105/000-038 1-conductor female plug; 4 mm ² ; 5-pole	www.wago.com/769-105/000-038
	Item no.: 769-105/000-039 1-conductor female plug; 4 mm ² ; 5-pole	www.wago.com/769-105/000-039
	Item no.: 769-105/022-000 1-conductor female plug; angled; 4 mm ² ; 5-pole	www.wago.com/769-105/022-000
	Item no.: 769-106 1-conductor female plug; 4 mm ² ; 6-pole	www.wago.com/769-106
	Item no.: 769-106/000-006 1-conductor female plug; 4 mm ² ; 6-pole	www.wago.com/769-106/000-006



Item no.: 769-106/000-036
1-conductor female plug; 4 mm²; 6-pole

www.wago.com/769-106/000-036



Item no.: 769-106/000-037
1-conductor female plug; 4 mm²; 6-pole

www.wago.com/769-106/000-037



Item no.: 769-106/000-038
1-conductor female plug; 4 mm²; 6-pole

www.wago.com/769-106/000-038



Item no.: 769-106/000-039
1-conductor female plug; 4 mm²; 6-pole

www.wago.com/769-106/000-039

Item no.: 769-106/022-000
1-conductor female plug; angled; 4 mm²; 6-pole

www.wago.com/769-106/022-000

Item no.: 769-107
1-conductor female plug; 4 mm²; 7-pole

www.wago.com/769-107

Item no.: 769-107/000-006
1-conductor female plug; 4 mm²; 7-pole

www.wago.com/769-107/000-006



Item no.: 769-107/000-036
1-conductor female plug; 4 mm²; 7-pole

www.wago.com/769-107/000-036



Item no.: 769-107/000-037
1-conductor female plug; 4 mm²; 7-pole

www.wago.com/769-107/000-037



Item no.: 769-107/000-038
1-conductor female plug; 4 mm²; 7-pole

www.wago.com/769-107/000-038



Item no.: 769-107/000-039
1-conductor female plug; 4 mm²; 7-pole

www.wago.com/769-107/000-039

Item no.: 769-107/022-000
1-conductor female plug; angled; 4 mm²; 7-pole

www.wago.com/769-107/022-000

Item no.: 769-108
1-conductor female plug; 4 mm²; 8-pole





www.wago.com/769-108

Item no.: 769-108/000-006
1-conductor female plug; 4 mm²; 8-pole

www.wago.com/769-108/000-006

Item no.: 769-108/000-036
1-conductor female plug; 4 mm²; 8-pole

www.wago.com/769-108/000-036

<p>Item no.: 769-108/000-037 1-conductor female plug; 4 mm²; 8-pole</p>	<p>www.wago.com/769-108/000-037</p>	
<p>Item no.: 769-108/000-038 1-conductor female plug; 4 mm²; 8-pole</p>	<p>www.wago.com/769-108/000-038</p>	
<p>Item no.: 769-108/000-039 1-conductor female plug; 4 mm²; 8-pole</p>	<p>www.wago.com/769-108/000-039</p>	
<p>Item no.: 769-108/022-000 1-conductor female plug; angled; 4 mm²; 8-pole</p>	<p>www.wago.com/769-108/022-000</p>	
<p>Item no.: 769-109 1-conductor female plug; 4 mm²; 9-pole</p>	<p>www.wago.com/769-109</p>	
<p>Item no.: 769-109/000-006 1-conductor female plug; 4 mm²; 9-pole</p>	<p>www.wago.com/769-109/000-006</p>	
	<p>Item no.: 769-109/000-036 1-conductor female plug; 4 mm²; 9-pole</p>	<p>www.wago.com/769-109/000-036</p>
	<p>Item no.: 769-109/000-037 1-conductor female plug; 4 mm²; 9-pole</p>	<p>www.wago.com/769-109/000-037</p>
	<p>Item no.: 769-109/000-038 1-conductor female plug; 4 mm²; 9-pole</p>	<p>www.wago.com/769-109/000-038</p>
	<p>Item no.: 769-109/000-039 1-conductor female plug; 4 mm²; 9-pole</p>	<p>www.wago.com/769-109/000-039</p>
<p>Item no.: 769-109/022-000 1-conductor female plug; angled; 4 mm²; 9-pole</p>	<p>www.wago.com/769-109/022-000</p>	
<p>Item no.: 769-110 1-conductor female plug; 4 mm²; 10-pole</p>	<p>www.wago.com/769-110</p>	
<p>Item no.: 769-110/000-006 1-conductor female plug; 4 mm²; 10-pole</p>	<p>www.wago.com/769-110/000-006</p>	
<p>Item no.: 769-110/000-036 1-conductor female plug; 4 mm²; 10-pole</p>	<p>www.wago.com/769-110/000-036</p>	
<p>Item no.: 769-110/000-037 1-conductor female plug; 4 mm²; 10-pole</p>	<p>www.wago.com/769-110/000-037</p>	

Item no.: 769-110/000-0381-conductor female plug; 4 mm²; 10-polewww.wago.com/769-110/000-038**Item no.: 769-110/000-039**1-conductor female plug; 4 mm²; 10-polewww.wago.com/769-110/000-039**Item no.: 769-110/022-000**1-conductor female plug; angled; 4 mm²; 10-polewww.wago.com/769-110/022-000**Item no.: 769-111**1-conductor female plug; 4 mm²; 11-polewww.wago.com/769-111**Item no.: 769-111/000-006**1-conductor female plug; 4 mm²; 11-polewww.wago.com/769-111/000-006**Item no.: 769-111/000-036**1-conductor female plug; 4 mm²; 11-polewww.wago.com/769-111/000-036**Item no.: 769-111/000-037**1-conductor female plug; 4 mm²; 11-polewww.wago.com/769-111/000-037**Item no.: 769-111/000-038**1-conductor female plug; 4 mm²; 11-polewww.wago.com/769-111/000-038**Item no.: 769-111/000-039**1-conductor female plug; 4 mm²; 11-polewww.wago.com/769-111/000-039**Item no.: 769-111/022-000**1-conductor female plug; angled; 4 mm²; 11-polewww.wago.com/769-111/022-000**Item no.: 769-112**1-conductor female plug; 4 mm²; 12-polewww.wago.com/769-112**Item no.: 769-112/000-006**1-conductor female plug; 4 mm²; 12-polewww.wago.com/769-112/000-006**Item no.: 769-112/000-036**1-conductor female plug; 4 mm²; 12-polewww.wago.com/769-112/000-036**Item no.: 769-112/000-037**1-conductor female plug; 4 mm²; 12-polewww.wago.com/769-112/000-037**Item no.: 769-112/000-038**1-conductor female plug; 4 mm²; 12-polewww.wago.com/769-112/000-038



Item no.: 769-112/000-039

1-conductor female plug; 4 mm²; 12-pole

www.wago.com/769-112/000-039

Item no.: 769-112/022-000

1-conductor female plug; angled; 4 mm²; 12-pole

www.wago.com/769-112/022-000

Item no.: 769-113

1-conductor female plug; 4 mm²; 13-pole

www.wago.com/769-113

Item no.: 769-113/000-036

1-conductor female plug; 4 mm²; 13-pole

www.wago.com/769-113/000-036

Item no.: 769-113/000-037

1-conductor female plug; 4 mm²; 13-pole

www.wago.com/769-113/000-037

Item no.: 769-113/000-038

1-conductor female plug; 4 mm²; 13-pole

www.wago.com/769-113/000-038

Item no.: 769-113/000-039

1-conductor female plug; 4 mm²; 13-pole

www.wago.com/769-113/000-039

Item no.: 769-113/022-000

1-conductor female plug; angled; 4 mm²; 13-pole

www.wago.com/769-113/022-000

Item no.: 769-114

1-conductor female plug; 4 mm²; 14-pole

www.wago.com/769-114

Item no.: 769-114/000-006

1-conductor female plug; 4 mm²; 14-pole

www.wago.com/769-114/000-006

Item no.: 769-114/000-036

1-conductor female plug; 4 mm²; 14-pole

www.wago.com/769-114/000-036

Item no.: 769-114/000-037

1-conductor female plug; 4 mm²; 14-pole

www.wago.com/769-114/000-037

Item no.: 769-114/000-038

1-conductor female plug; 4 mm²; 14-pole

www.wago.com/769-114/000-038

Item no.: 769-114/000-039





1-conductor female plug; 4 mm²; 14-pole

www.wago.com/769-114/000-039

Item no.: 769-114/022-000

1-conductor female plug; angled; 4 mm²; 14-pole

www.wago.com/769-114/022-000

	Item no.: 769-115 1-conductor female plug; 4 mm ² ; 15-pole	www.wago.com/769-115
	Item no.: 769-115/000-036 1-conductor female plug; 4 mm ² ; 15-pole	www.wago.com/769-115/000-036
	Item no.: 769-115/000-037 1-conductor female plug; 4 mm ² ; 15-pole	www.wago.com/769-115/000-037
	Item no.: 769-115/000-038 1-conductor female plug; 4 mm ² ; 15-pole	www.wago.com/769-115/000-038
	Item no.: 769-115/000-039 1-conductor female plug; 4 mm ² ; 15-pole	www.wago.com/769-115/000-039
	Item no.: 769-115/022-000 1-conductor female plug; angled; 4 mm ² ; 15-pole	www.wago.com/769-115/022-000
	Item no.: 769-121 2-conductor female connector; 4 mm ² ; 1-pole	www.wago.com/769-121
	Item no.: 769-121/000-016 2-conductor female connector; 4 mm ² ; 1-pole	www.wago.com/769-121/000-016
	Item no.: 769-122 2-conductor female connector; 4 mm ² ; 2-pole	www.wago.com/769-122
	Item no.: 769-123 2-conductor female connector; 4 mm ² ; 3-pole	www.wago.com/769-123
	Item no.: 769-124 2-conductor female connector; 4 mm ² ; 4-pole	www.wago.com/769-124
	Item no.: 769-125 2-conductor female connector; 4 mm ² ; 5-pole	www.wago.com/769-125
	Item no.: 769-126 2-conductor female connector; 4 mm ² ; 6-pole	www.wago.com/769-126
	Item no.: 769-127 2-conductor female connector; 4 mm ² ; 7-pole	www.wago.com/769-127
	Item no.: 769-128 2-conductor female connector; 4 mm ² ; 8-pole	www.wago.com/769-128
	Item no.: 769-129 2-conductor female connector; 4 mm ² ; 9-pole	www.wago.com/769-129
	Item no.: 769-130 2-conductor female connector; 4 mm ² ; 10-pole	www.wago.com/769-130
	Item no.: 769-131 2-conductor female connector; 4 mm ² ; 11-pole	www.wago.com/769-131



Item no.: 769-132

2-conductor female connector; 4 mm²; 12-pole

www.wago.com/769-132

Item no.: 769-133

2-conductor female connector; 4 mm²; 13-pole

www.wago.com/769-133

Item no.: 769-134

2-conductor female connector; 4 mm²; 14-pole

www.wago.com/769-134

Item no.: 769-135

2-conductor female connector; 4 mm²; 15-pole

www.wago.com/769-135

Downloads

Documentation

Bid Text

769-156	Oct 18, 2017	DOC 24.6 kB	Download
---------	--------------	----------------	----------

smartDATA

CAD data

3D Download 769-156	URL	Download
---------------------	-----	----------

Product family

X-COM

[Learn more about the product family.](#)

[Show all products from the family](#)

Subject to changes.