

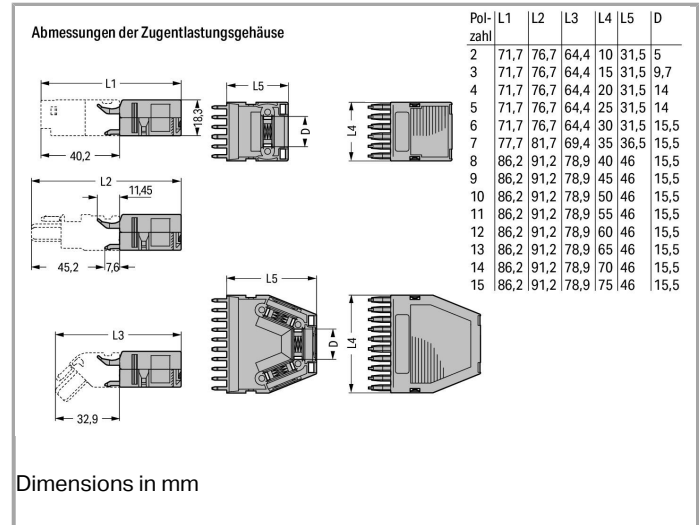

RoHS Compliant

BOMcheck.net

Color:



Data

Connection data

No. of poles 2

Geometrical Data

Width 10 mm / 0.394 inch

Height 18.3 mm / 0.72 inch

Depth 31.5 mm / 1.24 inch

Material Data

Color gray

Fire load 0.085 MJ

Weight 2.85 g

Commercial data

Country of origin DE

GTIN 4017332652926









Customs Tariff No. 8538909990

Product Group

18 (X-COM-System)

## Compatible products

### Marking accessories

	<b>Item no.: 209-501</b> WSB marking card; as card; not stretchable; plain; snap-on type	<a href="http://www.wago.com/209-501">www.wago.com/209-501</a>
	<b>Item no.: 209-501/000-002</b> WSB marking card; as card; not stretchable; plain; snap-on type	<a href="http://www.wago.com/209-501/000-002">www.wago.com/209-501/000-002</a>
	<b>Item no.: 209-501/000-005</b> WSB marking card; as card; not stretchable; plain; snap-on type	<a href="http://www.wago.com/209-501/000-005">www.wago.com/209-501/000-005</a>
	<b>Item no.: 209-501/000-006</b> WSB marking card; as card; not stretchable; plain; snap-on type	<a href="http://www.wago.com/209-501/000-006">www.wago.com/209-501/000-006</a>
	<b>Item no.: 209-501/000-007</b> WSB marking card; as card; not stretchable; plain; snap-on type	<a href="http://www.wago.com/209-501/000-007">www.wago.com/209-501/000-007</a>
	<b>Item no.: 209-501/000-012</b> WSB marking card; as card; not stretchable; plain; snap-on type	<a href="http://www.wago.com/209-501/000-012">www.wago.com/209-501/000-012</a>
	<b>Item no.: 209-501/000-017</b> WSB marking card; as card; not stretchable; plain; snap-on type	<a href="http://www.wago.com/209-501/000-017">www.wago.com/209-501/000-017</a>
	<b>Item no.: 209-501/000-023</b> WSB marking card; as card; not stretchable; plain; snap-on type	<a href="http://www.wago.com/209-501/000-023">www.wago.com/209-501/000-023</a>
	<b>Item no.: 209-501/000-024</b> WSB marking card; as card; not stretchable; plain; snap-on type	<a href="http://www.wago.com/209-501/000-024">www.wago.com/209-501/000-024</a>

## Downloads

### Documentation

#### Bid Text

769-1602	Oct 19, 2017	DOC 23.6 kB	Download
----------	--------------	----------------	----------

## smartDATA

### CAD data

3D Download 769-1602	URL	Download
----------------------	-----	----------



---

Subject to changes.

---

WAGO Kontakttechnik GmbH & Co. KG  
Hansastr. 27  
32423 Minden  
Phone: +49571 887-0 | Fax: +49571 887-169  
Email: [info.de@wago.com](mailto:info.de@wago.com) | Web: [www.wago.com](http://www.wago.com)

Do you have any questions about our products?  
We are always happy to take your call at +49 (571) 887-44222.