

RoHS Compliant

BOMcheck.net

Color:

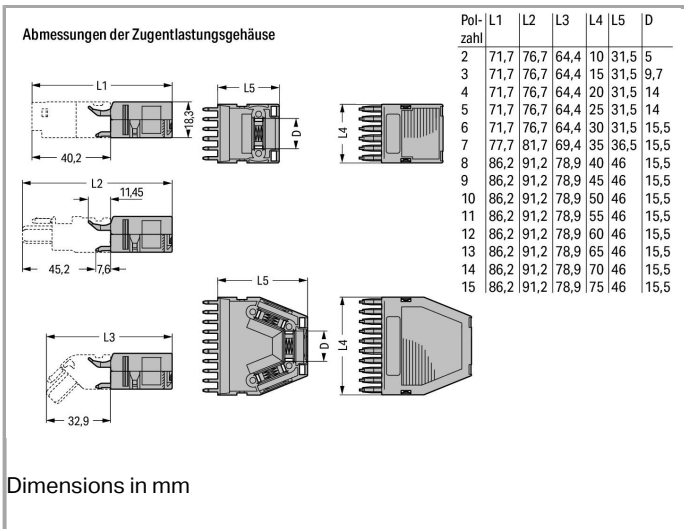

Data

Connection data

No. of poles

5

Geometrical Data

Width

25 mm / 0.984 inch

Height	18.3 mm / 0.72 inch
Depth	31.5 mm / 1.24 inch

Material Data









Color	gray
Fire load	0.16 MJ
Weight	5.33 g

Commercial data

Country of origin	DE
GTIN	4017332652889
Customs Tariff No.	85389099990
Product Group	18 (X-COM-System)

Compatible products

Marking accessories

	Item no.: 209-501 WSB marking card; as card; not stretchable; plain; snap-on type	www.wago.com/209-501
	Item no.: 209-501/000-002 WSB marking card; as card; not stretchable; plain; snap-on type	www.wago.com/209-501/000-002
	Item no.: 209-501/000-005 WSB marking card; as card; not stretchable; plain; snap-on type	www.wago.com/209-501/000-005
	Item no.: 209-501/000-006 WSB marking card; as card; not stretchable; plain; snap-on type	www.wago.com/209-501/000-006
	Item no.: 209-501/000-007 WSB marking card; as card; not stretchable; plain; snap-on type	www.wago.com/209-501/000-007
	Item no.: 209-501/000-012 WSB marking card; as card; not stretchable; plain; snap-on type	www.wago.com/209-501/000-012
	Item no.: 209-501/000-017 WSB marking card; as card; not stretchable; plain; snap-on type	www.wago.com/209-501/000-017
	Item no.: 209-501/000-023 WSB marking card; as card; not stretchable; plain; snap-on type	www.wago.com/209-501/000-023
	Item no.: 209-501/000-024 WSB marking card; as card; not stretchable; plain; snap-on type	www.wago.com/209-501/000-024



Downloads

Documentation

Bid Text

769-1605	Oct 19, 2017	DOC 23.6 kB	Download
----------	--------------	----------------	----------

smartDATA

CAD data

3D Download 769-1605	URL	Download
----------------------	-----	----------

Subject to changes.