

Data sheet | Item number: 769-176

1-conductor/1-pin carrier terminal block; for DIN-rail 35 x 15 and 35 x 7.5; 4 mm<sup>2</sup>; CAGE CLAMP®

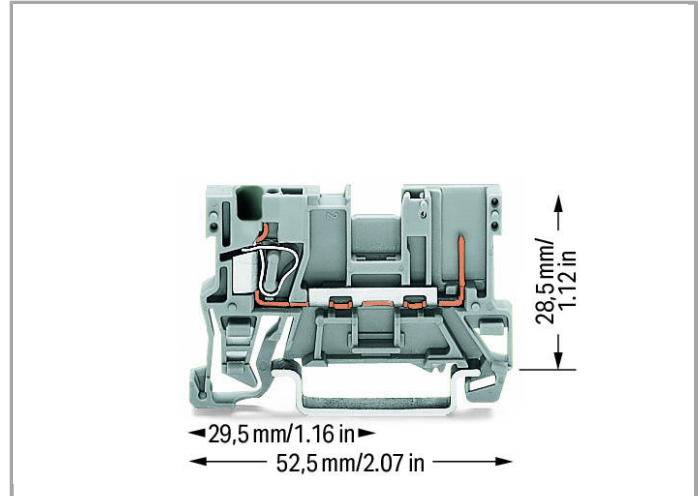

[www.wago.com/769-176](http://www.wago.com/769-176)

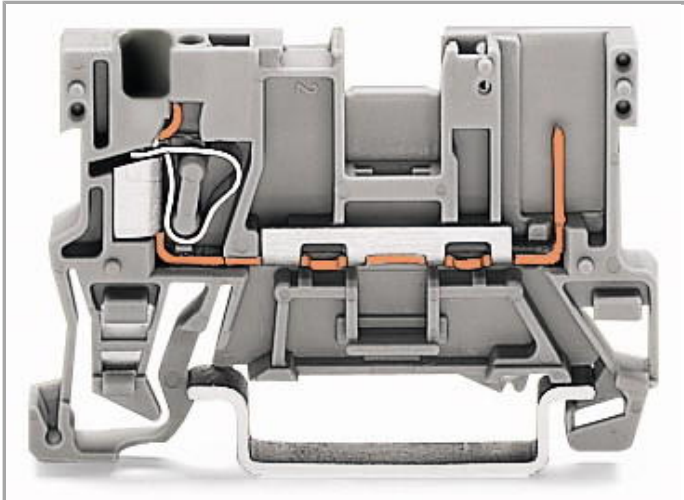

RoHS  Compliant

[BOMcheck.net](https://www.bomcheck.net)

Color: ■

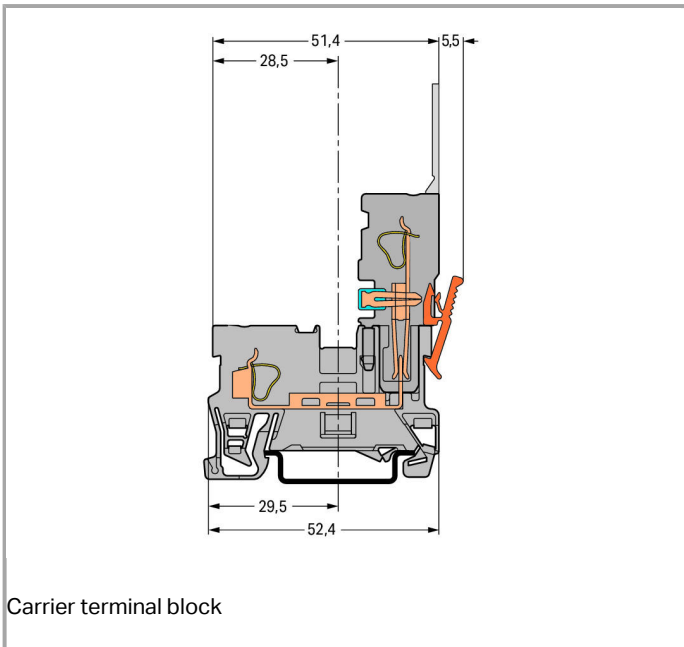

Data  
Electrical data



### Ratings per IEC/EN 60664-1

Rated voltage (III / 3)	500 V
Rated impulse voltage (III / 3)	6 kV
Rated current	32 A
Legend (ratings)	(III / 3) $\hat{=}$ Overvoltage category III / Pollution degree 3

### Connection data

Connection technology	CAGE CLAMP®
Actuation type	Operating tool
Connectable conductor materials	Copper Aluminum
Nominal cross section	4 mm <sup>2</sup>
Solid conductor	0.08 ... 4 mm <sup>2</sup> / 28 ... 12 AWG
Fine-stranded conductor	0.08 ... 4 mm <sup>2</sup> / 28 ... 12 AWG
Strip length	8 ... 9 mm / 0.31 ... 0.35 Inch
Total number of connection points	1
Total number of potentials	1
Number of levels	1
Type of wiring	Front-entry wiring

### Geometrical Data

Width	5 mm / 0.197 inch
Height from upper-edge of DIN-35 rail	28.5 mm / 1.122 inch
Depth	52.5 mm / 2.067 inch

### Mechanical data

Design	horizontal
Type of mounting	DIN-35 rail
Marking level	Center marking

### Material Data

Color	gray
Insulating material	Polyamide 66 (PA 66)
Fire load	0.101 MJ
Weight	5.27 g



### Commercial data

Country of origin	CN
GTIN	4045454871697



Customs Tariff No.	85366990990
Product Group	18 (X-COM-System)

## Approvals / Certificates



### Country specific Approvals

Logo	Approval	Certificate name
	<b>CCA</b> DEKRA Certification B.V.	NTR NL-7626
	<b>CSA</b> DEKRA Certification B.V.	1101144
	<b>KEMA/KEUR</b> DEKRA Certification B.V.	2190419.01

### Ship Approvals

Logo	Approval	Certificate name
	<b>ABS</b> American Bureau of Shipping	14-HG1293677-PDA
	<b>LR</b> Lloyds Register	91/20112 (E9)

### UL-Approvals

Logo	Approval	Certificate name
	<b>UR</b> Underwriters Laboratories Inc.	E45171
	<b>UR</b> Underwriters Laboratories Inc.	E45172

## Compatible products

### Jumper



Item no.: 249-123

Push-in type wire jumper; insulated; wire length 180 mm; Conductor cross section 0.75 mm<sup>2</sup>[www.wago.com/249-123](http://www.wago.com/249-123)

**Item no.: 249-125**Push-in type wire jumper; insulated; wire length 60 mm; Conductor cross section 0.75 mm<sup>2</sup>[www.wago.com/249-125](http://www.wago.com/249-125)**Item no.: 249-126**Push-in type wire jumper; insulated; wire length 110 mm; Conductor cross section 0.75 mm<sup>2</sup>[www.wago.com/249-126](http://www.wago.com/249-126)**Item no.: 249-127**Push-in type wire jumper; insulated; wire length 250 mm; Conductor cross section 0.75 mm<sup>2</sup>[www.wago.com/249-127](http://www.wago.com/249-127)**Item no.: 280-402**

Adjacent jumper; insulated; IN = IN terminal block

[www.wago.com/280-402](http://www.wago.com/280-402)**Item no.: 280-409**

Alternate jumper; insulated; IN = IN terminal block

[www.wago.com/280-409](http://www.wago.com/280-409)**Item no.: 780-452**

Staggered jumper; insulated; from 1 to 2; Spacing: 5 mm; suitable for 2-conductor female plugs

[www.wago.com/780-452](http://www.wago.com/780-452)**Item no.: 780-453**

Staggered jumper; insulated; from 1 to 3; Spacing: 5 mm; suitable for 2-conductor female plugs

[www.wago.com/780-453](http://www.wago.com/780-453)**Item no.: 780-454**

Staggered jumper; insulated; from 1 to 4; Spacing: 5 mm; suitable for 2-conductor female plugs

[www.wago.com/780-454](http://www.wago.com/780-454)**Item no.: 780-455**

Staggered jumper; insulated; from 1 to 5; Spacing: 5 mm; suitable for 2-conductor female plugs

[www.wago.com/780-455](http://www.wago.com/780-455)**Item no.: 780-456**

Staggered jumper; insulated; from 1 to 6; Spacing: 5 mm; suitable for 2-conductor female plugs

[www.wago.com/780-456](http://www.wago.com/780-456)**Item no.: 780-457**

Staggered jumper; insulated; from 1 to 7; Spacing: 5 mm; suitable for 2-conductor female plugs

[www.wago.com/780-457](http://www.wago.com/780-457)**Item no.: 780-458**

Staggered jumper; insulated; from 1 to 8; Spacing: 5 mm; suitable for 2-conductor female plugs

[www.wago.com/780-458](http://www.wago.com/780-458)

#### tools

**Item no.: 210-720**

Operating tool with partially insulated shaft; Type 2, blade (3.5 x 0.5) mm

[www.wago.com/210-720](http://www.wago.com/210-720)

#### Insulation stop

**Item no.: 769-470**Insulation stop; 0.08 - 0.2 mm<sup>2</sup> "s" (0.14 mm<sup>2</sup> "f-st"); 5 pieces/strip[www.wago.com/769-470](http://www.wago.com/769-470)**Item no.: 769-471**Insulation stop; 0.25 - 0.5 mm<sup>2</sup>; 5 pieces/strip[www.wago.com/769-471](http://www.wago.com/769-471)**Item no.: 769-472**Insulation stop; 0.75 - 1 mm<sup>2</sup>; 5 pieces/strip[www.wago.com/769-472](http://www.wago.com/769-472)

#### check

**Item no.: 210-136**

Test plug; 2 mm Ø; with 500 mm cable









[www.wago.com/210-136](http://www.wago.com/210-136)**Item no.: 210-137**

Test plug; 2.3 mm Ø; with 500 mm cable

[www.wago.com/210-137](http://www.wago.com/210-137)



## Female plug

	<b>Item no.: 769-101</b> 1-conductor female plug; 4 mm <sup>2</sup> ; 1-pole	<a href="http://www.wago.com/769-101">www.wago.com/769-101</a>
	<b>Item no.: 769-101/000-006</b> 1-conductor female plug; 4 mm <sup>2</sup> ; 1-pole	<a href="http://www.wago.com/769-101/000-006">www.wago.com/769-101/000-006</a>
	<b>Item no.: 769-101/000-016</b> 1-conductor female plug; 4 mm <sup>2</sup> ; 1-pole	<a href="http://www.wago.com/769-101/000-016">www.wago.com/769-101/000-016</a>
	<b>Item no.: 769-101/022-000</b> 1-conductor female plug; angled; 4 mm <sup>2</sup> ; 1-pole	<a href="http://www.wago.com/769-101/022-000">www.wago.com/769-101/022-000</a>
	<b>Item no.: 769-101/022-016</b> 1-conductor female plug; angled; 4 mm <sup>2</sup> ; 1-pole	<a href="http://www.wago.com/769-101/022-016">www.wago.com/769-101/022-016</a>
	<b>Item no.: 769-102</b> 1-conductor female plug; 4 mm <sup>2</sup> ; 2-pole	<a href="http://www.wago.com/769-102">www.wago.com/769-102</a>
	<b>Item no.: 769-102/000-006</b> 1-conductor female plug; 4 mm <sup>2</sup> ; 2-pole	<a href="http://www.wago.com/769-102/000-006">www.wago.com/769-102/000-006</a>
	<b>Item no.: 769-102/000-036</b> 1-conductor female plug; 4 mm <sup>2</sup> ; 2-pole	<a href="http://www.wago.com/769-102/000-036">www.wago.com/769-102/000-036</a>
	<b>Item no.: 769-102/000-037</b> 1-conductor female plug; 4 mm <sup>2</sup> ; 2-pole	<a href="http://www.wago.com/769-102/000-037">www.wago.com/769-102/000-037</a>
	<b>Item no.: 769-102/022-000</b> 1-conductor female plug; angled; 4 mm <sup>2</sup> ; 2-pole	<a href="http://www.wago.com/769-102/022-000">www.wago.com/769-102/022-000</a>
	<b>Item no.: 769-103</b> 1-conductor female plug; 4 mm <sup>2</sup> ; 3-pole	<a href="http://www.wago.com/769-103">www.wago.com/769-103</a>
	<b>Item no.: 769-103/000-006</b> 1-conductor female plug; 4 mm <sup>2</sup> ; 3-pole	<a href="http://www.wago.com/769-103/000-006">www.wago.com/769-103/000-006</a>
	<b>Item no.: 769-103/000-036</b> 1-conductor female plug; 4 mm <sup>2</sup> ; 3-pole	<a href="http://www.wago.com/769-103/000-036">www.wago.com/769-103/000-036</a>
	<b>Item no.: 769-103/000-037</b> 1-conductor female plug; 4 mm <sup>2</sup> ; 3-pole	<a href="http://www.wago.com/769-103/000-037">www.wago.com/769-103/000-037</a>



**Item no.: 769-103/000-038**  
1-conductor female plug; 4 mm<sup>2</sup>; 3-pole

[www.wago.com/769-103/000-038](http://www.wago.com/769-103/000-038)



**Item no.: 769-103/000-039**  
1-conductor female plug; 4 mm<sup>2</sup>; 3-pole

[www.wago.com/769-103/000-039](http://www.wago.com/769-103/000-039)



**Item no.: 769-103/022-000**  
1-conductor female plug; angled; 4 mm<sup>2</sup>; 3-pole

[www.wago.com/769-103/022-000](http://www.wago.com/769-103/022-000)

**Item no.: 769-104**  
1-conductor female plug; 4 mm<sup>2</sup>; 4-pole

[www.wago.com/769-104](http://www.wago.com/769-104)

**Item no.: 769-104/000-006**  
1-conductor female plug; 4 mm<sup>2</sup>; 4-pole

[www.wago.com/769-104/000-006](http://www.wago.com/769-104/000-006)



**Item no.: 769-104/000-036**  
1-conductor female plug; 4 mm<sup>2</sup>; 4-pole

[www.wago.com/769-104/000-036](http://www.wago.com/769-104/000-036)



**Item no.: 769-104/000-037**  
1-conductor female plug; 4 mm<sup>2</sup>; 4-pole

[www.wago.com/769-104/000-037](http://www.wago.com/769-104/000-037)



**Item no.: 769-104/000-038**  
1-conductor female plug; 4 mm<sup>2</sup>; 4-pole

[www.wago.com/769-104/000-038](http://www.wago.com/769-104/000-038)



**Item no.: 769-104/000-039**  
1-conductor female plug; 4 mm<sup>2</sup>; 4-pole

[www.wago.com/769-104/000-039](http://www.wago.com/769-104/000-039)



**Item no.: 769-104/022-000**  
1-conductor female plug; angled; 4 mm<sup>2</sup>; 4-pole

[www.wago.com/769-104/022-000](http://www.wago.com/769-104/022-000)



**Item no.: 769-105**  
1-conductor female plug; 4 mm<sup>2</sup>; 5-pole

[www.wago.com/769-105](http://www.wago.com/769-105)



**Item no.: 769-105/000-006**  
1-conductor female plug; 4 mm<sup>2</sup>; 5-pole

[www.wago.com/769-105/000-006](http://www.wago.com/769-105/000-006)



**Item no.: 769-105/000-036**  
1-conductor female plug; 4 mm<sup>2</sup>; 5-pole

[www.wago.com/769-105/000-036](http://www.wago.com/769-105/000-036)



**Item no.: 769-105/000-037**  
1-conductor female plug; 4 mm<sup>2</sup>; 5-pole

[www.wago.com/769-105/000-037](http://www.wago.com/769-105/000-037)



**Item no.: 769-105/000-038**  
1-conductor female plug; 4 mm<sup>2</sup>; 5-pole

[www.wago.com/769-105/000-038](http://www.wago.com/769-105/000-038)



**Item no.: 769-105/000-039**  
1-conductor female plug; 4 mm<sup>2</sup>; 5-pole

[www.wago.com/769-105/000-039](http://www.wago.com/769-105/000-039)



**Item no.: 769-105/022-000**  
1-conductor female plug; angled; 4 mm<sup>2</sup>; 5-pole

[www.wago.com/769-105/022-000](http://www.wago.com/769-105/022-000)

**Item no.: 769-106**  
1-conductor female plug; 4 mm<sup>2</sup>; 6-pole

[www.wago.com/769-106](http://www.wago.com/769-106)

**Item no.: 769-106/000-006**  
1-conductor female plug; 4 mm<sup>2</sup>; 6-pole

[www.wago.com/769-106/000-006](http://www.wago.com/769-106/000-006)



**Item no.: 769-106/000-036**  
1-conductor female plug; 4 mm<sup>2</sup>; 6-pole

[www.wago.com/769-106/000-036](http://www.wago.com/769-106/000-036)



**Item no.: 769-106/000-037**  
1-conductor female plug; 4 mm<sup>2</sup>; 6-pole

[www.wago.com/769-106/000-037](http://www.wago.com/769-106/000-037)



**Item no.: 769-106/000-038**  
1-conductor female plug; 4 mm<sup>2</sup>; 6-pole

[www.wago.com/769-106/000-038](http://www.wago.com/769-106/000-038)



**Item no.: 769-106/000-039**  
1-conductor female plug; 4 mm<sup>2</sup>; 6-pole

[www.wago.com/769-106/000-039](http://www.wago.com/769-106/000-039)

**Item no.: 769-106/022-000**  
1-conductor female plug; angled; 4 mm<sup>2</sup>; 6-pole

[www.wago.com/769-106/022-000](http://www.wago.com/769-106/022-000)

**Item no.: 769-107**  
1-conductor female plug; 4 mm<sup>2</sup>; 7-pole

[www.wago.com/769-107](http://www.wago.com/769-107)

**Item no.: 769-107/000-006**  
1-conductor female plug; 4 mm<sup>2</sup>; 7-pole

[www.wago.com/769-107/000-006](http://www.wago.com/769-107/000-006)



**Item no.: 769-107/000-036**  
1-conductor female plug; 4 mm<sup>2</sup>; 7-pole

[www.wago.com/769-107/000-036](http://www.wago.com/769-107/000-036)



**Item no.: 769-107/000-037**  
1-conductor female plug; 4 mm<sup>2</sup>; 7-pole

[www.wago.com/769-107/000-037](http://www.wago.com/769-107/000-037)







**Item no.: 769-107/000-038**  
1-conductor female plug; 4 mm<sup>2</sup>; 7-pole

[www.wago.com/769-107/000-038](http://www.wago.com/769-107/000-038)



**Item no.: 769-107/000-039**  
1-conductor female plug; 4 mm<sup>2</sup>; 7-pole

[www.wago.com/769-107/000-039](http://www.wago.com/769-107/000-039)

<p><b>Item no.: 769-107/022-000</b> 1-conductor female plug; angled; 4 mm<sup>2</sup>; 7-pole</p>	<p><a href="http://www.wago.com/769-107/022-000">www.wago.com/769-107/022-000</a></p>	
<p><b>Item no.: 769-108</b> 1-conductor female plug; 4 mm<sup>2</sup>; 8-pole</p>	<p><a href="http://www.wago.com/769-108">www.wago.com/769-108</a></p>	
<p><b>Item no.: 769-108/000-006</b> 1-conductor female plug; 4 mm<sup>2</sup>; 8-pole</p>	<p><a href="http://www.wago.com/769-108/000-006">www.wago.com/769-108/000-006</a></p>	
<p><b>Item no.: 769-108/000-036</b> 1-conductor female plug; 4 mm<sup>2</sup>; 8-pole</p>	<p><a href="http://www.wago.com/769-108/000-036">www.wago.com/769-108/000-036</a></p>	
<p><b>Item no.: 769-108/000-037</b> 1-conductor female plug; 4 mm<sup>2</sup>; 8-pole</p>	<p><a href="http://www.wago.com/769-108/000-037">www.wago.com/769-108/000-037</a></p>	
<p><b>Item no.: 769-108/000-038</b> 1-conductor female plug; 4 mm<sup>2</sup>; 8-pole</p>	<p><a href="http://www.wago.com/769-108/000-038">www.wago.com/769-108/000-038</a></p>	
<p><b>Item no.: 769-108/000-039</b> 1-conductor female plug; 4 mm<sup>2</sup>; 8-pole</p>	<p><a href="http://www.wago.com/769-108/000-039">www.wago.com/769-108/000-039</a></p>	
<p><b>Item no.: 769-108/022-000</b> 1-conductor female plug; angled; 4 mm<sup>2</sup>; 8-pole</p>	<p><a href="http://www.wago.com/769-108/022-000">www.wago.com/769-108/022-000</a></p>	
<p><b>Item no.: 769-109</b> 1-conductor female plug; 4 mm<sup>2</sup>; 9-pole</p>	<p><a href="http://www.wago.com/769-109">www.wago.com/769-109</a></p>	
<p><b>Item no.: 769-109/000-006</b> 1-conductor female plug; 4 mm<sup>2</sup>; 9-pole</p>	<p><a href="http://www.wago.com/769-109/000-006">www.wago.com/769-109/000-006</a></p>	
	<p><b>Item no.: 769-109/000-036</b> 1-conductor female plug; 4 mm<sup>2</sup>; 9-pole</p>	<p><a href="http://www.wago.com/769-109/000-036">www.wago.com/769-109/000-036</a></p>
	<p><b>Item no.: 769-109/000-037</b> 1-conductor female plug; 4 mm<sup>2</sup>; 9-pole</p>	<p><a href="http://www.wago.com/769-109/000-037">www.wago.com/769-109/000-037</a></p>
	<p><b>Item no.: 769-109/000-038</b> 1-conductor female plug; 4 mm<sup>2</sup>; 9-pole</p>	<p><a href="http://www.wago.com/769-109/000-038">www.wago.com/769-109/000-038</a></p>
	<p><b>Item no.: 769-109/000-039</b> 1-conductor female plug; 4 mm<sup>2</sup>; 9-pole</p>	<p><a href="http://www.wago.com/769-109/000-039">www.wago.com/769-109/000-039</a></p>
<p><b>Item no.: 769-109/022-000</b> 1-conductor female plug; angled; 4 mm<sup>2</sup>; 9-pole</p>	<p><a href="http://www.wago.com/769-109/022-000">www.wago.com/769-109/022-000</a></p>	
<p><b>Item no.: 769-110</b></p>		





1-conductor female plug; 4 mm<sup>2</sup>; 10-pole

[www.wago.com/769-110](http://www.wago.com/769-110)

**Item no.: 769-110/000-006**

1-conductor female plug; 4 mm<sup>2</sup>; 10-pole

[www.wago.com/769-110/000-006](http://www.wago.com/769-110/000-006)

**Item no.: 769-110/000-036**

1-conductor female plug; 4 mm<sup>2</sup>; 10-pole

[www.wago.com/769-110/000-036](http://www.wago.com/769-110/000-036)

**Item no.: 769-110/000-037**

1-conductor female plug; 4 mm<sup>2</sup>; 10-pole

[www.wago.com/769-110/000-037](http://www.wago.com/769-110/000-037)

**Item no.: 769-110/000-038**

1-conductor female plug; 4 mm<sup>2</sup>; 10-pole

[www.wago.com/769-110/000-038](http://www.wago.com/769-110/000-038)

**Item no.: 769-110/000-039**

1-conductor female plug; 4 mm<sup>2</sup>; 10-pole

[www.wago.com/769-110/000-039](http://www.wago.com/769-110/000-039)

**Item no.: 769-110/022-000**

1-conductor female plug; angled; 4 mm<sup>2</sup>; 10-pole

[www.wago.com/769-110/022-000](http://www.wago.com/769-110/022-000)

**Item no.: 769-111**

1-conductor female plug; 4 mm<sup>2</sup>; 11-pole

[www.wago.com/769-111](http://www.wago.com/769-111)

**Item no.: 769-111/000-006**

1-conductor female plug; 4 mm<sup>2</sup>; 11-pole

[www.wago.com/769-111/000-006](http://www.wago.com/769-111/000-006)

**Item no.: 769-111/000-036**

1-conductor female plug; 4 mm<sup>2</sup>; 11-pole

[www.wago.com/769-111/000-036](http://www.wago.com/769-111/000-036)

**Item no.: 769-111/000-037**

1-conductor female plug; 4 mm<sup>2</sup>; 11-pole

[www.wago.com/769-111/000-037](http://www.wago.com/769-111/000-037)

**Item no.: 769-111/000-038**

1-conductor female plug; 4 mm<sup>2</sup>; 11-pole

[www.wago.com/769-111/000-038](http://www.wago.com/769-111/000-038)

**Item no.: 769-111/000-039**

1-conductor female plug; 4 mm<sup>2</sup>; 11-pole

[www.wago.com/769-111/000-039](http://www.wago.com/769-111/000-039)

**Item no.: 769-111/022-000**

1-conductor female plug; angled; 4 mm<sup>2</sup>; 11-pole

[www.wago.com/769-111/022-000](http://www.wago.com/769-111/022-000)

**Item no.: 769-112**

1-conductor female plug; 4 mm<sup>2</sup>; 12-pole

[www.wago.com/769-112](http://www.wago.com/769-112)

**Item no.: 769-112/000-006**

1-conductor female plug; 4 mm<sup>2</sup>; 12-pole

[www.wago.com/769-112/000-006](http://www.wago.com/769-112/000-006)



**Item no.: 769-112/000-036**  
1-conductor female plug; 4 mm<sup>2</sup>; 12-pole

[www.wago.com/769-112/000-036](http://www.wago.com/769-112/000-036)



**Item no.: 769-112/000-037**  
1-conductor female plug; 4 mm<sup>2</sup>; 12-pole

[www.wago.com/769-112/000-037](http://www.wago.com/769-112/000-037)



**Item no.: 769-112/000-038**  
1-conductor female plug; 4 mm<sup>2</sup>; 12-pole

[www.wago.com/769-112/000-038](http://www.wago.com/769-112/000-038)



**Item no.: 769-112/000-039**  
1-conductor female plug; 4 mm<sup>2</sup>; 12-pole

[www.wago.com/769-112/000-039](http://www.wago.com/769-112/000-039)

**Item no.: 769-112/022-000**  
1-conductor female plug; angled; 4 mm<sup>2</sup>; 12-pole

[www.wago.com/769-112/022-000](http://www.wago.com/769-112/022-000)

**Item no.: 769-113**  
1-conductor female plug; 4 mm<sup>2</sup>; 13-pole

[www.wago.com/769-113](http://www.wago.com/769-113)

**Item no.: 769-113/000-036**  
1-conductor female plug; 4 mm<sup>2</sup>; 13-pole

[www.wago.com/769-113/000-036](http://www.wago.com/769-113/000-036)

**Item no.: 769-113/000-037**  
1-conductor female plug; 4 mm<sup>2</sup>; 13-pole

[www.wago.com/769-113/000-037](http://www.wago.com/769-113/000-037)

**Item no.: 769-113/000-038**  
1-conductor female plug; 4 mm<sup>2</sup>; 13-pole

[www.wago.com/769-113/000-038](http://www.wago.com/769-113/000-038)

**Item no.: 769-113/000-039**  
1-conductor female plug; 4 mm<sup>2</sup>; 13-pole

[www.wago.com/769-113/000-039](http://www.wago.com/769-113/000-039)

**Item no.: 769-113/022-000**  
1-conductor female plug; angled; 4 mm<sup>2</sup>; 13-pole

[www.wago.com/769-113/022-000](http://www.wago.com/769-113/022-000)

**Item no.: 769-114**  
1-conductor female plug; 4 mm<sup>2</sup>; 14-pole

[www.wago.com/769-114](http://www.wago.com/769-114)

**Item no.: 769-114/000-006**  
1-conductor female plug; 4 mm<sup>2</sup>; 14-pole





[www.wago.com/769-114/000-006](http://www.wago.com/769-114/000-006)

**Item no.: 769-114/000-036**  
1-conductor female plug; 4 mm<sup>2</sup>; 14-pole

[www.wago.com/769-114/000-036](http://www.wago.com/769-114/000-036)

**Item no.: 769-114/000-037**  
1-conductor female plug; 4 mm<sup>2</sup>; 14-pole

[www.wago.com/769-114/000-037](http://www.wago.com/769-114/000-037)

	<b>Item no.: 769-114/000-038</b> 1-conductor female plug; 4 mm <sup>2</sup> ; 14-pole	<a href="http://www.wago.com/769-114/000-038">www.wago.com/769-114/000-038</a>
	<b>Item no.: 769-114/000-039</b> 1-conductor female plug; 4 mm <sup>2</sup> ; 14-pole	<a href="http://www.wago.com/769-114/000-039">www.wago.com/769-114/000-039</a>
	<b>Item no.: 769-114/022-000</b> 1-conductor female plug; angled; 4 mm <sup>2</sup> ; 14-pole	<a href="http://www.wago.com/769-114/022-000">www.wago.com/769-114/022-000</a>
	<b>Item no.: 769-115</b> 1-conductor female plug; 4 mm <sup>2</sup> ; 15-pole	<a href="http://www.wago.com/769-115">www.wago.com/769-115</a>
	<b>Item no.: 769-115/000-036</b> 1-conductor female plug; 4 mm <sup>2</sup> ; 15-pole	<a href="http://www.wago.com/769-115/000-036">www.wago.com/769-115/000-036</a>
	<b>Item no.: 769-115/000-037</b> 1-conductor female plug; 4 mm <sup>2</sup> ; 15-pole	<a href="http://www.wago.com/769-115/000-037">www.wago.com/769-115/000-037</a>
	<b>Item no.: 769-115/000-038</b> 1-conductor female plug; 4 mm <sup>2</sup> ; 15-pole	<a href="http://www.wago.com/769-115/000-038">www.wago.com/769-115/000-038</a>
	<b>Item no.: 769-115/000-039</b> 1-conductor female plug; 4 mm <sup>2</sup> ; 15-pole	<a href="http://www.wago.com/769-115/000-039">www.wago.com/769-115/000-039</a>
	<b>Item no.: 769-115/022-000</b> 1-conductor female plug; angled; 4 mm <sup>2</sup> ; 15-pole	<a href="http://www.wago.com/769-115/022-000">www.wago.com/769-115/022-000</a>
	<b>Item no.: 769-121</b> 2-conductor female connector; 4 mm <sup>2</sup> ; 1-pole	<a href="http://www.wago.com/769-121">www.wago.com/769-121</a>
	<b>Item no.: 769-121/000-016</b> 2-conductor female connector; 4 mm <sup>2</sup> ; 1-pole	<a href="http://www.wago.com/769-121/000-016">www.wago.com/769-121/000-016</a>
	<b>Item no.: 769-122</b> 2-conductor female connector; 4 mm <sup>2</sup> ; 2-pole	<a href="http://www.wago.com/769-122">www.wago.com/769-122</a>
	<b>Item no.: 769-123</b> 2-conductor female connector; 4 mm <sup>2</sup> ; 3-pole	<a href="http://www.wago.com/769-123">www.wago.com/769-123</a>
	<b>Item no.: 769-124</b> 2-conductor female connector; 4 mm <sup>2</sup> ; 4-pole	<a href="http://www.wago.com/769-124">www.wago.com/769-124</a>
	<b>Item no.: 769-125</b> 2-conductor female connector; 4 mm <sup>2</sup> ; 5-pole	<a href="http://www.wago.com/769-125">www.wago.com/769-125</a>
	<b>Item no.: 769-126</b> 2-conductor female connector; 4 mm <sup>2</sup> ; 6-pole	<a href="http://www.wago.com/769-126">www.wago.com/769-126</a>
	<b>Item no.: 769-127</b> 2-conductor female connector; 4 mm <sup>2</sup> ; 7-pole	<a href="http://www.wago.com/769-127">www.wago.com/769-127</a>

<b>Item no.: 769-128</b> 2-conductor female connector; 4 mm <sup>2</sup> ; 8-pole	<a href="http://www.wago.com/769-128">www.wago.com/769-128</a>
<b>Item no.: 769-129</b> 2-conductor female connector; 4 mm <sup>2</sup> ; 9-pole	<a href="http://www.wago.com/769-129">www.wago.com/769-129</a>
<b>Item no.: 769-130</b> 2-conductor female connector; 4 mm <sup>2</sup> ; 10-pole	<a href="http://www.wago.com/769-130">www.wago.com/769-130</a>
<b>Item no.: 769-131</b> 2-conductor female connector; 4 mm <sup>2</sup> ; 11-pole	<a href="http://www.wago.com/769-131">www.wago.com/769-131</a>
<b>Item no.: 769-132</b> 2-conductor female connector; 4 mm <sup>2</sup> ; 12-pole	<a href="http://www.wago.com/769-132">www.wago.com/769-132</a>
<b>Item no.: 769-133</b> 2-conductor female connector; 4 mm <sup>2</sup> ; 13-pole	<a href="http://www.wago.com/769-133">www.wago.com/769-133</a>
<b>Item no.: 769-134</b> 2-conductor female connector; 4 mm <sup>2</sup> ; 14-pole	<a href="http://www.wago.com/769-134">www.wago.com/769-134</a>
<b>Item no.: 769-135</b> 2-conductor female connector; 4 mm <sup>2</sup> ; 15-pole	<a href="http://www.wago.com/769-135">www.wago.com/769-135</a>







## assembling





**Item no.: 209-106**  
Mounting carrier; for isolated mounting on DIN 35 rails

[www.wago.com/209-106](http://www.wago.com/209-106)

## Marking accessories

	<b>Item no.: 2009-145</b> Mini-WSB Inline; for smartPRINTER; on reel; stretchable 5 - 5.2 mm; plain; snap-on type	<a href="http://www.wago.com/2009-145">www.wago.com/2009-145</a>
	<b>Item no.: 2009-145/000-002</b> Mini-WSB Inline; for smartPRINTER; on reel; stretchable 5 - 5.2 mm; plain; snap-on type	<a href="http://www.wago.com/2009-145/000-002">www.wago.com/2009-145/000-002</a>
	<b>Item no.: 2009-145/000-005</b> Mini-WSB Inline; for smartPRINTER; on reel; stretchable 5 - 5.2 mm; plain; snap-on type	<a href="http://www.wago.com/2009-145/000-005">www.wago.com/2009-145/000-005</a>
	<b>Item no.: 2009-145/000-006</b> Mini-WSB Inline; for smartPRINTER; on reel; stretchable 5 - 5.2 mm; plain; snap-on type	<a href="http://www.wago.com/2009-145/000-006">www.wago.com/2009-145/000-006</a>
	<b>Item no.: 2009-145/000-007</b> Mini-WSB Inline; for smartPRINTER; on reel; stretchable 5 - 5.2 mm; plain; snap-on type	<a href="http://www.wago.com/2009-145/000-007">www.wago.com/2009-145/000-007</a>
	<b>Item no.: 2009-145/000-012</b> Mini-WSB Inline; for smartPRINTER; on reel; stretchable 5 - 5.2 mm; plain; snap-on type	<a href="http://www.wago.com/2009-145/000-012">www.wago.com/2009-145/000-012</a>
	<b>Item no.: 2009-145/000-023</b> Mini-WSB Inline; for smartPRINTER; on reel; stretchable 5 - 5.2 mm; plain; snap-on type	<a href="http://www.wago.com/2009-145/000-023">www.wago.com/2009-145/000-023</a>

 **Item no.: 2009-145/000-024**  
Mini-WSB Inline; on reel; stretchable 5 - 5.2 mm; plain; snap-on type [www.wago.com/2009-145/000-024](http://www.wago.com/2009-145/000-024)

 **Item no.: 248-501**  
Miniature WSB Quick marking system; plain; Marker width 5 mm; 10 strips with 10 markers per card [www.wago.com/248-501](http://www.wago.com/248-501)

 **Item no.: 248-501/000-002**  
Mini-WSB marking card; as card; not stretchable; plain; snap-on type [www.wago.com/248-501/000-002](http://www.wago.com/248-501/000-002)

 **Item no.: 248-501/000-005**  
Mini-WSB marking card; as card; plain; snap-on type [www.wago.com/248-501/000-005](http://www.wago.com/248-501/000-005)

 **Item no.: 248-501/000-006**  
Mini-WSB marking card; as card; not stretchable; plain; snap-on type [www.wago.com/248-501/000-006](http://www.wago.com/248-501/000-006)

 **Item no.: 248-501/000-007**  
Mini-WSB marking card; as card; not stretchable; plain; snap-on type [www.wago.com/248-501/000-007](http://www.wago.com/248-501/000-007)

 **Item no.: 248-501/000-012**  
Mini-WSB marking card; as card; not stretchable; plain; snap-on type [www.wago.com/248-501/000-012](http://www.wago.com/248-501/000-012)

 **Item no.: 248-501/000-017**  
Mini-WSB marking card; as card; not stretchable; plain; snap-on type [www.wago.com/248-501/000-017](http://www.wago.com/248-501/000-017)

 **Item no.: 248-501/000-023**  
Mini-WSB marking card; as card; not stretchable; plain; snap-on type [www.wago.com/248-501/000-023](http://www.wago.com/248-501/000-023)

 **Item no.: 248-501/000-024**  
Mini-WSB marking card; as card; not stretchable; plain; snap-on type [www.wago.com/248-501/000-024](http://www.wago.com/248-501/000-024)

#### Protective Warning Marker

 **Item no.: 280-415**  
Protective warning marker; with high-voltage symbol, black; for 5 terminal blocks [www.wago.com/280-415](http://www.wago.com/280-415)



















#### Coding

















 **Item no.: 769-435**  
Coding pin; for coding of female plugs; for carrier terminal blocks / male connectors [www.wago.com/769-435](http://www.wago.com/769-435)

















#### Carrier rail

 **Item no.: 210-112**  
Steel carrier rail; 35 x 7.5 mm; 1 mm thick; 2 m long; slotted; according to EN 60715; "Hole width 25 mm [www.wago.com/210-112](http://www.wago.com/210-112)





 **Item no.: 210-113**  
Steel carrier rail; 35 x 7.5 mm; 1 mm thick; 2 m long; unslotted; according to EN 60715 [www.wago.com/210-113](http://www.wago.com/210-113)

	<b>Item no.: 210-114</b> Steel carrier rail; 35 x 15 mm; 1.5 mm thick; 2 m long; unslotted; similar to EN 60715	<a href="http://www.wago.com/210-114">www.wago.com/210-114</a>
	<b>Item no.: 210-115</b> Steel carrier rail; 35 x 7.5 mm; 1 mm thick; 2 m long; slotted; according to EN 60715; "Hole width 18 mm	<a href="http://www.wago.com/210-115">www.wago.com/210-115</a>
	<b>Item no.: 210-118</b> Steel carrier rail; 35 x 15 mm; 2.3 mm thick; 2 m long; unslotted; according to EN 60715	<a href="http://www.wago.com/210-118">www.wago.com/210-118</a>
	<b>Item no.: 210-196</b> Aluminum carrier rail; 35 x 8.2 mm; 1.6 mm thick; 2 m long; unslotted; similar to EN 60715	<a href="http://www.wago.com/210-196">www.wago.com/210-196</a>
	<b>Item no.: 210-197</b> Steel carrier rail; 35 x 15 mm; 1.5 mm thick; 2 m long; slotted; similar to EN 60715	<a href="http://www.wago.com/210-197">www.wago.com/210-197</a>
	<b>Item no.: 210-198</b> Copper carrier rail; 35 x 15 mm; 2.3 mm thick; 2 m long; unslotted; according to EN 60715	<a href="http://www.wago.com/210-198">www.wago.com/210-198</a>
	<b>Item no.: 210-504</b> Steel carrier rail; 35 x 7.5 mm; 1 mm thick; 2 m long; slotted; galvanized; according to EN 60715	<a href="http://www.wago.com/210-504">www.wago.com/210-504</a>
	<b>Item no.: 210-505</b> Steel carrier rail; 35 x 7.5 mm; 1 mm thick; 2 m long; unslotted; galvanized; according to EN 60715	<a href="http://www.wago.com/210-505">www.wago.com/210-505</a>
	<b>Item no.: 210-506</b> Steel carrier rail; 35 x 15 mm; 1.5 mm thick; 2 m long; unslotted; galvanized; similar to EN 60715	<a href="http://www.wago.com/210-506">www.wago.com/210-506</a>
	<b>Item no.: 210-508</b> Steel carrier rail; 35 x 15 mm; 1.5 mm thick; 2 m long; slotted; galvanized; similar to EN 60715	<a href="http://www.wago.com/210-508">www.wago.com/210-508</a>
<b>End plate</b>		
	<b>Item no.: 769-307</b> End and intermediate plate; 1.1 mm thick	<a href="http://www.wago.com/769-307">www.wago.com/769-307</a>
	<b>Item no.: 769-308</b> End and intermediate plate; 1.1 mm thick	<a href="http://www.wago.com/769-308">www.wago.com/769-308</a>
<b>General accessories</b>		
	<b>Item no.: 280-404</b> Test plug adapter; 5 mm wide; for test plug 210-137 (2.3 mm Ø); suitable for 1.5 mm <sup>2</sup> - 4 mm <sup>2</sup> tbs	<a href="http://www.wago.com/280-404">www.wago.com/280-404</a>
	<b>Item no.: 280-418</b> Test plug module; modular; suitable for all WAGO 280 and 780 Series rail-mounted terminal blocks with jumper slots in the current bar	<a href="http://www.wago.com/280-418">www.wago.com/280-418</a>
	<b>Item no.: 280-419</b> Spacer module; modular; bridging commoned terminal blocks	<a href="http://www.wago.com/280-419">www.wago.com/280-419</a>
	<b>Item no.: 769-438</b> Pin cover; with marker slot for miniature WSB	<a href="http://www.wago.com/769-438">www.wago.com/769-438</a>
	<b>Item no.: 769-439</b> Pin cover; with marker slot for miniature WSB	<a href="http://www.wago.com/769-439">www.wago.com/769-439</a>
	<b>Item no.: 769-501</b> Start module for 1-conductor female connector; with integrated end plate; 4 mm <sup>2</sup> ; 1-pole	<a href="http://www.wago.com/769-501">www.wago.com/769-501</a>

	<b>Item no.: 769-501/000-006</b> Start module for 1-conductor female connector; 4 mm <sup>2</sup> ; 1-pole	<a href="http://www.wago.com/769-501/000-006">www.wago.com/769-501/000-006</a>
	<b>Item no.: 769-501/000-016</b> Start module for 1-conductor female connector; with integrated end plate; 4 mm <sup>2</sup> ; 1-pole	<a href="http://www.wago.com/769-501/000-016">www.wago.com/769-501/000-016</a>
	<b>Item no.: 769-502</b> Center module for 1-conductor female connector; 4 mm <sup>2</sup> ; 1-pole	<a href="http://www.wago.com/769-502">www.wago.com/769-502</a>
	<b>Item no.: 769-502/000-006</b> Center module for 1-conductor female connector; 4 mm <sup>2</sup> ; 1-pole	<a href="http://www.wago.com/769-502/000-006">www.wago.com/769-502/000-006</a>
	<b>Item no.: 769-502/000-016</b> 1-conductor center module; codable; can be commoned with miniature adjacent jumpers; 1-pole	<a href="http://www.wago.com/769-502/000-016">www.wago.com/769-502/000-016</a>
	<b>Item no.: 769-503</b> End module for 1-conductor female connector; 4 mm <sup>2</sup> ; 1-pole	<a href="http://www.wago.com/769-503">www.wago.com/769-503</a>
	<b>Item no.: 769-503/000-006</b> End module for 1-conductor female connector; 4 mm <sup>2</sup> ; 1-pole	<a href="http://www.wago.com/769-503/000-006">www.wago.com/769-503/000-006</a>
	<b>Item no.: 769-503/000-016</b> End module for 1-conductor female connector; 4 mm <sup>2</sup> ; 1-pole	<a href="http://www.wago.com/769-503/000-016">www.wago.com/769-503/000-016</a>
	<b>Item no.: 769-504</b> 2-conductor base module; with integrated end plate; codable; can be commoned with adjacent jumpers and staggered jumpers; 1-pole	<a href="http://www.wago.com/769-504">www.wago.com/769-504</a>
	<b>Item no.: 769-504/000-006</b> Start module for 2-conductor female connector; with integrated end plate; 4 mm <sup>2</sup> ; 1-pole	<a href="http://www.wago.com/769-504/000-006">www.wago.com/769-504/000-006</a>
	<b>Item no.: 769-504/000-016</b> Start module for 2-conductor female connector; 4 mm <sup>2</sup> ; 1-pole	<a href="http://www.wago.com/769-504/000-016">www.wago.com/769-504/000-016</a>
	<b>Item no.: 769-505</b> Center module for 2-conductor female connector; 4 mm <sup>2</sup> ; 1-pole	<a href="http://www.wago.com/769-505">www.wago.com/769-505</a>
	<b>Item no.: 769-505/000-006</b> Center module for 2-conductor female connector; 4 mm <sup>2</sup> ; 1-pole	<a href="http://www.wago.com/769-505/000-006">www.wago.com/769-505/000-006</a>
	<b>Item no.: 769-505/000-016</b> Center module for 2-conductor female connector; 4 mm <sup>2</sup> ; 1-pole	<a href="http://www.wago.com/769-505/000-016">www.wago.com/769-505/000-016</a>
	<b>Item no.: 769-506</b> 2-conductor end module; codable; can be commoned with adjacent jumpers and staggered jumpers; 1-	<a href="http://www.wago.com/769-506">www.wago.com/769-506</a>
	<b>Item no.: 769-506/000-006</b> End module for 2-conductor female connector; 4 mm <sup>2</sup> ; 1-pole	<a href="http://www.wago.com/769-506/000-006">www.wago.com/769-506/000-006</a>

	<b>Item no.: 769-506/000-016</b> End module for 2-conductor female connector; 4 mm <sup>2</sup> ; 1-pole	<a href="http://www.wago.com/769-506/000-016">www.wago.com/769-506/000-016</a>
	<b>Item no.: 769-512</b> Start module for 1-conductor female connector; angled; 4 mm <sup>2</sup> ; 1-pole	<a href="http://www.wago.com/769-512">www.wago.com/769-512</a>
	<b>Item no.: 769-512/000-006</b> Start module for 1-conductor female connector; angled; 4 mm <sup>2</sup> ; 1-pole	<a href="http://www.wago.com/769-512/000-006">www.wago.com/769-512/000-006</a>
	<b>Item no.: 769-512/000-016</b> Start module for 1-conductor female connector; angled; 4 mm <sup>2</sup> ; 1-pole	<a href="http://www.wago.com/769-512/000-016">www.wago.com/769-512/000-016</a>
	<b>Item no.: 769-513</b> Center module for 1-conductor female connector; angled; 4 mm <sup>2</sup> ; 1-pole	<a href="http://www.wago.com/769-513">www.wago.com/769-513</a>
	<b>Item no.: 769-513/000-006</b> 1-conductor center module; angled; codable; 1-pole	<a href="http://www.wago.com/769-513/000-006">www.wago.com/769-513/000-006</a>
	<b>Item no.: 769-513/000-016</b> 1-conductor center module; angled; codable; 1-pole	<a href="http://www.wago.com/769-513/000-016">www.wago.com/769-513/000-016</a>
	<b>Item no.: 769-515</b> 1-conductor end module; angled; codable; 1-pole	<a href="http://www.wago.com/769-515">www.wago.com/769-515</a>
	<b>Item no.: 769-515/000-006</b> 1-conductor end module; angled; codable; 1-pole	<a href="http://www.wago.com/769-515/000-006">www.wago.com/769-515/000-006</a>
	<b>Item no.: 769-515/000-016</b> 1-conductor end module; angled; codable; 1-pole	<a href="http://www.wago.com/769-515/000-016">www.wago.com/769-515/000-016</a>
<b>ferrule</b>		
	<b>Item no.: 216-101</b> Ferrule; Sleeve for 0.5 mm <sup>2</sup> / AWG 22; uninsulated; electro-tin plated	<a href="http://www.wago.com/216-101">www.wago.com/216-101</a>
	<b>Item no.: 216-102</b> Ferrule; Sleeve for 0.75 mm <sup>2</sup> / AWG 20; uninsulated; electro-tin plated	<a href="http://www.wago.com/216-102">www.wago.com/216-102</a>
	<b>Item no.: 216-103</b> Ferrule; Sleeve for 1 mm <sup>2</sup> / AWG 18; uninsulated; electro-tin plated	<a href="http://www.wago.com/216-103">www.wago.com/216-103</a>
	<b>Item no.: 216-104</b> Ferrule; Sleeve for 1.5 mm <sup>2</sup> / AWG 16; uninsulated; electro-tin plated	<a href="http://www.wago.com/216-104">www.wago.com/216-104</a>
	<b>Item no.: 216-201</b> Ferrule; Sleeve for 0.5 mm <sup>2</sup> / AWG 22; insulated; electro-tin plated	<a href="http://www.wago.com/216-201">www.wago.com/216-201</a>
	<b>Item no.: 216-202</b> Ferrule; Sleeve for 0.75 mm <sup>2</sup> / AWG 20; insulated; electro-tin plated	<a href="http://www.wago.com/216-202">www.wago.com/216-202</a>
	<b>Item no.: 216-203</b> Ferrule; Sleeve for 1 mm <sup>2</sup> / AWG 18; insulated; electro-tin plated	<a href="http://www.wago.com/216-203">www.wago.com/216-203</a>



	<b>Item no.: 216-204</b> Ferrule; Sleeve for 1.5 mm <sup>2</sup> / AWG 16; insulated; electro-tin plated	<a href="http://www.wago.com/216-204">www.wago.com/216-204</a>
	<b>Item no.: 216-206</b> Ferrule; Sleeve for 2.5 mm <sup>2</sup> / AWG 14; insulated; electro-tin plated	<a href="http://www.wago.com/216-206">www.wago.com/216-206</a>
	<b>Item no.: 216-301</b> Ferrule; Sleeve for 0.25 mm <sup>2</sup> / AWG 24; insulated; electro-tin plated	<a href="http://www.wago.com/216-301">www.wago.com/216-301</a>
	<b>Item no.: 216-302</b> Ferrule; Sleeve for 0.34 mm <sup>2</sup> / AWG 24; insulated; electro-tin plated	<a href="http://www.wago.com/216-302">www.wago.com/216-302</a>

## Downloads

### Documentation

#### Bid Text

769-176	Oct 18, 2017	DOC 25.1 kB	Download
---------	--------------	----------------	----------

## smartDATA

### CAD data

3D Download 769-176	URL	Download
---------------------	-----	----------

## Product family

### X-COM

[Learn more about the product family.](#)

[Show all products from the family](#)

Subject to changes.