

Data sheet | Item number: 769-202

2-pin disconnect carrier terminal block; with 2 jumper positions; for DIN-rail
35 x 15 and 35 x 7.5

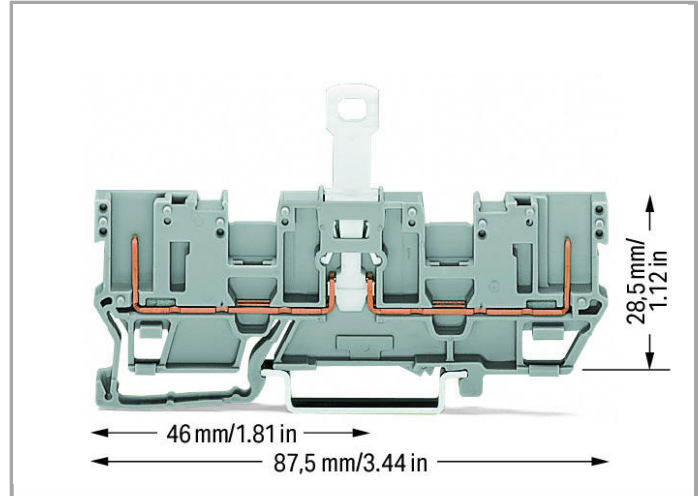

www.wago.com/769-202

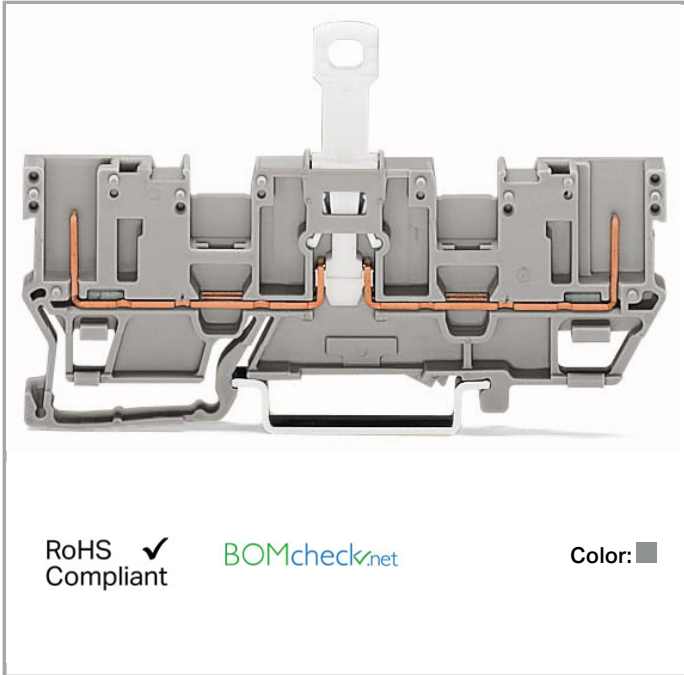

RoHS Compliant

BOMcheck.net

Color: ■

Data

Electrical data

Ratings per IEC/EN 60664-1

Rated voltage (III / 3)	400 V
Rated impulse voltage (III / 3)	6 kV
Rated current	16 A
Legend (ratings)	(III / 3) ≙ Overvoltage category III / Pollution degree 3

Connection data

Total number of potentials	1
Number of levels	1
Type of wiring	Front-entry wiring

Geometrical Data

Width	5 mm / 0.197 inch
Height from upper-edge of DIN-35 rail	28.5 mm / 1.122 inch
Depth	87.5 mm / 3.445 inch

Mechanical data

Design	horizontal
Type of mounting	DIN-35 rail
Marking level	Center marking

Material Data



Color	gray
Insulating material	Polyamide 66 (PA 66)
Fire load	0.179 MJ
Weight	8.17 g

Commercial data



Country of origin	DE
GTIN	4044918630108
Customs Tariff No.	85365080990
Product Group	18 (X-COM-System)

Approvals / Certificates

Country specific Approvals

Logo	Approval	Certificate name
	CCA DEKRA Certification B.V.	NTR NL-7626
	CSA DEKRA Certification B.V.	1101144
	KEMA/KEUR DEKRA Certification B.V.	2190419.01

Ship Approvals

Logo	Approval	Certificate name
	ABS American Bureau of Shipping	14-HG1293677-PDA
	LR Lloyds Register	91/20112 (E9)

UL-Approvals

Logo	Approval	Certificate name
	UR Underwriters Laboratories Inc.	E45171
	UR Underwriters Laboratories Inc.	E45172

Compatible products

assembling

	Item no.: 209-106 Mounting carrier; for isolated mounting on DIN 35 rails	www.wago.com/209-106
--	--	--















Carrier rail

	Item no.: 210-112 Steel carrier rail; 35 x 7.5 mm; 1 mm thick; 2 m long; slotted; according to EN 60715; "Hole width 25 mm	www.wago.com/210-112
	Item no.: 210-113 Steel carrier rail; 35 x 7.5 mm; 1 mm thick; 2 m long; unslotted; according to EN 60715	www.wago.com/210-113
	Item no.: 210-114 Steel carrier rail; 35 x 15 mm; 1.5 mm thick; 2 m long; unslotted; similar to EN 60715	www.wago.com/210-114
	Item no.: 210-115 Steel carrier rail; 35 x 7.5 mm; 1 mm thick; 2 m long; slotted; according to EN 60715; "Hole width 18 mm	www.wago.com/210-115
	Item no.: 210-118 Steel carrier rail; 35 x 15 mm; 2.3 mm thick; 2 m long; unslotted; according to EN 60715	www.wago.com/210-118
	Item no.: 210-196 Aluminum carrier rail; 35 x 8.2 mm; 1.6 mm thick; 2 m long; unslotted; similar to EN 60715	www.wago.com/210-196
	Item no.: 210-197 Steel carrier rail; 35 x 15 mm; 1.5 mm thick; 2 m long; slotted; similar to EN 60715	www.wago.com/210-197
	Item no.: 210-198 Copper carrier rail; 35 x 15 mm; 2.3 mm thick; 2 m long; unslotted; according to EN 60715	www.wago.com/210-198
	Item no.: 210-504 Steel carrier rail; 35 x 7.5 mm; 1 mm thick; 2 m long; slotted; galvanized; according to EN 60715	www.wago.com/210-504
	Item no.: 210-505 Steel carrier rail; 35 x 7.5 mm; 1 mm thick; 2 m long; unslotted; galvanized; according to EN 60715	www.wago.com/210-505
	Item no.: 210-506 Steel carrier rail; 35 x 15 mm; 1.5 mm thick; 2 m long; unslotted; galvanized; similar to EN 60715	www.wago.com/210-506

**Item no.: 210-508**

Steel carrier rail; 35 x 15 mm; 1.5 mm thick; 2 m long; slotted; galvanized; similar to EN 60715

www.wago.com/210-508**Marking accessories**

	Item no.: 2009-145 Mini-WSB Inline; for smartPRINTER; on reel; stretchable 5 - 5.2 mm; plain; snap-on type	www.wago.com/2009-145
	Item no.: 2009-145/000-002 Mini-WSB Inline; for smartPRINTER; on reel; stretchable 5 - 5.2 mm; plain; snap-on type	www.wago.com/2009-145/000-002
	Item no.: 2009-145/000-005 Mini-WSB Inline; for smartPRINTER; on reel; stretchable 5 - 5.2 mm; plain; snap-on type	www.wago.com/2009-145/000-005
	Item no.: 2009-145/000-006 Mini-WSB Inline; for smartPRINTER; on reel; stretchable 5 - 5.2 mm; plain; snap-on type	www.wago.com/2009-145/000-006
	Item no.: 2009-145/000-007 Mini-WSB Inline; for smartPRINTER; on reel; stretchable 5 - 5.2 mm; plain; snap-on type	www.wago.com/2009-145/000-007
	Item no.: 2009-145/000-012 Mini-WSB Inline; for smartPRINTER; on reel; stretchable 5 - 5.2 mm; plain; snap-on type	www.wago.com/2009-145/000-012
	Item no.: 2009-145/000-023 Mini-WSB Inline; for smartPRINTER; on reel; stretchable 5 - 5.2 mm; plain; snap-on type	www.wago.com/2009-145/000-023
	Item no.: 2009-145/000-024 Mini-WSB Inline; on reel; stretchable 5 - 5.2 mm; plain; snap-on type	www.wago.com/2009-145/000-024
	Item no.: 248-501 Miniature WSB Quick marking system; plain; Marker width 5 mm; 10 strips with 10 markers per card	www.wago.com/248-501
	Item no.: 248-501/000-002 Mini-WSB marking card; as card; not stretchable; plain; snap-on type	www.wago.com/248-501/000-002
	Item no.: 248-501/000-005 Mini-WSB marking card; as card; plain; snap-on type	www.wago.com/248-501/000-005
	Item no.: 248-501/000-006 Mini-WSB marking card; as card; not stretchable; plain; snap-on type	www.wago.com/248-501/000-006
	Item no.: 248-501/000-007 Mini-WSB marking card; as card; not stretchable; plain; snap-on type	www.wago.com/248-501/000-007
	Item no.: 248-501/000-012 Mini-WSB marking card; as card; not stretchable; plain; snap-on type	www.wago.com/248-501/000-012



Item no.: 248-501/000-017
Mini-WSB marking card; as card; not stretchable; plain; snap-on type

www.wago.com/248-501/000-017



Item no.: 248-501/000-023
Mini-WSB marking card; as card; not stretchable; plain; snap-on type

www.wago.com/248-501/000-023



Item no.: 248-501/000-024
Mini-WSB marking card; as card; not stretchable; plain; snap-on type

www.wago.com/248-501/000-024

check



Item no.: 210-137
Test plug; 2.3 mm Ø; with 500 mm cable

www.wago.com/210-137

Female plug



Item no.: 769-101
1-conductor female plug; 4 mm²; 1-pole

www.wago.com/769-101



Item no.: 769-101/000-006
1-conductor female plug; 4 mm²; 1-pole

www.wago.com/769-101/000-006



Item no.: 769-101/000-016
1-conductor female plug; 4 mm²; 1-pole

www.wago.com/769-101/000-016



Item no.: 769-101/022-000
1-conductor female plug; angled; 4 mm²; 1-pole

www.wago.com/769-101/022-000



Item no.: 769-101/022-016
1-conductor female plug; angled; 4 mm²; 1-pole

www.wago.com/769-101/022-016



Item no.: 769-102
1-conductor female plug; 4 mm²; 2-pole

www.wago.com/769-102

Item no.: 769-102/000-006
1-conductor female plug; 4 mm²; 2-pole

www.wago.com/769-102/000-006

Item no.: 769-102/000-036
1-conductor female plug; 4 mm²; 2-pole

www.wago.com/769-102/000-036

Item no.: 769-102/000-037
1-conductor female plug; 4 mm²; 2-pole











www.wago.com/769-102/000-037











Item no.: 769-102/022-000
1-conductor female plug; angled; 4 mm²; 2-pole

www.wago.com/769-102/022-000

Item no.: 769-103

	1-conductor female plug; 4 mm ² ; 3-pole	www.wago.com/769-103
	Item no.: 769-103/000-006 1-conductor female plug; 4 mm ² ; 3-pole	www.wago.com/769-103/000-006
	Item no.: 769-103/000-036 1-conductor female plug; 4 mm ² ; 3-pole	www.wago.com/769-103/000-036
	Item no.: 769-103/000-037 1-conductor female plug; 4 mm ² ; 3-pole	www.wago.com/769-103/000-037
	Item no.: 769-103/000-038 1-conductor female plug; 4 mm ² ; 3-pole	www.wago.com/769-103/000-038
	Item no.: 769-103/000-039 1-conductor female plug; 4 mm ² ; 3-pole	www.wago.com/769-103/000-039
	Item no.: 769-103/022-000 1-conductor female plug; angled; 4 mm ² ; 3-pole	www.wago.com/769-103/022-000
	Item no.: 769-104 1-conductor female plug; 4 mm ² ; 4-pole	www.wago.com/769-104
	Item no.: 769-104/000-006 1-conductor female plug; 4 mm ² ; 4-pole	www.wago.com/769-104/000-006
	Item no.: 769-104/000-036 1-conductor female plug; 4 mm ² ; 4-pole	www.wago.com/769-104/000-036
	Item no.: 769-104/000-037 1-conductor female plug; 4 mm ² ; 4-pole	www.wago.com/769-104/000-037
	Item no.: 769-104/000-038 1-conductor female plug; 4 mm ² ; 4-pole	www.wago.com/769-104/000-038
	Item no.: 769-104/000-039 1-conductor female plug; 4 mm ² ; 4-pole	www.wago.com/769-104/000-039
	Item no.: 769-104/022-000 1-conductor female plug; angled; 4 mm ² ; 4-pole	www.wago.com/769-104/022-000
	Item no.: 769-105 1-conductor female plug; 4 mm ² ; 5-pole	www.wago.com/769-105
	Item no.: 769-105/000-006 1-conductor female plug; 4 mm ² ; 5-pole	www.wago.com/769-105/000-006



	Item no.: 769-105/000-036 1-conductor female plug; 4 mm ² ; 5-pole	www.wago.com/769-105/000-036
	Item no.: 769-105/000-037 1-conductor female plug; 4 mm ² ; 5-pole	www.wago.com/769-105/000-037
	Item no.: 769-105/000-038 1-conductor female plug; 4 mm ² ; 5-pole	www.wago.com/769-105/000-038
	Item no.: 769-105/000-039 1-conductor female plug; 4 mm ² ; 5-pole	www.wago.com/769-105/000-039
	Item no.: 769-105/022-000 1-conductor female plug; angled; 4 mm ² ; 5-pole	www.wago.com/769-105/022-000
	Item no.: 769-106 1-conductor female plug; 4 mm ² ; 6-pole	www.wago.com/769-106
	Item no.: 769-106/000-006 1-conductor female plug; 4 mm ² ; 6-pole	www.wago.com/769-106/000-006
	Item no.: 769-106/000-036 1-conductor female plug; 4 mm ² ; 6-pole	www.wago.com/769-106/000-036
	Item no.: 769-106/000-037 1-conductor female plug; 4 mm ² ; 6-pole	www.wago.com/769-106/000-037
	Item no.: 769-106/000-038 1-conductor female plug; 4 mm ² ; 6-pole	www.wago.com/769-106/000-038
	Item no.: 769-106/000-039 1-conductor female plug; 4 mm ² ; 6-pole	www.wago.com/769-106/000-039
	Item no.: 769-106/022-000 1-conductor female plug; angled; 4 mm ² ; 6-pole	www.wago.com/769-106/022-000
	Item no.: 769-107 1-conductor female plug; 4 mm ² ; 7-pole	www.wago.com/769-107
	Item no.: 769-107/000-006 1-conductor female plug; 4 mm ² ; 7-pole	www.wago.com/769-107/000-006



Item no.: 769-107/000-036
1-conductor female plug; 4 mm²; 7-pole

www.wago.com/769-107/000-036



Item no.: 769-107/000-037
1-conductor female plug; 4 mm²; 7-pole

www.wago.com/769-107/000-037



Item no.: 769-107/000-038
1-conductor female plug; 4 mm²; 7-pole

www.wago.com/769-107/000-038



Item no.: 769-107/000-039
1-conductor female plug; 4 mm²; 7-pole

www.wago.com/769-107/000-039

Item no.: 769-107/022-000
1-conductor female plug; angled; 4 mm²; 7-pole

www.wago.com/769-107/022-000

Item no.: 769-108
1-conductor female plug; 4 mm²; 8-pole

www.wago.com/769-108

Item no.: 769-108/000-006
1-conductor female plug; 4 mm²; 8-pole

www.wago.com/769-108/000-006

Item no.: 769-108/000-036
1-conductor female plug; 4 mm²; 8-pole

www.wago.com/769-108/000-036

Item no.: 769-108/000-037
1-conductor female plug; 4 mm²; 8-pole

www.wago.com/769-108/000-037

Item no.: 769-108/000-038
1-conductor female plug; 4 mm²; 8-pole

www.wago.com/769-108/000-038

Item no.: 769-108/000-039
1-conductor female plug; 4 mm²; 8-pole

www.wago.com/769-108/000-039

Item no.: 769-108/022-000
1-conductor female plug; angled; 4 mm²; 8-pole

www.wago.com/769-108/022-000

Item no.: 769-109
1-conductor female plug; 4 mm²; 9-pole

www.wago.com/769-109

Item no.: 769-109/000-006
1-conductor female plug; 4 mm²; 9-pole

www.wago.com/769-109/000-006



Item no.: 769-109/000-036
1-conductor female plug; 4 mm²; 9-pole

www.wago.com/769-109/000-036



Item no.: 769-109/000-037
1-conductor female plug; 4 mm²; 9-pole

www.wago.com/769-109/000-037



Item no.: 769-109/000-038
1-conductor female plug; 4 mm²; 9-pole

www.wago.com/769-109/000-038



Item no.: 769-109/000-039
1-conductor female plug; 4 mm²; 9-pole

www.wago.com/769-109/000-039

Item no.: 769-109/022-000
1-conductor female plug; angled; 4 mm²; 9-pole

www.wago.com/769-109/022-000

Item no.: 769-110
1-conductor female plug; 4 mm²; 10-pole

www.wago.com/769-110

Item no.: 769-110/000-006
1-conductor female plug; 4 mm²; 10-pole

www.wago.com/769-110/000-006

Item no.: 769-110/000-036
1-conductor female plug; 4 mm²; 10-pole

www.wago.com/769-110/000-036

Item no.: 769-110/000-037
1-conductor female plug; 4 mm²; 10-pole

www.wago.com/769-110/000-037

Item no.: 769-110/000-038
1-conductor female plug; 4 mm²; 10-pole

www.wago.com/769-110/000-038

Item no.: 769-110/000-039
1-conductor female plug; 4 mm²; 10-pole

www.wago.com/769-110/000-039

Item no.: 769-110/022-000
1-conductor female plug; angled; 4 mm²; 10-pole

www.wago.com/769-110/022-000

Item no.: 769-111
1-conductor female plug; 4 mm²; 11-pole

www.wago.com/769-111

Item no.: 769-111/000-006
1-conductor female plug; 4 mm²; 11-pole





www.wago.com/769-111/000-006

Item no.: 769-111/000-036
1-conductor female plug; 4 mm²; 11-pole

www.wago.com/769-111/000-036

Item no.: 769-111/000-037
1-conductor female plug; 4 mm²; 11-pole

www.wago.com/769-111/000-037

	Item no.: 769-111/000-038 1-conductor female plug; 4 mm ² ; 11-pole	www.wago.com/769-111/000-038
	Item no.: 769-111/000-039 1-conductor female plug; 4 mm ² ; 11-pole	www.wago.com/769-111/000-039
	Item no.: 769-111/022-000 1-conductor female plug; angled; 4 mm ² ; 11-pole	www.wago.com/769-111/022-000
	Item no.: 769-112 1-conductor female plug; 4 mm ² ; 12-pole	www.wago.com/769-112
	Item no.: 769-112/000-006 1-conductor female plug; 4 mm ² ; 12-pole	www.wago.com/769-112/000-006
	Item no.: 769-112/000-036 1-conductor female plug; 4 mm ² ; 12-pole	www.wago.com/769-112/000-036
	Item no.: 769-112/000-037 1-conductor female plug; 4 mm ² ; 12-pole	www.wago.com/769-112/000-037
	Item no.: 769-112/000-038 1-conductor female plug; 4 mm ² ; 12-pole	www.wago.com/769-112/000-038
	Item no.: 769-112/000-039 1-conductor female plug; 4 mm ² ; 12-pole	www.wago.com/769-112/000-039
	Item no.: 769-112/022-000 1-conductor female plug; angled; 4 mm ² ; 12-pole	www.wago.com/769-112/022-000
	Item no.: 769-113 1-conductor female plug; 4 mm ² ; 13-pole	www.wago.com/769-113
	Item no.: 769-113/000-036 1-conductor female plug; 4 mm ² ; 13-pole	www.wago.com/769-113/000-036
	Item no.: 769-113/000-037 1-conductor female plug; 4 mm ² ; 13-pole	www.wago.com/769-113/000-037
	Item no.: 769-113/000-038 1-conductor female plug; 4 mm ² ; 13-pole	www.wago.com/769-113/000-038
	Item no.: 769-113/000-039 1-conductor female plug; 4 mm ² ; 13-pole	www.wago.com/769-113/000-039

Item no.: 769-113/022-000 1-conductor female plug; angled; 4 mm ² ; 13-pole	www.wago.com/769-113/022-000
Item no.: 769-114 1-conductor female plug; 4 mm ² ; 14-pole	www.wago.com/769-114
Item no.: 769-114/000-006 1-conductor female plug; 4 mm ² ; 14-pole	www.wago.com/769-114/000-006
Item no.: 769-114/000-036 1-conductor female plug; 4 mm ² ; 14-pole	www.wago.com/769-114/000-036
Item no.: 769-114/000-037 1-conductor female plug; 4 mm ² ; 14-pole	www.wago.com/769-114/000-037
Item no.: 769-114/000-038 1-conductor female plug; 4 mm ² ; 14-pole	www.wago.com/769-114/000-038
Item no.: 769-114/000-039 1-conductor female plug; 4 mm ² ; 14-pole	www.wago.com/769-114/000-039
Item no.: 769-114/022-000 1-conductor female plug; angled; 4 mm ² ; 14-pole	www.wago.com/769-114/022-000
Item no.: 769-115 1-conductor female plug; 4 mm ² ; 15-pole	www.wago.com/769-115
Item no.: 769-115/000-036 1-conductor female plug; 4 mm ² ; 15-pole	www.wago.com/769-115/000-036
Item no.: 769-115/000-037 1-conductor female plug; 4 mm ² ; 15-pole	www.wago.com/769-115/000-037
Item no.: 769-115/000-038 1-conductor female plug; 4 mm ² ; 15-pole	www.wago.com/769-115/000-038
Item no.: 769-115/000-039 1-conductor female plug; 4 mm ² ; 15-pole	www.wago.com/769-115/000-039
Item no.: 769-115/022-000 1-conductor female plug; angled; 4 mm ² ; 15-pole	www.wago.com/769-115/022-000
 Item no.: 769-121 2-conductor female connector; 4 mm ² ; 1-pole	www.wago.com/769-121
Item no.: 769-121/000-016 2-conductor female connector; 4 mm ² ; 1-pole	www.wago.com/769-121/000-016

































	Item no.: 769-122 2-conductor female connector; 4 mm ² ; 2-pole	www.wago.com/769-122
	Item no.: 769-123 2-conductor female connector; 4 mm ² ; 3-pole	www.wago.com/769-123
	Item no.: 769-124 2-conductor female connector; 4 mm ² ; 4-pole	www.wago.com/769-124
	Item no.: 769-125 2-conductor female connector; 4 mm ² ; 5-pole	www.wago.com/769-125
	Item no.: 769-126 2-conductor female connector; 4 mm ² ; 6-pole	www.wago.com/769-126
	Item no.: 769-127 2-conductor female connector; 4 mm ² ; 7-pole	www.wago.com/769-127
	Item no.: 769-128 2-conductor female connector; 4 mm ² ; 8-pole	www.wago.com/769-128
	Item no.: 769-129 2-conductor female connector; 4 mm ² ; 9-pole	www.wago.com/769-129
	Item no.: 769-130 2-conductor female connector; 4 mm ² ; 10-pole	www.wago.com/769-130
	Item no.: 769-131 2-conductor female connector; 4 mm ² ; 11-pole	www.wago.com/769-131
	Item no.: 769-132 2-conductor female connector; 4 mm ² ; 12-pole	www.wago.com/769-132
	Item no.: 769-133 2-conductor female connector; 4 mm ² ; 13-pole	www.wago.com/769-133
	Item no.: 769-134 2-conductor female connector; 4 mm ² ; 14-pole	www.wago.com/769-134
	Item no.: 769-135 2-conductor female connector; 4 mm ² ; 15-pole	www.wago.com/769-135

General accessories



	Item no.: 280-404 Test plug adapter; 5 mm wide; for test plug 210-137 (2.3 mm Ø); suitable for 1.5 mm ² - 4 mm ² tbs	www.wago.com/280-404
	Item no.: 280-418 Test plug module; modular; suitable for all WAGO 280 and 780 Series rail-mounted terminal blocks with jumper slots in the current bar	www.wago.com/280-418
	Item no.: 280-419 Spacer module; modular; bridging commoned terminal blocks	www.wago.com/280-419
	Item no.: 709-170 Disconnect lock; for disconnect tab used on 280/281 and 769 Series disconnect terminal blocks	www.wago.com/709-170

	Item no.: 769-438 Pin cover; with marker slot for miniature WSB	www.wago.com/769-438
	Item no.: 769-439 Pin cover; with marker slot for miniature WSB	www.wago.com/769-439
	Item no.: 769-501 Start module for 1-conductor female connector; with integrated end plate; 4 mm ² ; 1-pole	www.wago.com/769-501
	Item no.: 769-501/000-006 Start module for 1-conductor female connector; 4 mm ² ; 1-pole	www.wago.com/769-501/000-006
	Item no.: 769-501/000-016 Start module for 1-conductor female connector; with integrated end plate; 4 mm ² ; 1-pole	www.wago.com/769-501/000-016
	Item no.: 769-502 Center module for 1-conductor female connector; 4 mm ² ; 1-pole	www.wago.com/769-502
	Item no.: 769-502/000-006 Center module for 1-conductor female connector; 4 mm ² ; 1-pole	www.wago.com/769-502/000-006
	Item no.: 769-502/000-016 1-conductor center module; codable; can be commoned with miniature adjacent jumpers; 1-pole	www.wago.com/769-502/000-016
	Item no.: 769-503 End module for 1-conductor female connector; 4 mm ² ; 1-pole	www.wago.com/769-503
	Item no.: 769-503/000-006 End module for 1-conductor female connector; 4 mm ² ; 1-pole	www.wago.com/769-503/000-006
	Item no.: 769-503/000-016 End module for 1-conductor female connector; 4 mm ² ; 1-pole	www.wago.com/769-503/000-016
	Item no.: 769-504 2-conductor base module; with integrated end plate; codable; can be commoned with adjacent jumpers and staggered jumpers; 1-pole	www.wago.com/769-504
	Item no.: 769-504/000-006 Start module for 2-conductor female connector; with integrated end plate; 4 mm ² ; 1-pole	www.wago.com/769-504/000-006
	Item no.: 769-504/000-016 Start module for 2-conductor female connector; 4 mm ² ; 1-pole	www.wago.com/769-504/000-016
	Item no.: 769-505 Center module for 2-conductor female connector; 4 mm ² ; 1-pole	www.wago.com/769-505
	Item no.: 769-505/000-006 Center module for 2-conductor female connector; 4 mm ² ; 1-pole	www.wago.com/769-505/000-006

	<p>Item no.: 769-505/000-016 Center module for 2-conductor female connector; 4 mm²; 1-pole</p>	www.wago.com/769-505/000-016
	<p>Item no.: 769-506 2-conductor end module; codable; can be commoned with adjacent jumpers and staggered jumpers; 1-pole</p>	www.wago.com/769-506
	<p>Item no.: 769-506/000-006 End module for 2-conductor female connector; 4 mm²; 1-pole</p>	www.wago.com/769-506/000-006
	<p>Item no.: 769-506/000-016 End module for 2-conductor female connector; 4 mm²; 1-pole</p>	www.wago.com/769-506/000-016
	<p>Item no.: 769-512 Start module for 1-conductor female connector; angled; 4 mm²; 1-pole</p>	www.wago.com/769-512
	<p>Item no.: 769-512/000-006 Start module for 1-conductor female connector; angled; 4 mm²; 1-pole</p>	www.wago.com/769-512/000-006
	<p>Item no.: 769-512/000-016 Start module for 1-conductor female connector; angled; 4 mm²; 1-pole</p>	www.wago.com/769-512/000-016
	<p>Item no.: 769-513 Center module for 1-conductor female connector; angled; 4 mm²; 1-pole</p>	www.wago.com/769-513
	<p>Item no.: 769-513/000-006 1-conductor center module; angled; codable; 1-pole</p>	www.wago.com/769-513/000-006
	<p>Item no.: 769-513/000-016 1-conductor center module; angled; codable; 1-pole</p>	www.wago.com/769-513/000-016
	<p>Item no.: 769-515 1-conductor end module; angled; codable; 1-pole</p>	www.wago.com/769-515
	<p>Item no.: 769-515/000-006 1-conductor end module; angled; codable; 1-pole</p>	www.wago.com/769-515/000-006
	<p>Item no.: 769-515/000-016 1-conductor end module; angled; codable; 1-pole</p>	www.wago.com/769-515/000-016
tools		
	<p>Item no.: 210-720 Operating tool with partially insulated shaft; Type 2, blade (3.5 x 0.5) mm</p>	www.wago.com/210-720
End plate		
	<p>Item no.: 769-309 End and intermediate plate; 1.1 mm thick</p>	www.wago.com/769-309



Item no.: 769-310
End and intermediate plate; 1.1 mm thick

www.wago.com/769-310



Item no.: 769-313
Separator plate; 1.1 mm thick; oversized

www.wago.com/769-313

Jumper



Item no.: 249-123
Push-in type wire jumper; insulated; wire length 180 mm; Conductor cross section 0.75 mm²

www.wago.com/249-123



Item no.: 249-125
Push-in type wire jumper; insulated; wire length 60 mm; Conductor cross section 0.75 mm²

www.wago.com/249-125



Item no.: 249-126
Push-in type wire jumper; insulated; wire length 110 mm; Conductor cross section 0.75 mm²

www.wago.com/249-126



Item no.: 249-127
Push-in type wire jumper; insulated; wire length 250 mm; Conductor cross section 0.75 mm²

www.wago.com/249-127



Item no.: 280-402
Adjacent jumper; insulated; IN = IN terminal block

www.wago.com/280-402



Item no.: 280-409
Alternate jumper; insulated; IN = IN terminal block

www.wago.com/280-409



Item no.: 780-452
Staggered jumper; insulated; from 1 to 2; Spacing: 5 mm; suitable for 2-conductor female plugs

www.wago.com/780-452



Item no.: 780-453
Staggered jumper; insulated; from 1 to 3; Spacing: 5 mm; suitable for 2-conductor female plugs

www.wago.com/780-453



Item no.: 780-454
Staggered jumper; insulated; from 1 to 4; Spacing: 5 mm; suitable for 2-conductor female plugs

www.wago.com/780-454



Item no.: 780-455
Staggered jumper; insulated; from 1 to 5; Spacing: 5 mm; suitable for 2-conductor female plugs

www.wago.com/780-455



Item no.: 780-456
Staggered jumper; insulated; from 1 to 6; Spacing: 5 mm; suitable for 2-conductor female plugs

www.wago.com/780-456



Item no.: 780-457
Staggered jumper; insulated; from 1 to 7; Spacing: 5 mm; suitable for 2-conductor female plugs

www.wago.com/780-457



Item no.: 780-458
Staggered jumper; insulated; from 1 to 8; Spacing: 5 mm; suitable for 2-conductor female plugs

www.wago.com/780-458

Coding



Item no.: 769-435
Coding pin; for coding of female plugs; for carrier terminal blocks / male connectors

www.wago.com/769-435

Downloads Documentation

Bid Text



769-202

Oct 18, 2017

DOC
25.1 kB

Download

smartDATA

CAD data

3D Download 769-202

URL

Download

Product family

X-COM

[Learn more about the product family.](#)

[Show all products from the family](#)

Subject to changes.

WAGO Kontakttechnik GmbH & Co. KG

Hansastr. 27

32423 Minden

Phone: +49571 887-0 | Fax: +49571 887-169

Email: info.de@wago.com | Web: www.wago.com

Do you have any questions about our products?

We are always happy to take your call at +49 (571) 887-44222.