

Data sheet | Item number: 769-211

2-conductor/2-pin carrier terminal block; with shield contact; for DIN-rail 35 x 15 and 35 x 7.5; 4 mm²; CAGE CLAMP®

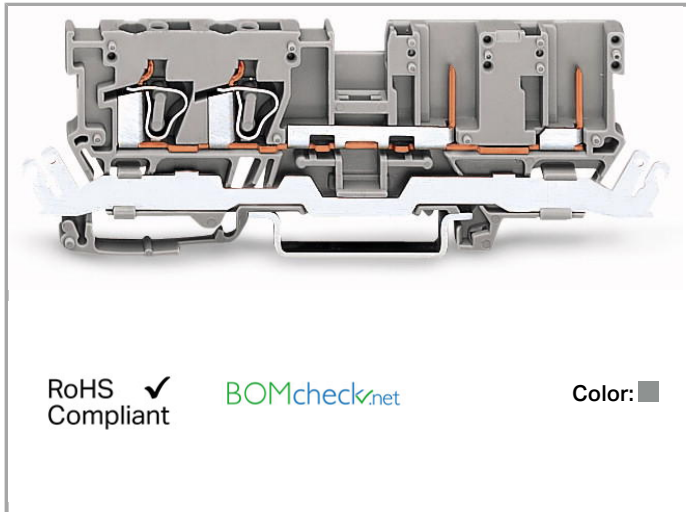

www.wago.com/769-211



RoHS
Compliant ✓

BOMcheck.net

Color: ■

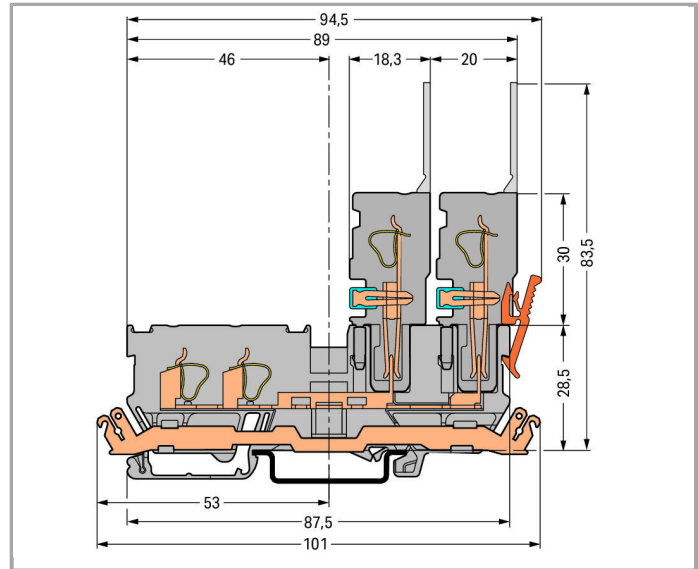

Data

Electrical data

Ratings per IEC/EN 60664-1

Rated voltage (III / 3)	250 V
Rated impulse voltage (III / 3)	4 kV
Rated current	32 A
Legend (ratings)	(III / 3) ≙ Overvoltage category III / Pollution degree 3

Connection data

Connection technology	CAGE CLAMP®
Actuation type	Operating tool
Connectable conductor materials	Copper Aluminum
Nominal cross section	4 mm ²
Solid conductor	0.08 ... 4 mm ² / 28 ... 12 AWG
Fine-stranded conductor	0.08 ... 4 mm ² / 28 ... 12 AWG
Strip length	8 ... 9 mm / 0.31 ... 0.35 Inch
Total number of connection points	2
Total number of potentials	1
Number of levels	1
Type of wiring	Front-entry wiring

Geometrical Data

Width	5 mm / 0.197 inch
Height from upper-edge of DIN-35 rail	28.5 mm / 1.122 inch
Depth	101 mm / 3.976 inch

Mechanical data

Design	horizontal
Type of mounting	DIN-35 rail
Marking level	Center marking

Material Data



Color	gray
Insulating material	Polyamide 66 (PA 66)
Fire load	0.173 MJ
Weight	13.1 g

Commercial data

Country of origin	DE
GTIN	4044918556071
Customs Tariff No.	85369010000
Product Group	18 (X-COM-System)

Approvals / Certificates

Country specific Approvals

Logo	Approval	Certificate name
	CCA DEKRA Certification B.V.	NTR NL-7626
	CSA DEKRA Certification B.V.	1101144
	KEMA/KEUR DEKRA Certification B.V.	2190419.01

Ship Approvals

Logo	Approval	Certificate name
	ABS	14-HG1293677-PDA

American Bureau of Shipping

ABS

BV



BV
 Bureau Veritas S.A.

07436/E0 BV

LR
 Lloyds Register









91/20112 (E9)





UL-Approvals

Logo	Approval	Certificate name
	UR Underwriters Laboratories Inc.	E45172
	UR Underwriters Laboratories Inc.	E45171

Compatible products

Jumper



	Item no.: 249-123 Push-in type wire jumper; insulated; wire length 180 mm; Conductor cross section 0.75 mm ²	www.wago.com/249-123
	Item no.: 249-125 Push-in type wire jumper; insulated; wire length 60 mm; Conductor cross section 0.75 mm ²	www.wago.com/249-125
	Item no.: 249-126 Push-in type wire jumper; insulated; wire length 110 mm; Conductor cross section 0.75 mm ²	www.wago.com/249-126
	Item no.: 249-127 Push-in type wire jumper; insulated; wire length 250 mm; Conductor cross section 0.75 mm ²	www.wago.com/249-127
	Item no.: 280-402 Adjacent jumper; insulated; IN = IN terminal block	www.wago.com/280-402
	Item no.: 280-409 Alternate jumper; insulated; IN = IN terminal block	www.wago.com/280-409
	Item no.: 780-452 Staggered jumper; insulated; from 1 to 2; Spacing: 5 mm; suitable for 2-conductor female plugs	www.wago.com/780-452
	Item no.: 780-453 Staggered jumper; insulated; from 1 to 3; Spacing: 5 mm; suitable for 2-conductor female plugs	www.wago.com/780-453

	Item no.: 780-454 Staggered jumper; insulated; from 1 to 4; Spacing: 5 mm; suitable for 2-conductor female plugs	www.wago.com/780-454
	Item no.: 780-455 Staggered jumper; insulated; from 1 to 5; Spacing: 5 mm; suitable for 2-conductor female plugs	www.wago.com/780-455
	Item no.: 780-456 Staggered jumper; insulated; from 1 to 6; Spacing: 5 mm; suitable for 2-conductor female plugs	www.wago.com/780-456
	Item no.: 780-457 Staggered jumper; insulated; from 1 to 7; Spacing: 5 mm; suitable for 2-conductor female plugs	www.wago.com/780-457
	Item no.: 780-458 Staggered jumper; insulated; from 1 to 8; Spacing: 5 mm; suitable for 2-conductor female plugs	www.wago.com/780-458







check

	Item no.: 210-136 Test plug; 2 mm Ø; with 500 mm cable	www.wago.com/210-136
	Item no.: 210-137 Test plug; 2.3 mm Ø; with 500 mm cable	www.wago.com/210-137

Insulation stop

	Item no.: 769-470 Insulation stop; 0.08 - 0.2 mm ² "s" (0.14 mm ² "f-st"); 5 pieces/strip	www.wago.com/769-470
	Item no.: 769-471 Insulation stop; 0.25 - 0.5 mm ² ; 5 pieces/strip	www.wago.com/769-471
	Item no.: 769-472 Insulation stop; 0.75 - 1 mm ² ; 5 pieces/strip	www.wago.com/769-472













ferrule









	Item no.: 216-101 Ferrule; Sleeve for 0.5 mm ² / AWG 22; uninsulated; electro-tin plated	www.wago.com/216-101
	Item no.: 216-102 Ferrule; Sleeve for 0.75 mm ² / AWG 20; uninsulated; electro-tin plated	www.wago.com/216-102
	Item no.: 216-103 Ferrule; Sleeve for 1 mm ² / AWG 18; uninsulated; electro-tin plated	www.wago.com/216-103
	Item no.: 216-104 Ferrule; Sleeve for 1.5 mm ² / AWG 16; uninsulated; electro-tin plated	www.wago.com/216-104
	Item no.: 216-201 Ferrule; Sleeve for 0.5 mm ² / AWG 22; insulated; electro-tin plated	www.wago.com/216-201
	Item no.: 216-202 Ferrule; Sleeve for 0.75 mm ² / AWG 20; insulated; electro-tin plated	www.wago.com/216-202
	Item no.: 216-203 Ferrule; Sleeve for 1 mm ² / AWG 18; insulated; electro-tin plated	www.wago.com/216-203
	Item no.: 216-204 Ferrule; Sleeve for 1.5 mm ² / AWG 16; insulated; electro-tin plated	www.wago.com/216-204





**Item no.: 216-206**Ferrule; Sleeve for 2.5 mm² / AWG 14; insulated; electro-tin platedwww.wago.com/216-206**Item no.: 216-301**Ferrule; Sleeve for 0.25 mm² / AWG 24; insulated; electro-tin platedwww.wago.com/216-301**Item no.: 216-302**Ferrule; Sleeve for 0.34 mm² / AWG 24; insulated; electro-tin platedwww.wago.com/216-302**Protective Warning Marker****Item no.: 280-415**





Protective warning marker; with high-voltage symbol, black; for 5 terminal blocks



www.wago.com/280-415**Female plug****Item no.: 769-101**1-conductor female plug; 4 mm²; 1-polewww.wago.com/769-101**Item no.: 769-101/000-006**1-conductor female plug; 4 mm²; 1-polewww.wago.com/769-101/000-006**Item no.: 769-101/000-016**1-conductor female plug; 4 mm²; 1-polewww.wago.com/769-101/000-016**Item no.: 769-102**1-conductor female plug; 4 mm²; 2-polewww.wago.com/769-102**Item no.: 769-102/000-006**1-conductor female plug; 4 mm²; 2-polewww.wago.com/769-102/000-006**Item no.: 769-102/000-036**1-conductor female plug; 4 mm²; 2-polewww.wago.com/769-102/000-036**Item no.: 769-102/000-037**1-conductor female plug; 4 mm²; 2-polewww.wago.com/769-102/000-037**Item no.: 769-103**1-conductor female plug; 4 mm²; 3-polewww.wago.com/769-103**Item no.: 769-103/000-006**1-conductor female plug; 4 mm²; 3-polewww.wago.com/769-103/000-006**Item no.: 769-103/000-036**1-conductor female plug; 4 mm²; 3-polewww.wago.com/769-103/000-036**Item no.: 769-103/000-037**1-conductor female plug; 4 mm²; 3-polewww.wago.com/769-103/000-037

	Item no.: 769-103/000-038 1-conductor female plug; 4 mm ² ; 3-pole	www.wago.com/769-103/000-038
	Item no.: 769-103/000-039 1-conductor female plug; 4 mm ² ; 3-pole	www.wago.com/769-103/000-039
	Item no.: 769-104 1-conductor female plug; 4 mm ² ; 4-pole	www.wago.com/769-104
	Item no.: 769-104/000-006 1-conductor female plug; 4 mm ² ; 4-pole	www.wago.com/769-104/000-006
	Item no.: 769-104/000-036 1-conductor female plug; 4 mm ² ; 4-pole	www.wago.com/769-104/000-036
	Item no.: 769-104/000-037 1-conductor female plug; 4 mm ² ; 4-pole	www.wago.com/769-104/000-037
	Item no.: 769-104/000-038 1-conductor female plug; 4 mm ² ; 4-pole	www.wago.com/769-104/000-038
	Item no.: 769-104/000-039 1-conductor female plug; 4 mm ² ; 4-pole	www.wago.com/769-104/000-039
	Item no.: 769-105 1-conductor female plug; 4 mm ² ; 5-pole	www.wago.com/769-105
	Item no.: 769-105/000-006 1-conductor female plug; 4 mm ² ; 5-pole	www.wago.com/769-105/000-006
	Item no.: 769-105/000-036 1-conductor female plug; 4 mm ² ; 5-pole	www.wago.com/769-105/000-036
	Item no.: 769-105/000-037 1-conductor female plug; 4 mm ² ; 5-pole	www.wago.com/769-105/000-037
	Item no.: 769-105/000-038 1-conductor female plug; 4 mm ² ; 5-pole	www.wago.com/769-105/000-038
	Item no.: 769-105/000-039 1-conductor female plug; 4 mm ² ; 5-pole	www.wago.com/769-105/000-039
	Item no.: 769-106 1-conductor female plug; 4 mm ² ; 6-pole	www.wago.com/769-106

	<p>Item no.: 769-106/000-006 1-conductor female plug; 4 mm²; 6-pole</p>	<p>www.wago.com/769-106/000-006</p>
	<p>Item no.: 769-106/000-036 1-conductor female plug; 4 mm²; 6-pole</p>	<p>www.wago.com/769-106/000-036</p>
	<p>Item no.: 769-106/000-037 1-conductor female plug; 4 mm²; 6-pole</p>	<p>www.wago.com/769-106/000-037</p>
	<p>Item no.: 769-106/000-038 1-conductor female plug; 4 mm²; 6-pole</p>	<p>www.wago.com/769-106/000-038</p>
	<p>Item no.: 769-106/000-039 1-conductor female plug; 4 mm²; 6-pole</p>	<p>www.wago.com/769-106/000-039</p>
	<p>Item no.: 769-107 1-conductor female plug; 4 mm²; 7-pole</p>	<p>www.wago.com/769-107</p>
	<p>Item no.: 769-107/000-006 1-conductor female plug; 4 mm²; 7-pole</p>	<p>www.wago.com/769-107/000-006</p>
	<p>Item no.: 769-107/000-036 1-conductor female plug; 4 mm²; 7-pole</p>	<p>www.wago.com/769-107/000-036</p>
	<p>Item no.: 769-107/000-037 1-conductor female plug; 4 mm²; 7-pole</p>	<p>www.wago.com/769-107/000-037</p>
	<p>Item no.: 769-107/000-038 1-conductor female plug; 4 mm²; 7-pole</p>	<p>www.wago.com/769-107/000-038</p>
	<p>Item no.: 769-107/000-039 1-conductor female plug; 4 mm²; 7-pole</p>	<p>www.wago.com/769-107/000-039</p>
	<p>Item no.: 769-108 1-conductor female plug; 4 mm²; 8-pole</p>	<p>www.wago.com/769-108</p>
	<p>Item no.: 769-108/000-006 1-conductor female plug; 4 mm²; 8-pole</p>	<p>www.wago.com/769-108/000-006</p>
	<p>Item no.: 769-108/000-036 1-conductor female plug; 4 mm²; 8-pole</p>	<p>www.wago.com/769-108/000-036</p>
	<p>Item no.: 769-108/000-037 1-conductor female plug; 4 mm²; 8-pole</p>	<p>www.wago.com/769-108/000-037</p>

	<p>Item no.: 769-108/000-038 1-conductor female plug; 4 mm²; 8-pole</p>	<p>www.wago.com/769-108/000-038</p>
	<p>Item no.: 769-108/000-039 1-conductor female plug; 4 mm²; 8-pole</p>	<p>www.wago.com/769-108/000-039</p>
	<p>Item no.: 769-109 1-conductor female plug; 4 mm²; 9-pole</p>	<p>www.wago.com/769-109</p>
	<p>Item no.: 769-109/000-006 1-conductor female plug; 4 mm²; 9-pole</p>	<p>www.wago.com/769-109/000-006</p>
	<p>Item no.: 769-109/000-036 1-conductor female plug; 4 mm²; 9-pole</p>	<p>www.wago.com/769-109/000-036</p>
	<p>Item no.: 769-109/000-037 1-conductor female plug; 4 mm²; 9-pole</p>	<p>www.wago.com/769-109/000-037</p>
	<p>Item no.: 769-109/000-038 1-conductor female plug; 4 mm²; 9-pole</p>	<p>www.wago.com/769-109/000-038</p>
	<p>Item no.: 769-109/000-039 1-conductor female plug; 4 mm²; 9-pole</p>	<p>www.wago.com/769-109/000-039</p>
	<p>Item no.: 769-110 1-conductor female plug; 4 mm²; 10-pole</p>	<p>www.wago.com/769-110</p>
	<p>Item no.: 769-110/000-006 1-conductor female plug; 4 mm²; 10-pole</p>	<p>www.wago.com/769-110/000-006</p>
	<p>Item no.: 769-110/000-036 1-conductor female plug; 4 mm²; 10-pole</p>	<p>www.wago.com/769-110/000-036</p>
	<p>Item no.: 769-110/000-037 1-conductor female plug; 4 mm²; 10-pole</p>	<p>www.wago.com/769-110/000-037</p>
	<p>Item no.: 769-110/000-038 1-conductor female plug; 4 mm²; 10-pole</p>	<p>www.wago.com/769-110/000-038</p>
	<p>Item no.: 769-110/000-039 1-conductor female plug; 4 mm²; 10-pole</p>	<p>www.wago.com/769-110/000-039</p>
	<p>Item no.: 769-111 1-conductor female plug; 4 mm²; 11-pole</p>	<p>www.wago.com/769-111</p>

	Item no.: 769-111/000-006 1-conductor female plug; 4 mm ² ; 11-pole	www.wago.com/769-111/000-006
	Item no.: 769-111/000-036 1-conductor female plug; 4 mm ² ; 11-pole	www.wago.com/769-111/000-036
	Item no.: 769-111/000-037 1-conductor female plug; 4 mm ² ; 11-pole	www.wago.com/769-111/000-037
	Item no.: 769-111/000-038 1-conductor female plug; 4 mm ² ; 11-pole	www.wago.com/769-111/000-038
	Item no.: 769-111/000-039 1-conductor female plug; 4 mm ² ; 11-pole	www.wago.com/769-111/000-039
	Item no.: 769-112 1-conductor female plug; 4 mm ² ; 12-pole	www.wago.com/769-112
	Item no.: 769-112/000-006 1-conductor female plug; 4 mm ² ; 12-pole	www.wago.com/769-112/000-006
	Item no.: 769-112/000-036 1-conductor female plug; 4 mm ² ; 12-pole	www.wago.com/769-112/000-036
	Item no.: 769-112/000-037 1-conductor female plug; 4 mm ² ; 12-pole	www.wago.com/769-112/000-037
	Item no.: 769-112/000-038 1-conductor female plug; 4 mm ² ; 12-pole	www.wago.com/769-112/000-038
	Item no.: 769-112/000-039 1-conductor female plug; 4 mm ² ; 12-pole	www.wago.com/769-112/000-039
	Item no.: 769-113 1-conductor female plug; 4 mm ² ; 13-pole	www.wago.com/769-113
	Item no.: 769-113/000-036 1-conductor female plug; 4 mm ² ; 13-pole	www.wago.com/769-113/000-036
	Item no.: 769-113/000-037 1-conductor female plug; 4 mm ² ; 13-pole	www.wago.com/769-113/000-037
	Item no.: 769-113/000-038 1-conductor female plug; 4 mm ² ; 13-pole	www.wago.com/769-113/000-038





	Item no.: 769-113/000-039 1-conductor female plug; 4 mm ² ; 13-pole	www.wago.com/769-113/000-039
	Item no.: 769-114 1-conductor female plug; 4 mm ² ; 14-pole	www.wago.com/769-114
	Item no.: 769-114/000-006 1-conductor female plug; 4 mm ² ; 14-pole	www.wago.com/769-114/000-006
	Item no.: 769-114/000-036 1-conductor female plug; 4 mm ² ; 14-pole	www.wago.com/769-114/000-036
	Item no.: 769-114/000-037 1-conductor female plug; 4 mm ² ; 14-pole	www.wago.com/769-114/000-037
	Item no.: 769-114/000-038 1-conductor female plug; 4 mm ² ; 14-pole	www.wago.com/769-114/000-038
	Item no.: 769-114/000-039 1-conductor female plug; 4 mm ² ; 14-pole	www.wago.com/769-114/000-039
	Item no.: 769-115 1-conductor female plug; 4 mm ² ; 15-pole	www.wago.com/769-115
	Item no.: 769-115/000-036 1-conductor female plug; 4 mm ² ; 15-pole	www.wago.com/769-115/000-036
	Item no.: 769-115/000-037 1-conductor female plug; 4 mm ² ; 15-pole	www.wago.com/769-115/000-037
	Item no.: 769-115/000-038 1-conductor female plug; 4 mm ² ; 15-pole	www.wago.com/769-115/000-038
	Item no.: 769-115/000-039 1-conductor female plug; 4 mm ² ; 15-pole	www.wago.com/769-115/000-039
	Item no.: 769-121 2-conductor female connector; 4 mm ² ; 1-pole	www.wago.com/769-121
	Item no.: 769-121/000-016 2-conductor female connector; 4 mm ² ; 1-pole	www.wago.com/769-121/000-016
	Item no.: 769-122 2-conductor female connector; 4 mm ² ; 2-pole	www.wago.com/769-122
	Item no.: 769-123 2-conductor female connector; 4 mm ² ; 3-pole	www.wago.com/769-123

	Item no.: 769-124 2-conductor female connector; 4 mm ² ; 4-pole	www.wago.com/769-124
	Item no.: 769-125 2-conductor female connector; 4 mm ² ; 5-pole	www.wago.com/769-125
	Item no.: 769-126 2-conductor female connector; 4 mm ² ; 6-pole	www.wago.com/769-126
	Item no.: 769-127 2-conductor female connector; 4 mm ² ; 7-pole	www.wago.com/769-127
	Item no.: 769-128 2-conductor female connector; 4 mm ² ; 8-pole	www.wago.com/769-128
	Item no.: 769-129 2-conductor female connector; 4 mm ² ; 9-pole	www.wago.com/769-129
	Item no.: 769-130 2-conductor female connector; 4 mm ² ; 10-pole	www.wago.com/769-130
	Item no.: 769-131 2-conductor female connector; 4 mm ² ; 11-pole	www.wago.com/769-131
	Item no.: 769-132 2-conductor female connector; 4 mm ² ; 12-pole	www.wago.com/769-132
	Item no.: 769-133 2-conductor female connector; 4 mm ² ; 13-pole	www.wago.com/769-133
	Item no.: 769-134 2-conductor female connector; 4 mm ² ; 14-pole	www.wago.com/769-134
	Item no.: 769-135 2-conductor female connector; 4 mm ² ; 15-pole	www.wago.com/769-135

















tools

	Item no.: 210-720 Operating tool with partially insulated shaft; Type 2, blade (3.5 x 0.5) mm	www.wago.com/210-720
--	---	--

General accessories

	Item no.: 280-404 Test plug adapter; 5 mm wide; for test plug 210-137 (2.3 mm Ø); suitable for 1.5 mm ² - 4 mm ² tbs	www.wago.com/280-404
	Item no.: 280-418 Test plug module; modular; suitable for all WAGO 280 and 780 Series rail-mounted terminal blocks with jumper slots in the current bar	www.wago.com/280-418
	Item no.: 280-419 Spacer module; modular; bridging commoned terminal blocks	www.wago.com/280-419
	Item no.: 769-438 Pin cover; with marker slot for miniature WSB	www.wago.com/769-438
	Item no.: 769-439 Pin cover; with marker slot for miniature WSB	www.wago.com/769-439

Item no.: 769-501

	Start module for 1-conductor female connector; with integrated end plate; 4 mm ² ; 1-pole	www.wago.com/769-501
	Item no.: 769-501/000-006 Start module for 1-conductor female connector; 4 mm ² ; 1-pole	www.wago.com/769-501/000-006
	Item no.: 769-501/000-016 Start module for 1-conductor female connector; with integrated end plate; 4 mm ² ; 1-pole	www.wago.com/769-501/000-016
	Item no.: 769-502 Center module for 1-conductor female connector; 4 mm ² ; 1-pole	www.wago.com/769-502
	Item no.: 769-502/000-006 Center module for 1-conductor female connector; 4 mm ² ; 1-pole	www.wago.com/769-502/000-006
	Item no.: 769-502/000-016 1-conductor center module; codable; can be commoned with miniature adjacent jumpers; 1-pole	www.wago.com/769-502/000-016
	Item no.: 769-503 End module for 1-conductor female connector; 4 mm ² ; 1-pole	www.wago.com/769-503
	Item no.: 769-503/000-006 End module for 1-conductor female connector; 4 mm ² ; 1-pole	www.wago.com/769-503/000-006
	Item no.: 769-503/000-016 End module for 1-conductor female connector; 4 mm ² ; 1-pole	www.wago.com/769-503/000-016
	Item no.: 769-504 2-conductor base module; with integrated end plate; codable; can be commoned with adjacent jumpers and staggered jumpers; 1-pole	www.wago.com/769-504
	Item no.: 769-504/000-006 Start module for 2-conductor female connector; with integrated end plate; 4 mm ² ; 1-pole	www.wago.com/769-504/000-006
	Item no.: 769-504/000-016 Start module for 2-conductor female connector; 4 mm ² ; 1-pole	www.wago.com/769-504/000-016
	Item no.: 769-505 Center module for 2-conductor female connector; 4 mm ² ; 1-pole	www.wago.com/769-505
	Item no.: 769-505/000-006 Center module for 2-conductor female connector; 4 mm ² ; 1-pole	www.wago.com/769-505/000-006
	Item no.: 769-505/000-016 Center module for 2-conductor female connector; 4 mm ² ; 1-pole	www.wago.com/769-505/000-016
	Item no.: 769-506 2-conductor end module; codable; can be commoned with adjacent jumpers and staggered jumpers; 1-pole	www.wago.com/769-506



Item no.: 769-506/000-006
End module for 2-conductor female connector; 4 mm²; 1-pole

www.wago.com/769-506/000-006



Item no.: 769-506/000-016
End module for 2-conductor female connector; 4 mm²; 1-pole

www.wago.com/769-506/000-016



Item no.: 769-512
Start module for 1-conductor female connector; angled; 4 mm²; 1-pole

www.wago.com/769-512



Item no.: 769-512/000-006
Start module for 1-conductor female connector; angled; 4 mm²; 1-pole

www.wago.com/769-512/000-006



Item no.: 769-512/000-016
Start module for 1-conductor female connector; angled; 4 mm²; 1-pole

www.wago.com/769-512/000-016



Item no.: 769-513
Center module for 1-conductor female connector; angled; 4 mm²; 1-pole

www.wago.com/769-513



Item no.: 769-513/000-006
1-conductor center module; angled; codable; 1-pole

www.wago.com/769-513/000-006



Item no.: 769-513/000-016
1-conductor center module; angled; codable; 1-pole

www.wago.com/769-513/000-016



Item no.: 769-515
1-conductor end module; angled; codable; 1-pole

www.wago.com/769-515



Item no.: 769-515/000-006
1-conductor end module; angled; codable; 1-pole

www.wago.com/769-515/000-006



Item no.: 769-515/000-016
1-conductor end module; angled; codable; 1-pole

www.wago.com/769-515/000-016

assembling



Item no.: 209-106
Mounting carrier; for isolated mounting on DIN 35 rails

www.wago.com/209-106

End plate



Item no.: 769-303
End and intermediate plate; 1.1 mm thick

www.wago.com/769-303



Item no.: 769-304
End and intermediate plate; 1.1 mm thick

www.wago.com/769-304



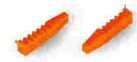











Coding



Item no.: 769-435
Coding pin; for coding of female plugs; for carrier terminal blocks / male connectors

www.wago.com/769-435

Marking accessories

	Item no.: 2009-145 Mini-WSB Inline; for smartPRINTER; on reel; stretchable 5 - 5.2 mm; plain; snap-on type	www.wago.com/2009-145
	Item no.: 2009-145/000-002 Mini-WSB Inline; for smartPRINTER; on reel; stretchable 5 - 5.2 mm; plain; snap-on type	www.wago.com/2009-145/000-002
	Item no.: 2009-145/000-005 Mini-WSB Inline; for smartPRINTER; on reel; stretchable 5 - 5.2 mm; plain; snap-on type	www.wago.com/2009-145/000-005
	Item no.: 2009-145/000-006 Mini-WSB Inline; for smartPRINTER; on reel; stretchable 5 - 5.2 mm; plain; snap-on type	www.wago.com/2009-145/000-006
	Item no.: 2009-145/000-007 Mini-WSB Inline; for smartPRINTER; on reel; stretchable 5 - 5.2 mm; plain; snap-on type	www.wago.com/2009-145/000-007
	Item no.: 2009-145/000-012 Mini-WSB Inline; for smartPRINTER; on reel; stretchable 5 - 5.2 mm; plain; snap-on type	www.wago.com/2009-145/000-012
	Item no.: 2009-145/000-023 Mini-WSB Inline; for smartPRINTER; on reel; stretchable 5 - 5.2 mm; plain; snap-on type	www.wago.com/2009-145/000-023
	Item no.: 2009-145/000-024 Mini-WSB Inline; on reel; stretchable 5 - 5.2 mm; plain; snap-on type	www.wago.com/2009-145/000-024
	Item no.: 248-501 Miniature WSB Quick marking system; plain; Marker width 5 mm; 10 strips with 10 markers per card	www.wago.com/248-501
	Item no.: 248-501/000-002 Mini-WSB marking card; as card; not stretchable; plain; snap-on type	www.wago.com/248-501/000-002
	Item no.: 248-501/000-005 Mini-WSB marking card; as card; plain; snap-on type	www.wago.com/248-501/000-005
	Item no.: 248-501/000-006 Mini-WSB marking card; as card; not stretchable; plain; snap-on type	www.wago.com/248-501/000-006
	Item no.: 248-501/000-007 Mini-WSB marking card; as card; not stretchable; plain; snap-on type	www.wago.com/248-501/000-007
	Item no.: 248-501/000-012 Mini-WSB marking card; as card; not stretchable; plain; snap-on type	www.wago.com/248-501/000-012

**Item no.: 248-501/000-017**

Mini-WSB marking card; as card; not stretchable; plain; snap-on type

www.wago.com/248-501/000-017**Item no.: 248-501/000-023**

Mini-WSB marking card; as card; not stretchable; plain; snap-on type

www.wago.com/248-501/000-023**Item no.: 248-501/000-024**

Mini-WSB marking card; as card; not stretchable; plain; snap-on type

www.wago.com/248-501/000-024**Carrier rail****Item no.: 210-112**

Steel carrier rail; 35 x 7.5 mm; 1 mm thick; 2 m long; slotted; according to EN 60715; "Hole width 25 mm

www.wago.com/210-112**Item no.: 210-113**

Steel carrier rail; 35 x 7.5 mm; 1 mm thick; 2 m long; unslotted; according to EN 60715

www.wago.com/210-113**Item no.: 210-114**

Steel carrier rail; 35 x 15 mm; 1.5 mm thick; 2 m long; unslotted; similar to EN 60715

www.wago.com/210-114**Item no.: 210-115**

Steel carrier rail; 35 x 7.5 mm; 1 mm thick; 2 m long; slotted; according to EN 60715; "Hole width 18 mm

www.wago.com/210-115**Item no.: 210-118**

Steel carrier rail; 35 x 15 mm; 2.3 mm thick; 2 m long; unslotted; according to EN 60715

www.wago.com/210-118**Item no.: 210-196**

Aluminum carrier rail; 35 x 8.2 mm; 1.6 mm thick; 2 m long; unslotted; similar to EN 60715

www.wago.com/210-196**Item no.: 210-197**

Steel carrier rail; 35 x 15 mm; 1.5 mm thick; 2 m long; slotted; similar to EN 60715

www.wago.com/210-197**Item no.: 210-198**

Copper carrier rail; 35 x 15 mm; 2.3 mm thick; 2 m long; unslotted; according to EN 60715

www.wago.com/210-198**Item no.: 210-504**

Steel carrier rail; 35 x 7.5 mm; 1 mm thick; 2 m long; slotted; galvanized; according to EN 60715

www.wago.com/210-504**Item no.: 210-505**

Steel carrier rail; 35 x 7.5 mm; 1 mm thick; 2 m long; unslotted; galvanized; according to EN 60715

www.wago.com/210-505**Item no.: 210-506**

Steel carrier rail; 35 x 15 mm; 1.5 mm thick; 2 m long; unslotted; galvanized; similar to EN 60715

www.wago.com/210-506**Item no.: 210-508**

Steel carrier rail; 35 x 15 mm; 1.5 mm thick; 2 m long; slotted; galvanized; similar to EN 60715

www.wago.com/210-508**Downloads****Documentation****Bid Text**



769-211

Oct 18, 2017

DOC
25.1 kB

Download

smartDATA

CAD data

3D Download 769-211

URL

Download

Product family

X-COM

[Learn more about the product family.](#)

[Show all products from the family](#)

Subject to changes.

WAGO Kontakttechnik GmbH & Co. KG

Hansastr. 27

32423 Minden

Phone: +49571 887-0 | Fax: +49571 887-169

Email: info.de@wago.com | Web: www.wago.com

Do you have any questions about our products?

We are always happy to take your call at +49 (571) 887-44222.