

Data sheet | Item number: 769-610/002-000

1-conductor male connector; clamping collar; 4 mm²; Pin spacing 5 mm; 10-pole

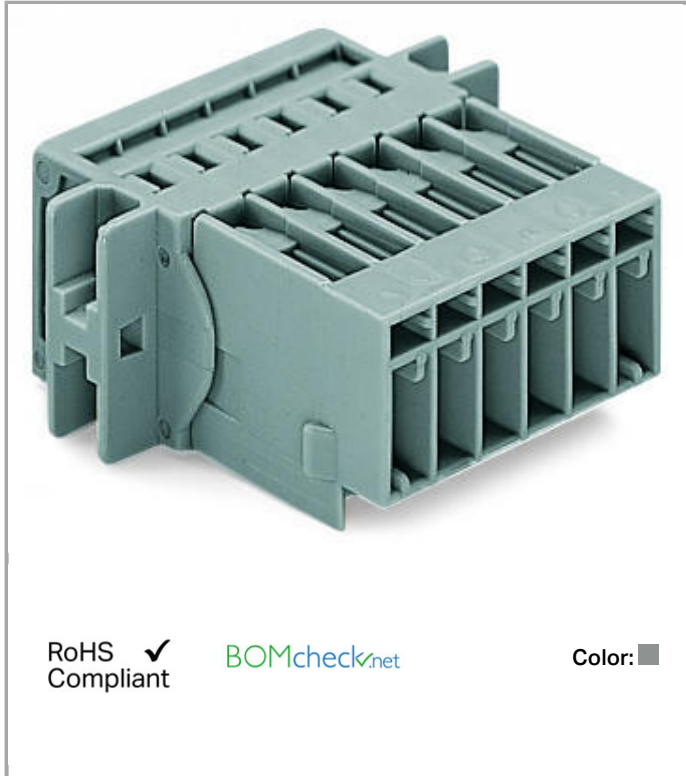

www.wago.com/769-610/002-000



RoHS Compliant

BOMcheck.net

Color: ■

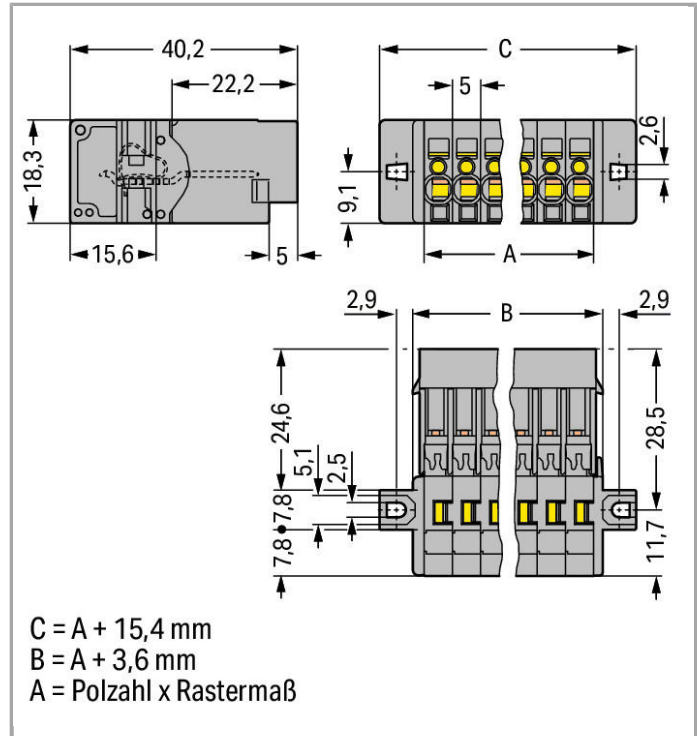

Data

Electrical data

Ratings per IEC/EN 60664-1

Rated voltage (III / 3)	500 V
Rated impulse voltage (III / 3)	6 kV
Rated current	32 A
Legend (ratings)	(III / 3) ≙ Overvoltage category III / Pollution degree 3

Connection data

Connection technology	CAGE CLAMP®
Actuation type	Operating tool
Connectable conductor materials	Copper Aluminum
Nominal cross section	4 mm ²
Solid conductor	0.08 ... 4 mm ² / 28 ... 12 AWG
Fine-stranded conductor	0.08 ... 4 mm ² / 28 ... 12 AWG



Strip length	8 ... 9 mm / 0.31 ... 0.35 Inch
No. of poles	10
Total number of connection points	10
Total number of potentials	10
Type of wiring	Front-entry wiring

Geometrical Data

Pin spacing	5 mm / 0.197 inch
Width	65.4 mm / 2.575 inch
Height from the surface	18.3 mm / 0.72 inch
Depth	40.2 mm / 1.583 inch

Mechanical data

Mounting type	Mounting flange
---------------	-----------------

Plug connection

Contact type (pluggable connector)	Male connector/plug
Connector connection type	for conductors

Material Data

Color	gray
Insulating material	Polyamide 66 (PA 66)
Fire load	0.618 MJ
Weight	30.424 g

Commercial data

Country of origin	PL
GTIN	4044918521550
Customs Tariff No.	85366990990
Product Group	18 (X-COM-System)

Approvals / Certificates

Country specific Approvals

Logo	Approval	Certificate name
	CCA DEKRA Certification B.V.	NTR NL-7626
	CSA DEKRA Certification B.V.	1101144





KEMA/KEUR

2190419.01





DEKRA Certification B.V.

UL-Approvals





Logo	Approval	Certificate name
	UR Underwriters Laboratories Inc.	E45171
	UR Underwriters Laboratories Inc.	E45172

















Compatible products

Insulation stop

	Item no.: 769-470 Insulation stop; 0.08 - 0.2 mm ² "s" (0.14 mm ² "f-st"); 5 pieces/strip	www.wago.com/769-470
	Item no.: 769-471 Insulation stop; 0.25 - 0.5 mm ² ; 5 pieces/strip	www.wago.com/769-471
	Item no.: 769-472 Insulation stop; 0.75 - 1 mm ² ; 5 pieces/strip	www.wago.com/769-472

Marking accessories

	Item no.: 2009-145 Mini-WSB Inline; for smartPRINTER; on reel; stretchable 5 - 5.2 mm; plain; snap-on type	www.wago.com/2009-145
	Item no.: 2009-145/000-002 Mini-WSB Inline; for smartPRINTER; on reel; stretchable 5 - 5.2 mm; plain; snap-on type	www.wago.com/2009-145/000-002
	Item no.: 2009-145/000-005 Mini-WSB Inline; for smartPRINTER; on reel; stretchable 5 - 5.2 mm; plain; snap-on type	www.wago.com/2009-145/000-005
	Item no.: 2009-145/000-006 Mini-WSB Inline; for smartPRINTER; on reel; stretchable 5 - 5.2 mm; plain; snap-on type	www.wago.com/2009-145/000-006
	Item no.: 2009-145/000-007 Mini-WSB Inline; for smartPRINTER; on reel; stretchable 5 - 5.2 mm; plain; snap-on type	www.wago.com/2009-145/000-007

	<p>Item no.: 2009-145/000-012 Mini-WSB Inline; for smartPRINTER; on reel; stretchable 5 - 5.2 mm; plain; snap-on type</p>	www.wago.com/2009-145/000-012
	<p>Item no.: 2009-145/000-023 Mini-WSB Inline; for smartPRINTER; on reel; stretchable 5 - 5.2 mm; plain; snap-on type</p>	www.wago.com/2009-145/000-023
	<p>Item no.: 2009-145/000-024 Mini-WSB Inline; on reel; stretchable 5 - 5.2 mm; plain; snap-on type</p>	www.wago.com/2009-145/000-024
	<p>Item no.: 210-831 Marking strips; on reel; 2.3 mm wide; plain; Self-adhesive</p>	www.wago.com/210-831
	<p>Item no.: 210-832 Marking strips; on reel; 3 mm wide; plain; Self-adhesive</p>	www.wago.com/210-832
	<p>Item no.: 210-833 Marking strips; on reel; 6 mm wide; plain; Self-adhesive</p>	www.wago.com/210-833
	<p>Item no.: 210-834 Marking strips; on reel; 5 mm wide; plain; Self-adhesive</p>	www.wago.com/210-834
	<p>Item no.: 248-501 Miniature WSB Quick marking system; plain; Marker width 5 mm; 10 strips with 10 markers per card</p>	www.wago.com/248-501
	<p>Item no.: 248-501/000-002 Mini-WSB marking card; as card; not stretchable; plain; snap-on type</p>	www.wago.com/248-501/000-002
	<p>Item no.: 248-501/000-005 Mini-WSB marking card; as card; plain; snap-on type</p>	www.wago.com/248-501/000-005
	<p>Item no.: 248-501/000-006 Mini-WSB marking card; as card; not stretchable; plain; snap-on type</p>	www.wago.com/248-501/000-006
	<p>Item no.: 248-501/000-007 Mini-WSB marking card; as card; not stretchable; plain; snap-on type</p>	www.wago.com/248-501/000-007
	<p>Item no.: 248-501/000-012 Mini-WSB marking card; as card; not stretchable; plain; snap-on type</p>	www.wago.com/248-501/000-012
	<p>Item no.: 248-501/000-017 Mini-WSB marking card; as card; not stretchable; plain; snap-on type</p>	www.wago.com/248-501/000-017
	<p>Item no.: 248-501/000-023 Mini-WSB marking card; as card; not stretchable; plain; snap-on type</p>	www.wago.com/248-501/000-023
	<p>Item no.: 248-501/000-024 Mini-WSB marking card; as card; not stretchable; plain; snap-on type</p>	www.wago.com/248-501/000-024

Strain relief plate



Item no.: 769-410
Strain relief plate

www.wago.com/769-410



Item no.: 769-414
Strain relief plate

www.wago.com/769-414

Coding



Item no.: 769-435
Coding pin; for coding of female plugs; for carrier terminal blocks / male connectors

www.wago.com/769-435

ferrule



Item no.: 216-101
Ferrule; Sleeve for 0.5 mm² / AWG 22; uninsulated; electro-tin plated

www.wago.com/216-101



Item no.: 216-102
Ferrule; Sleeve for 0.75 mm² / AWG 20; uninsulated; electro-tin plated

www.wago.com/216-102



Item no.: 216-103
Ferrule; Sleeve for 1 mm² / AWG 18; uninsulated; electro-tin plated

www.wago.com/216-103



Item no.: 216-104
Ferrule; Sleeve for 1.5 mm² / AWG 16; uninsulated; electro-tin plated

www.wago.com/216-104



Item no.: 216-201
Ferrule; Sleeve for 0.5 mm² / AWG 22; insulated; electro-tin plated

www.wago.com/216-201



Item no.: 216-202
Ferrule; Sleeve for 0.75 mm² / AWG 20; insulated; electro-tin plated

www.wago.com/216-202



Item no.: 216-203
Ferrule; Sleeve for 1 mm² / AWG 18; insulated; electro-tin plated

www.wago.com/216-203



Item no.: 216-204
Ferrule; Sleeve for 1.5 mm² / AWG 16; insulated; electro-tin plated

www.wago.com/216-204



Item no.: 216-206
Ferrule; Sleeve for 2.5 mm² / AWG 14; insulated; electro-tin plated

www.wago.com/216-206

Female plug



Item no.: 769-101
1-conductor female plug; 4 mm²; 1-pole

www.wago.com/769-101



Item no.: 769-101/000-016
1-conductor female plug; 4 mm²; 1-pole

www.wago.com/769-101/000-016















Item no.: 769-102
1-conductor female plug; 4 mm²; 2-pole

www.wago.com/769-102

Item no.: 769-102/000-036
1-conductor female plug; 4 mm²; 2-pole

www.wago.com/769-102/000-036

	<p>Item no.: 769-102/000-037 1-conductor female plug; 4 mm²; 2-pole</p>	<p>www.wago.com/769-102/000-037</p>
	<p>Item no.: 769-103 1-conductor female plug; 4 mm²; 3-pole</p>	<p>www.wago.com/769-103</p>
	<p>Item no.: 769-103/000-036 1-conductor female plug; 4 mm²; 3-pole</p>	<p>www.wago.com/769-103/000-036</p>
	<p>Item no.: 769-103/000-037 1-conductor female plug; 4 mm²; 3-pole</p>	<p>www.wago.com/769-103/000-037</p>
	<p>Item no.: 769-103/000-038 1-conductor female plug; 4 mm²; 3-pole</p>	<p>www.wago.com/769-103/000-038</p>
	<p>Item no.: 769-103/000-039 1-conductor female plug; 4 mm²; 3-pole</p>	<p>www.wago.com/769-103/000-039</p>
	<p>Item no.: 769-104 1-conductor female plug; 4 mm²; 4-pole</p>	<p>www.wago.com/769-104</p>
	<p>Item no.: 769-104/000-036 1-conductor female plug; 4 mm²; 4-pole</p>	<p>www.wago.com/769-104/000-036</p>
	<p>Item no.: 769-104/000-037 1-conductor female plug; 4 mm²; 4-pole</p>	<p>www.wago.com/769-104/000-037</p>
	<p>Item no.: 769-104/000-038 1-conductor female plug; 4 mm²; 4-pole</p>	<p>www.wago.com/769-104/000-038</p>
	<p>Item no.: 769-104/000-039 1-conductor female plug; 4 mm²; 4-pole</p>	<p>www.wago.com/769-104/000-039</p>
	<p>Item no.: 769-105 1-conductor female plug; 4 mm²; 5-pole</p>	<p>www.wago.com/769-105</p>
	<p>Item no.: 769-105/000-036 1-conductor female plug; 4 mm²; 5-pole</p>	<p>www.wago.com/769-105/000-036</p>
	<p>Item no.: 769-105/000-037 1-conductor female plug; 4 mm²; 5-pole</p>	<p>www.wago.com/769-105/000-037</p>
	<p>Item no.: 769-105/000-038 1-conductor female plug; 4 mm²; 5-pole</p>	<p>www.wago.com/769-105/000-038</p>



Item no.: 769-105/000-039
1-conductor female plug; 4 mm²; 5-pole

www.wago.com/769-105/000-039

Item no.: 769-106
1-conductor female plug; 4 mm²; 6-pole

www.wago.com/769-106

Item no.: 769-106/000-006
1-conductor female plug; 4 mm²; 6-pole

www.wago.com/769-106/000-006



Item no.: 769-106/000-036
1-conductor female plug; 4 mm²; 6-pole

www.wago.com/769-106/000-036



Item no.: 769-106/000-037
1-conductor female plug; 4 mm²; 6-pole

www.wago.com/769-106/000-037



Item no.: 769-106/000-038
1-conductor female plug; 4 mm²; 6-pole

www.wago.com/769-106/000-038



Item no.: 769-106/000-039
1-conductor female plug; 4 mm²; 6-pole

www.wago.com/769-106/000-039

Item no.: 769-107
1-conductor female plug; 4 mm²; 7-pole

www.wago.com/769-107



Item no.: 769-107/000-036
1-conductor female plug; 4 mm²; 7-pole

www.wago.com/769-107/000-036



Item no.: 769-107/000-037
1-conductor female plug; 4 mm²; 7-pole

www.wago.com/769-107/000-037



Item no.: 769-107/000-038
1-conductor female plug; 4 mm²; 7-pole

www.wago.com/769-107/000-038



Item no.: 769-107/000-039
1-conductor female plug; 4 mm²; 7-pole

www.wago.com/769-107/000-039

Item no.: 769-108
1-conductor female plug; 4 mm²; 8-pole







www.wago.com/769-108

Item no.: 769-108/000-036
1-conductor female plug; 4 mm²; 8-pole

www.wago.com/769-108/000-036

Item no.: 769-108/000-037
1-conductor female plug; 4 mm²; 8-pole

www.wago.com/769-108/000-037

	<p>Item no.: 769-108/000-038 1-conductor female plug; 4 mm²; 8-pole</p>	<p>www.wago.com/769-108/000-038</p>
	<p>Item no.: 769-108/000-039 1-conductor female plug; 4 mm²; 8-pole</p>	<p>www.wago.com/769-108/000-039</p>
	<p>Item no.: 769-109 1-conductor female plug; 4 mm²; 9-pole</p>	<p>www.wago.com/769-109</p>
	<p>Item no.: 769-109/000-036 1-conductor female plug; 4 mm²; 9-pole</p>	<p>www.wago.com/769-109/000-036</p>
	<p>Item no.: 769-109/000-037 1-conductor female plug; 4 mm²; 9-pole</p>	<p>www.wago.com/769-109/000-037</p>
	<p>Item no.: 769-109/000-038 1-conductor female plug; 4 mm²; 9-pole</p>	<p>www.wago.com/769-109/000-038</p>
	<p>Item no.: 769-109/000-039 1-conductor female plug; 4 mm²; 9-pole</p>	<p>www.wago.com/769-109/000-039</p>
	<p>Item no.: 769-110 1-conductor female plug; 4 mm²; 10-pole</p>	<p>www.wago.com/769-110</p>
	<p>Item no.: 769-110/000-036 1-conductor female plug; 4 mm²; 10-pole</p>	<p>www.wago.com/769-110/000-036</p>
	<p>Item no.: 769-110/000-037 1-conductor female plug; 4 mm²; 10-pole</p>	<p>www.wago.com/769-110/000-037</p>
	<p>Item no.: 769-110/000-038 1-conductor female plug; 4 mm²; 10-pole</p>	<p>www.wago.com/769-110/000-038</p>
	<p>Item no.: 769-110/000-039 1-conductor female plug; 4 mm²; 10-pole</p>	<p>www.wago.com/769-110/000-039</p>
	<p>Item no.: 769-110/021-000 1-conductor female plug; Locking lever; 4 mm²; 10-pole</p>	<p>www.wago.com/769-110/021-000</p>
	<p>Item no.: 769-121 2-conductor female connector; 4 mm²; 1-pole</p>	<p>www.wago.com/769-121</p>
	<p>Item no.: 769-122 2-conductor female connector; 4 mm²; 2-pole</p>	<p>www.wago.com/769-122</p>
	<p>Item no.: 769-123 2-conductor female connector; 4 mm²; 3-pole</p>	<p>www.wago.com/769-123</p>

	Item no.: 769-124 2-conductor female connector; 4 mm ² ; 4-pole	www.wago.com/769-124
	Item no.: 769-125 2-conductor female connector; 4 mm ² ; 5-pole	www.wago.com/769-125
	Item no.: 769-126 2-conductor female connector; 4 mm ² ; 6-pole	www.wago.com/769-126
	Item no.: 769-127 2-conductor female connector; 4 mm ² ; 7-pole	www.wago.com/769-127
	Item no.: 769-128 2-conductor female connector; 4 mm ² ; 8-pole	www.wago.com/769-128
	Item no.: 769-129 2-conductor female connector; 4 mm ² ; 9-pole	www.wago.com/769-129
	Item no.: 769-130 2-conductor female connector; 4 mm ² ; 10-pole	www.wago.com/769-130



Protective Warning Marker

	Item no.: 280-415 Protective warning marker; with high-voltage symbol, black; for 5 terminal blocks	www.wago.com/280-415
--	---	--

assembling

	Item no.: 769-499 Fixing screw M2.5 x 16; and hexagon nut M2.5	www.wago.com/769-499
--	--	--

tools

	Item no.: 210-490 Operating tool; for female and male connectors with CAGE CLAMP® connection	www.wago.com/210-490
	Item no.: 769-434 Push-button; loose; for female and male connectors with CAGE CLAMP® connection	www.wago.com/769-434

Downloads

Documentation

Bid Text

769-610/002-000	Oct 18, 2017	DOC 25.6 kB	Download
-----------------	--------------	----------------	----------

smartDATA

CAD data

3D Download 769-610/002-000	URL	Download
-----------------------------	-----	----------



Product family

X-COM

[Learn more about the product family.](#)

[Show all products from the family](#)

Subject to changes.

WAGO Kontakttechnik GmbH & Co. KG

Hansastr. 27

32423 Minden

Phone: +49571 887-0 | Fax: +49571 887-169

Email: info.de@wago.com | Web: www.wago.com

Do you have any questions about our products?

We are always happy to take your call at +49 (571) 887-44222.