

Data sheet | Item number: 769-614/002-000

1-conductor male connector; clamping collar; 4 mm²; Pin spacing 5 mm; 14-pole

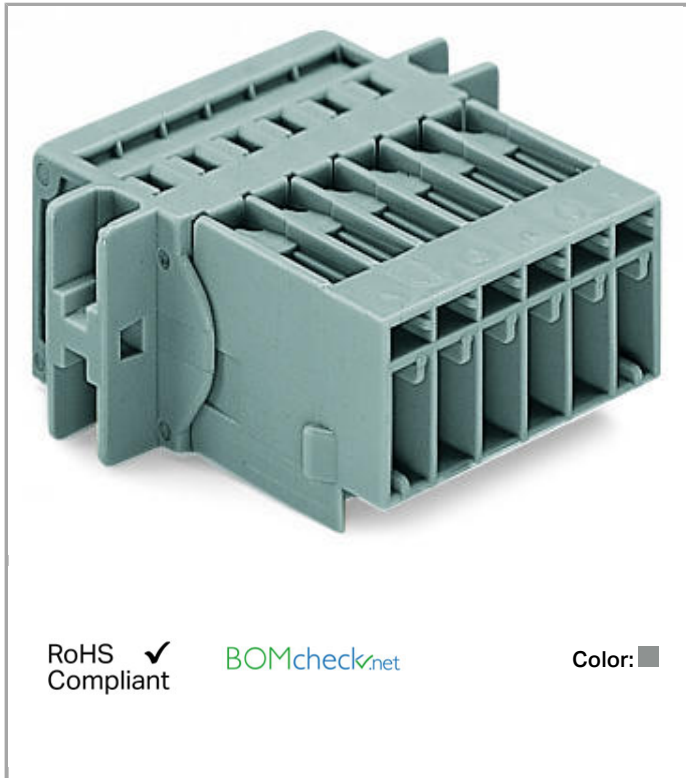

www.wago.com/769-614/002-000



RoHS Compliant

BOMcheck.net

Color: ■

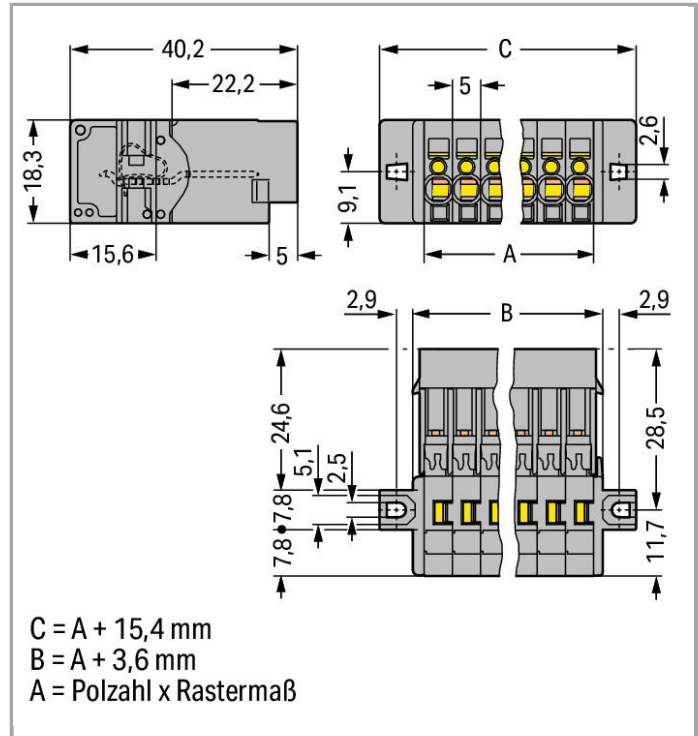

Data

Electrical data

Ratings per IEC/EN 60664-1

Rated voltage (III / 3)	500 V
Rated impulse voltage (III / 3)	6 kV
Rated current	32 A
Legend (ratings)	(III / 3) ≙ Overvoltage category III / Pollution degree 3

Connection data

Connection technology	CAGE CLAMP®
Actuation type	Operating tool
Connectable conductor materials	Copper Aluminum
Nominal cross section	4 mm ²
Solid conductor	0.08 ... 4 mm ² / 28 ... 12 AWG
Fine-stranded conductor	0.08 ... 4 mm ² / 28 ... 12 AWG



Strip length	8 ... 9 mm / 0.31 ... 0.35 Inch
No. of poles	14
Total number of connection points	14
Total number of potentials	14
Type of wiring	Front-entry wiring

Geometrical Data

Pin spacing	5 mm / 0.197 inch
Width	85.4 mm / 3.362 inch
Height from the surface	18.3 mm / 0.72 inch
Depth	40.2 mm / 1.583 inch

Mechanical data

Mounting type	Mounting flange
---------------	-----------------

Plug connection

Contact type (pluggable connector)	Male connector/plug
Connector connection type	for conductors

Material Data

Color	gray
Insulating material	Polyamide 66 (PA 66)
Fire load	0.84 MJ
Weight	41.332 g

Commercial data

Country of origin	PL
GTIN	4044918521871
Customs Tariff No.	85366990990
Product Group	18 (X-COM-System)

Approvals / Certificates

Country specific Approvals

Logo	Approval	Certificate name
	CCA DEKRA Certification B.V.	NTR NL-7626
	CSA DEKRA Certification B.V.	1101144





KEMA/KEUR

DEKRA Certification B.V.









2190419.01

UL-Approvals

Logo	Approval	Certificate name
	UR Underwriters Laboratories Inc.	E45171
	UR Underwriters Laboratories Inc.	E45172

















Compatible products

ferrule

	Item no.: 216-101 Ferrule; Sleeve for 0.5 mm ² / AWG 22; uninsulated; electro-tin plated	www.wago.com/216-101
	Item no.: 216-102 Ferrule; Sleeve for 0.75 mm ² / AWG 20; uninsulated; electro-tin plated	www.wago.com/216-102
	Item no.: 216-103 Ferrule; Sleeve for 1 mm ² / AWG 18; uninsulated; electro-tin plated	www.wago.com/216-103
	Item no.: 216-104 Ferrule; Sleeve for 1.5 mm ² / AWG 16; uninsulated; electro-tin plated	www.wago.com/216-104
	Item no.: 216-201 Ferrule; Sleeve for 0.5 mm ² / AWG 22; insulated; electro-tin plated	www.wago.com/216-201
	Item no.: 216-202 Ferrule; Sleeve for 0.75 mm ² / AWG 20; insulated; electro-tin plated	www.wago.com/216-202
	Item no.: 216-203 Ferrule; Sleeve for 1 mm ² / AWG 18; insulated; electro-tin plated	www.wago.com/216-203
	Item no.: 216-204 Ferrule; Sleeve for 1.5 mm ² / AWG 16; insulated; electro-tin plated	www.wago.com/216-204
	Item no.: 216-206 Ferrule; Sleeve for 2.5 mm ² / AWG 14; insulated; electro-tin plated	www.wago.com/216-206

Marking accessories

Item no.: 2009-145

	Mini-WSB Inline; for smartPRINTER; on reel; stretchable 5 - 5.2 mm; plain; snap-on type	www.wago.com/2009-145
	Item no.: 2009-145/000-002 Mini-WSB Inline; for smartPRINTER; on reel; stretchable 5 - 5.2 mm; plain; snap-on type	www.wago.com/2009-145/000-002
	Item no.: 2009-145/000-005 Mini-WSB Inline; for smartPRINTER; on reel; stretchable 5 - 5.2 mm; plain; snap-on type	www.wago.com/2009-145/000-005
	Item no.: 2009-145/000-006 Mini-WSB Inline; for smartPRINTER; on reel; stretchable 5 - 5.2 mm; plain; snap-on type	www.wago.com/2009-145/000-006
	Item no.: 2009-145/000-007 Mini-WSB Inline; for smartPRINTER; on reel; stretchable 5 - 5.2 mm; plain; snap-on type	www.wago.com/2009-145/000-007
	Item no.: 2009-145/000-012 Mini-WSB Inline; for smartPRINTER; on reel; stretchable 5 - 5.2 mm; plain; snap-on type	www.wago.com/2009-145/000-012
	Item no.: 2009-145/000-023 Mini-WSB Inline; for smartPRINTER; on reel; stretchable 5 - 5.2 mm; plain; snap-on type	www.wago.com/2009-145/000-023
	Item no.: 2009-145/000-024 Mini-WSB Inline; on reel; stretchable 5 - 5.2 mm; plain; snap-on type	www.wago.com/2009-145/000-024
	Item no.: 210-831 Marking strips; on reel; 2.3 mm wide; plain; Self-adhesive	www.wago.com/210-831
	Item no.: 210-832 Marking strips; on reel; 3 mm wide; plain; Self-adhesive	www.wago.com/210-832
	Item no.: 210-833 Marking strips; on reel; 6 mm wide; plain; Self-adhesive	www.wago.com/210-833
	Item no.: 210-834 Marking strips; on reel; 5 mm wide; plain; Self-adhesive	www.wago.com/210-834
	Item no.: 248-501 Miniature WSB Quick marking system; plain; Marker width 5 mm; 10 strips with 10 markers per card	www.wago.com/248-501
	Item no.: 248-501/000-002 Mini-WSB marking card; as card; not stretchable; plain; snap-on type	www.wago.com/248-501/000-002
	Item no.: 248-501/000-005 Mini-WSB marking card; as card; plain; snap-on type	www.wago.com/248-501/000-005
	Item no.: 248-501/000-006 Mini-WSB marking card; as card; not stretchable; plain; snap-on type	www.wago.com/248-501/000-006



Item no.: 248-501/000-007
Mini-WSB marking card; as card; not stretchable; plain; snap-on type

www.wago.com/248-501/000-007



Item no.: 248-501/000-012
Mini-WSB marking card; as card; not stretchable; plain; snap-on type

www.wago.com/248-501/000-012



Item no.: 248-501/000-017
Mini-WSB marking card; as card; not stretchable; plain; snap-on type

www.wago.com/248-501/000-017



Item no.: 248-501/000-023
Mini-WSB marking card; as card; not stretchable; plain; snap-on type

www.wago.com/248-501/000-023



Item no.: 248-501/000-024
Mini-WSB marking card; as card; not stretchable; plain; snap-on type

www.wago.com/248-501/000-024

Coding



Item no.: 769-435
Coding pin; for coding of female plugs; for carrier terminal blocks / male connectors

www.wago.com/769-435

Female plug



Item no.: 769-101
1-conductor female plug; 4 mm²; 1-pole

www.wago.com/769-101



Item no.: 769-101/000-016
1-conductor female plug; 4 mm²; 1-pole

www.wago.com/769-101/000-016



Item no.: 769-102
1-conductor female plug; 4 mm²; 2-pole

www.wago.com/769-102

Item no.: 769-102/000-036
1-conductor female plug; 4 mm²; 2-pole

www.wago.com/769-102/000-036

Item no.: 769-102/000-037
1-conductor female plug; 4 mm²; 2-pole

www.wago.com/769-102/000-037

Item no.: 769-103
1-conductor female plug; 4 mm²; 3-pole

www.wago.com/769-103



Item no.: 769-103/000-036
1-conductor female plug; 4 mm²; 3-pole

www.wago.com/769-103/000-036



Item no.: 769-103/000-037
1-conductor female plug; 4 mm²; 3-pole

www.wago.com/769-103/000-037



Item no.: 769-103/000-038
1-conductor female plug; 4 mm²; 3-pole

www.wago.com/769-103/000-038



Item no.: 769-103/000-039
1-conductor female plug; 4 mm²; 3-pole

www.wago.com/769-103/000-039

Item no.: 769-104
1-conductor female plug; 4 mm²; 4-pole

www.wago.com/769-104



Item no.: 769-104/000-036
1-conductor female plug; 4 mm²; 4-pole

www.wago.com/769-104/000-036



Item no.: 769-104/000-037
1-conductor female plug; 4 mm²; 4-pole

www.wago.com/769-104/000-037



Item no.: 769-104/000-038
1-conductor female plug; 4 mm²; 4-pole

www.wago.com/769-104/000-038



Item no.: 769-104/000-039
1-conductor female plug; 4 mm²; 4-pole

www.wago.com/769-104/000-039



Item no.: 769-105
1-conductor female plug; 4 mm²; 5-pole

www.wago.com/769-105



Item no.: 769-105/000-036
1-conductor female plug; 4 mm²; 5-pole

www.wago.com/769-105/000-036



Item no.: 769-105/000-037
1-conductor female plug; 4 mm²; 5-pole

www.wago.com/769-105/000-037



Item no.: 769-105/000-038
1-conductor female plug; 4 mm²; 5-pole

www.wago.com/769-105/000-038



Item no.: 769-105/000-039
1-conductor female plug; 4 mm²; 5-pole

www.wago.com/769-105/000-039

Item no.: 769-106
1-conductor female plug; 4 mm²; 6-pole

www.wago.com/769-106

Item no.: 769-106/000-006
1-conductor female plug; 4 mm²; 6-pole

www.wago.com/769-106/000-006



Item no.: 769-106/000-036
1-conductor female plug; 4 mm²; 6-pole

www.wago.com/769-106/000-036



Item no.: 769-106/000-037
1-conductor female plug; 4 mm²; 6-pole

www.wago.com/769-106/000-037



Item no.: 769-106/000-038
1-conductor female plug; 4 mm²; 6-pole

www.wago.com/769-106/000-038



Item no.: 769-106/000-039
1-conductor female plug; 4 mm²; 6-pole

www.wago.com/769-106/000-039

Item no.: 769-107
1-conductor female plug; 4 mm²; 7-pole

www.wago.com/769-107



Item no.: 769-107/000-036
1-conductor female plug; 4 mm²; 7-pole

www.wago.com/769-107/000-036



Item no.: 769-107/000-037
1-conductor female plug; 4 mm²; 7-pole

www.wago.com/769-107/000-037



Item no.: 769-107/000-038
1-conductor female plug; 4 mm²; 7-pole

www.wago.com/769-107/000-038



Item no.: 769-107/000-039
1-conductor female plug; 4 mm²; 7-pole

www.wago.com/769-107/000-039

Item no.: 769-108
1-conductor female plug; 4 mm²; 8-pole

www.wago.com/769-108

Item no.: 769-108/000-036
1-conductor female plug; 4 mm²; 8-pole

www.wago.com/769-108/000-036

Item no.: 769-108/000-037
1-conductor female plug; 4 mm²; 8-pole

www.wago.com/769-108/000-037

Item no.: 769-108/000-038
1-conductor female plug; 4 mm²; 8-pole

www.wago.com/769-108/000-038

Item no.: 769-108/000-039
1-conductor female plug; 4 mm²; 8-pole

www.wago.com/769-108/000-039

Item no.: 769-109
1-conductor female plug; 4 mm²; 9-pole

www.wago.com/769-109



Item no.: 769-109/000-036
1-conductor female plug; 4 mm²; 9-pole

www.wago.com/769-109/000-036



Item no.: 769-109/000-037
1-conductor female plug; 4 mm²; 9-pole

www.wago.com/769-109/000-037

Item no.: 769-109/000-038
1-conductor female plug; 4 mm²; 9-pole

www.wago.com/769-109/000-038



Item no.: 769-109/000-039
1-conductor female plug; 4 mm²; 9-pole

www.wago.com/769-109/000-039



Item no.: 769-110
1-conductor female plug; 4 mm²; 10-pole

www.wago.com/769-110

Item no.: 769-110/000-036
1-conductor female plug; 4 mm²; 10-pole

www.wago.com/769-110/000-036

Item no.: 769-110/000-037
1-conductor female plug; 4 mm²; 10-pole

www.wago.com/769-110/000-037

Item no.: 769-110/000-038
1-conductor female plug; 4 mm²; 10-pole

www.wago.com/769-110/000-038

Item no.: 769-110/000-039
1-conductor female plug; 4 mm²; 10-pole

www.wago.com/769-110/000-039

Item no.: 769-111
1-conductor female plug; 4 mm²; 11-pole

www.wago.com/769-111

Item no.: 769-111/000-036
1-conductor female plug; 4 mm²; 11-pole

www.wago.com/769-111/000-036

Item no.: 769-111/000-037
1-conductor female plug; 4 mm²; 11-pole

www.wago.com/769-111/000-037

Item no.: 769-111/000-038
1-conductor female plug; 4 mm²; 11-pole

www.wago.com/769-111/000-038

Item no.: 769-111/000-039
1-conductor female plug; 4 mm²; 11-pole

www.wago.com/769-111/000-039

Item no.: 769-112
1-conductor female plug; 4 mm²; 12-pole

www.wago.com/769-112



Item no.: 769-112/000-036
1-conductor female plug; 4 mm²; 12-pole

www.wago.com/769-112/000-036



Item no.: 769-112/000-037
1-conductor female plug; 4 mm²; 12-pole

www.wago.com/769-112/000-037



Item no.: 769-112/000-038
1-conductor female plug; 4 mm²; 12-pole

www.wago.com/769-112/000-038



Item no.: 769-112/000-039
1-conductor female plug; 4 mm²; 12-pole

www.wago.com/769-112/000-039

Item no.: 769-113
1-conductor female plug; 4 mm²; 13-pole

www.wago.com/769-113

Item no.: 769-113/000-036
1-conductor female plug; 4 mm²; 13-pole

www.wago.com/769-113/000-036

Item no.: 769-113/000-037
1-conductor female plug; 4 mm²; 13-pole

www.wago.com/769-113/000-037

Item no.: 769-113/000-038
1-conductor female plug; 4 mm²; 13-pole

www.wago.com/769-113/000-038

Item no.: 769-113/000-039
1-conductor female plug; 4 mm²; 13-pole

www.wago.com/769-113/000-039

Item no.: 769-114
1-conductor female plug; 4 mm²; 14-pole

www.wago.com/769-114

Item no.: 769-114/000-036
1-conductor female plug; 4 mm²; 14-pole

www.wago.com/769-114/000-036

Item no.: 769-114/000-037
1-conductor female plug; 4 mm²; 14-pole

www.wago.com/769-114/000-037

Item no.: 769-114/000-038
1-conductor female plug; 4 mm²; 14-pole

www.wago.com/769-114/000-038

Item no.: 769-114/000-039
1-conductor female plug; 4 mm²; 14-pole

www.wago.com/769-114/000-039

Item no.: 769-114/021-000
1-conductor female plug; Locking lever; 4 mm²; 14-pole

www.wago.com/769-114/021-000



Item no.: 769-121
2-conductor female connector; 4 mm²; 1-pole

www.wago.com/769-121



Item no.: 769-122
2-conductor female connector; 4 mm²; 2-pole

www.wago.com/769-122

Item no.: 769-123
2-conductor female connector; 4 mm²; 3-pole

www.wago.com/769-123

Item no.: 769-124
2-conductor female connector; 4 mm²; 4-pole

www.wago.com/769-124



Item no.: 769-125
2-conductor female connector; 4 mm²; 5-pole

www.wago.com/769-125

Item no.: 769-126
2-conductor female connector; 4 mm²; 6-pole

www.wago.com/769-126

Item no.: 769-127
2-conductor female connector; 4 mm²; 7-pole

www.wago.com/769-127

Item no.: 769-128
2-conductor female connector; 4 mm²; 8-pole

www.wago.com/769-128

Item no.: 769-129
2-conductor female connector; 4 mm²; 9-pole

www.wago.com/769-129

Item no.: 769-130
2-conductor female connector; 4 mm²; 10-pole

www.wago.com/769-130

Item no.: 769-131
2-conductor female connector; 4 mm²; 11-pole

www.wago.com/769-131

Item no.: 769-132
2-conductor female connector; 4 mm²; 12-pole

www.wago.com/769-132

Item no.: 769-133
2-conductor female connector; 4 mm²; 13-pole

www.wago.com/769-133

Item no.: 769-134
2-conductor female connector; 4 mm²; 14-pole

www.wago.com/769-134

assembling



Item no.: 769-499
Fixing screw M2.5 x 16; and hexagon nut M2.5

www.wago.com/769-499

Insulation stop



Item no.: 769-470
Insulation stop; 0.08 - 0.2 mm² "s" (0.14 mm² "f-st"); 5 pieces/strip

www.wago.com/769-470



Item no.: 769-471
Insulation stop; 0.25 - 0.5 mm²; 5 pieces/strip

www.wago.com/769-471



Item no.: 769-472
Insulation stop; 0.75 - 1 mm²; 5 pieces/strip

www.wago.com/769-472

tools



Item no.: 210-490
Operating tool; for female and male connectors with CAGE CLAMP® connection

www.wago.com/210-490



Item no.: 769-434
Push-button; loose; for female and male connectors with CAGE CLAMP® connection

www.wago.com/769-434

Protective Warning Marker



Item no.: 280-415
Protective warning marker; with high-voltage symbol, black; for 5 terminal blocks

www.wago.com/280-415



Downloads

Documentation

Bid Text

769-614/002-000	Oct 18, 2017	DOC 25.6 kB	Download
-----------------	--------------	----------------	----------

smartDATA

CAD data

3D Download 769-614/002-000	URL	Download
-----------------------------	-----	----------

Product family

X-COM

[Learn more about the product family.](#)

[Show all products from the family](#)

Subject to changes.