

Data sheet | Item number: 769-635

THT male header; 1.0 x 1.0 mm solder pin; straight; Pin spacing 5 mm; 5-pole

www.wago.com/769-635

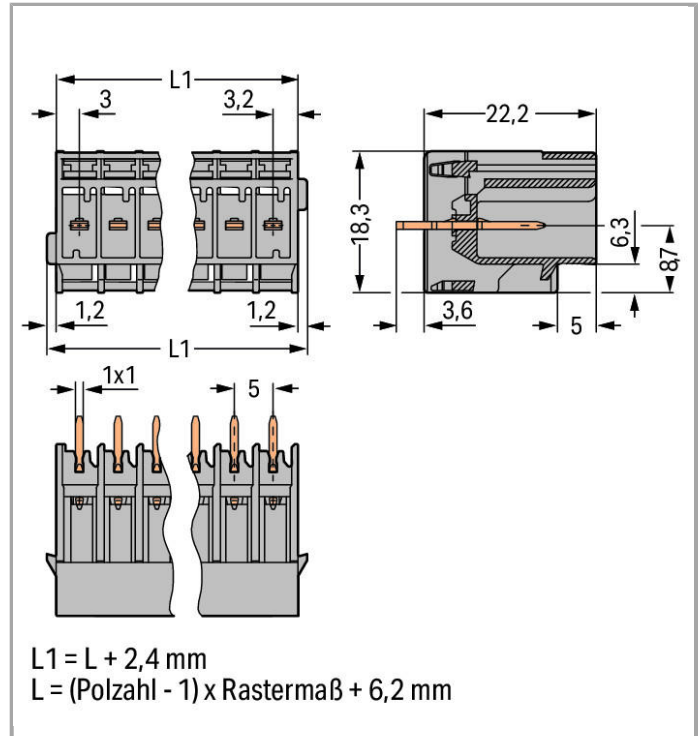
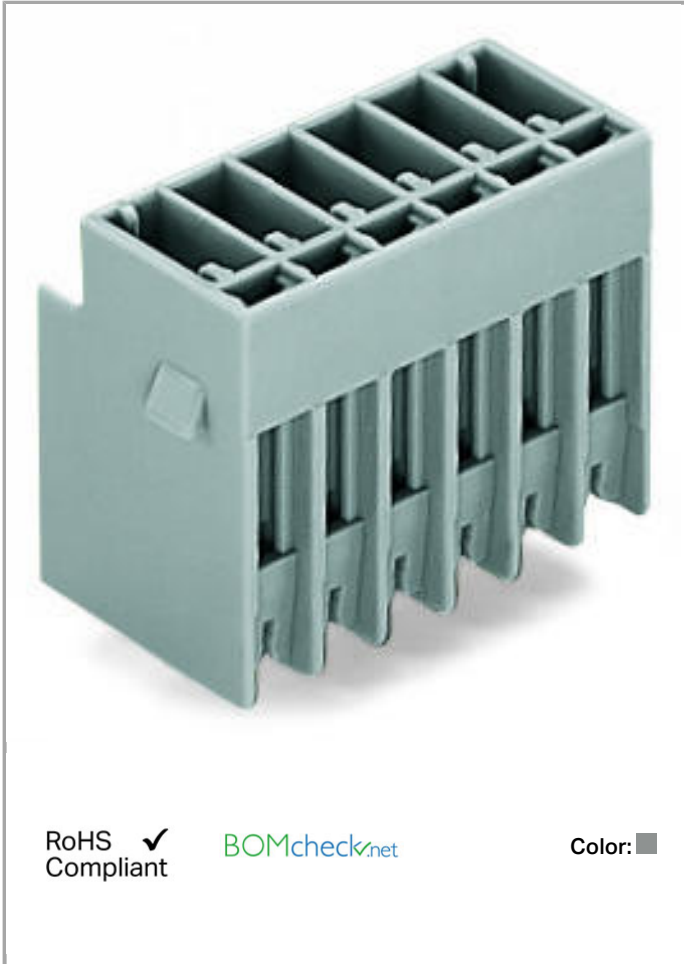

RoHS Compliant

BOMcheck.net

Color: ■

Data

Electrical data

Ratings per IEC/EN 60664-1

Rated voltage (III / 3)	250 V
Rated impulse voltage (III / 3)	4 kV
Rated voltage (III / 2)	500 V
Rated impulse voltage (III / 2)	4 kV
Rated current	32 A
Legend (ratings)	(III / 3) ≙ Overvoltage category III / Pollution degree 3



Connection data

Actuation type	Operating tool
No. of poles	5
Total number of potentials	5
Number of levels	1

Geometrical Data

Pin spacing	5 mm / 0.197 inch
Width	28.6 mm / 1.126 inch
Height from the surface	22.2 mm / 0.874 inch
Depth	18.3 mm / 0.72 inch
Solder pin dimensions	Solder pin 1 x 1 mm

Plug connection

Contact type (pluggable connector)	Male connector/plug
Connector connection type	for PCBs
Mismating protection	No
Mating direction to the PCB	90°

PCB contact

PCB contact	THT
-------------	-----

Material Data

Color	gray
Insulating material	Polyamide 66 (PA 66)
Fire load	0.113 MJ
Weight	5.267 g

Commercial data

Country of origin	DE
GTIN	4044918270656
Customs Tariff No.	85366990990
Product Group	18 (X-COM-System)

Approvals / Certificates

Country specific Approvals

Logo	Approval	Certificate name
	CCA	NTR NL-7626



DEKRA Certification B.V.



CSA
DEKRA Certification B.V.

1101144

KEMA/KEUR
DEKRA Certification B.V.

2190419.01

UL-Approvals

Logo	Approval	Certificate name
	UR Underwriters Laboratories Inc.	E45172
	UR Underwriters Laboratories Inc.	E45171

Compatible products



Marking accessories











	Item no.: 210-831 Marking strips; on reel; 2.3 mm wide; plain; Self-adhesive	www.wago.com/210-831
	Item no.: 210-832 Marking strips; on reel; 3 mm wide; plain; Self-adhesive	www.wago.com/210-832
	Item no.: 210-833 Marking strips; on reel; 6 mm wide; plain; Self-adhesive	www.wago.com/210-833
	Item no.: 210-834 Marking strips; on reel; 5 mm wide; plain; Self-adhesive	www.wago.com/210-834

Coding

	Item no.: 769-435 Coding pin; for coding of female plugs; for carrier terminal blocks / male connectors	www.wago.com/769-435
--	---	--

Female plug

	Item no.: 769-101 1-conductor female plug; 4 mm ² ; 1-pole	www.wago.com/769-101
	Item no.: 769-102 1-conductor female plug; 4 mm ² ; 2-pole	www.wago.com/769-102

	Item no.: 769-102/000-036 1-conductor female plug; 4 mm ² ; 2-pole	www.wago.com/769-102/000-036
	Item no.: 769-102/000-037 1-conductor female plug; 4 mm ² ; 2-pole	www.wago.com/769-102/000-037
	Item no.: 769-103 1-conductor female plug; 4 mm ² ; 3-pole	www.wago.com/769-103
	Item no.: 769-103/000-036 1-conductor female plug; 4 mm ² ; 3-pole	www.wago.com/769-103/000-036
	Item no.: 769-103/000-037 1-conductor female plug; 4 mm ² ; 3-pole	www.wago.com/769-103/000-037
	Item no.: 769-103/000-038 1-conductor female plug; 4 mm ² ; 3-pole	www.wago.com/769-103/000-038
	Item no.: 769-103/000-039 1-conductor female plug; 4 mm ² ; 3-pole	www.wago.com/769-103/000-039
	Item no.: 769-104 1-conductor female plug; 4 mm ² ; 4-pole	www.wago.com/769-104
	Item no.: 769-104/000-036 1-conductor female plug; 4 mm ² ; 4-pole	www.wago.com/769-104/000-036
	Item no.: 769-104/000-037 1-conductor female plug; 4 mm ² ; 4-pole	www.wago.com/769-104/000-037
	Item no.: 769-104/000-038 1-conductor female plug; 4 mm ² ; 4-pole	www.wago.com/769-104/000-038
	Item no.: 769-104/000-039 1-conductor female plug; 4 mm ² ; 4-pole	www.wago.com/769-104/000-039
	Item no.: 769-105 1-conductor female plug; 4 mm ² ; 5-pole	www.wago.com/769-105
	Item no.: 769-105/000-036 1-conductor female plug; 4 mm ² ; 5-pole	www.wago.com/769-105/000-036
	Item no.: 769-105/000-037 1-conductor female plug; 4 mm ² ; 5-pole	www.wago.com/769-105/000-037



Item no.: 769-105/000-038
1-conductor female plug; 4 mm²; 5-pole

www.wago.com/769-105/000-038



Item no.: 769-105/000-039
1-conductor female plug; 4 mm²; 5-pole

www.wago.com/769-105/000-039



Item no.: 769-105/021-000
1-conductor female plug; Locking lever; 4 mm²; 5-pole

www.wago.com/769-105/021-000



Item no.: 769-121
2-conductor female connector; 4 mm²; 1-pole

www.wago.com/769-121



Item no.: 769-122
2-conductor female connector; 4 mm²; 2-pole

www.wago.com/769-122

Item no.: 769-123
2-conductor female connector; 4 mm²; 3-pole

www.wago.com/769-123

Item no.: 769-124
2-conductor female connector; 4 mm²; 4-pole

www.wago.com/769-124



Item no.: 769-125
2-conductor female connector; 4 mm²; 5-pole

www.wago.com/769-125

Downloads

Documentation

Bid Text

769-635	Oct 18, 2017	DOC 25.6 kB	Download
---------	--------------	----------------	----------

smartDATA

CAD data

3D Download 769-635	URL	Download
---------------------	-----	----------

Product family

X-COM

[Learn more about the product family.](#)

[Show all products from the family](#)



Subject to changes.

WAGO Kontakttechnik GmbH & Co. KG
Hansastr. 27
32423 Minden
Phone: +49571 887-0 | Fax: +49571 887-169
Email: info.de@wago.com | Web: www.wago.com

Do you have any questions about our products?
We are always happy to take your call at +49 (571) 887-44222.