

Data sheet | Item number: 781-631

3-conductor through terminal block; 4 mm<sup>2</sup>; center marking; for DIN-rail 35 x 15 and 35 x 7.5; CAGE CLAMP®

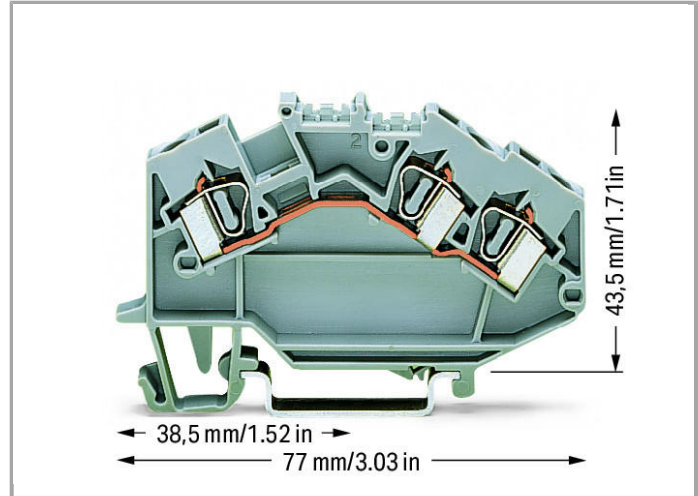

[www.wago.com/781-631](http://www.wago.com/781-631)

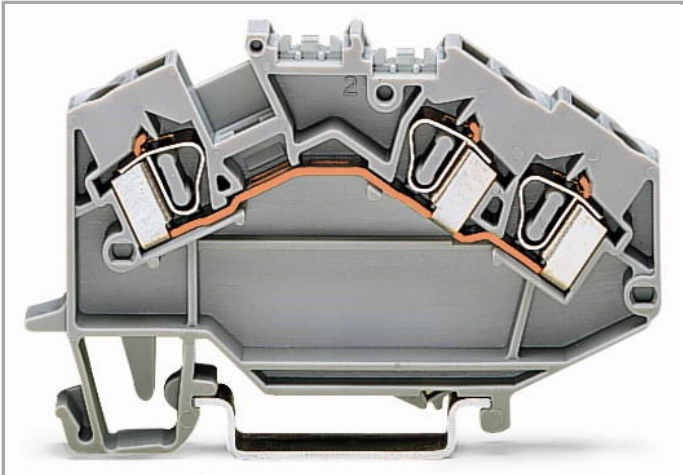

RoHS  Compliant

[BOMcheck.net](http://BOMcheck.net)

Color: ■

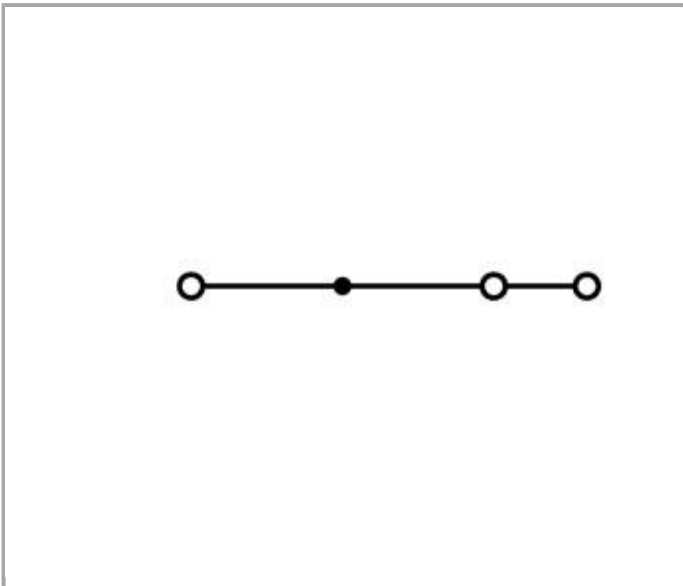

Data  
Electrical data



### Ratings per IEC/EN 60664-1

Rated voltage (III / 3)	1000 V
Rated impulse voltage (III / 3)	8 kV
Rated current	32 A
Legend (ratings)	(III / 3) $\triangleq$ Overvoltage category III / Pollution degree 3

### Connection data

Connection technology	CAGE CLAMP®
Actuation type	Operating tool
Connectable conductor materials	Copper Aluminum
Solid conductor	0.08 ... 4 mm <sup>2</sup> / 28 ... 12 AWG
Fine-stranded conductor	0.08 ... 4 mm <sup>2</sup> / 28 ... 12 AWG
Strip length	9 ... 10 mm / 0.35 ... 0.39 Inch
Total number of connection points	3
Total number of potentials	1
Number of levels	1
Type of wiring	Front-entry wiring

### Geometrical Data

Width	6 mm / 0.236 inch
Height from upper-edge of DIN-35 rail	43.5 mm / 1.713 inch
Depth	77 mm / 3.031 inch

### Mechanical data

Design	angled
Type of mounting	DIN-35 rail
Marking level	Center marking

### Material Data

Color	gray
Insulating material	Polyamide 66 (PA 66)
Fire load	0.211 MJ
Weight	11.706 g

### Commercial data



Country of origin	DE
GTIN	4044918501231

Customs Tariff No.



8536901000

## Approvals / Certificates

### Country specific Approvals

Logo	Approval	Certificate name
	<b>CCA</b> DEKRA Certification B.V.	NTR NL-7454/A1
	<b>CSA</b> DEKRA Certification B.V.	1833819

### Ship Approvals

Logo	Approval	Certificate name
	<b>ABS</b> American Bureau of Shipping	14-HG1293677-PDA
	<b>BV</b> Bureau Veritas S.A.	07436/E0 BV
	<b>LR</b> Lloyds Register	91/20112 (E9)

### UL-Approvals

Logo	Approval	Certificate name
	<b>UR</b> Underwriters Laboratories Inc.	E45172











## Compatible products

### check

	<b>Item no.: 209-170</b> Test plug adapter; 8.3 mm wide; for 4 mm Ø test plugs; suitable for 1.5 mm <sup>2</sup> - 10 mm <sup>2</sup> tbs	<a href="http://www.wago.com/209-170">www.wago.com/209-170</a>
---	--	--

### Carrier rail







	<b>Item no.: 210-112</b> Steel carrier rail; 35 x 7.5 mm; 1 mm thick; 2 m long; slotted; according to EN 60715; "Hole width 25 mm	<a href="http://www.wago.com/210-112">www.wago.com/210-112</a>
--	--	--



















	<b>Item no.: 210-113</b> Steel carrier rail; 35 x 7.5 mm; 1 mm thick; 2 m long; unslotted; according to EN 60715	<a href="http://www.wago.com/210-113">www.wago.com/210-113</a>
	<b>Item no.: 210-114</b> Steel carrier rail; 35 x 15 mm; 1.5 mm thick; 2 m long; unslotted; similar to EN 60715	<a href="http://www.wago.com/210-114">www.wago.com/210-114</a>
	<b>Item no.: 210-115</b> Steel carrier rail; 35 x 7.5 mm; 1 mm thick; 2 m long; slotted; according to EN 60715; "Hole width 18 mm	<a href="http://www.wago.com/210-115">www.wago.com/210-115</a>
	<b>Item no.: 210-118</b> Steel carrier rail; 35 x 15 mm; 2.3 mm thick; 2 m long; unslotted; according to EN 60715	<a href="http://www.wago.com/210-118">www.wago.com/210-118</a>
	<b>Item no.: 210-196</b> Aluminum carrier rail; 35 x 8.2 mm; 1.6 mm thick; 2 m long; unslotted; similar to EN 60715	<a href="http://www.wago.com/210-196">www.wago.com/210-196</a>
	<b>Item no.: 210-197</b> Steel carrier rail; 35 x 15 mm; 1.5 mm thick; 2 m long; slotted; similar to EN 60715	<a href="http://www.wago.com/210-197">www.wago.com/210-197</a>
	<b>Item no.: 210-198</b> Copper carrier rail; 35 x 15 mm; 2.3 mm thick; 2 m long; unslotted; according to EN 60715	<a href="http://www.wago.com/210-198">www.wago.com/210-198</a>
	<b>Item no.: 210-504</b> Steel carrier rail; 35 x 7.5 mm; 1 mm thick; 2 m long; slotted; galvanized; according to EN 60715	<a href="http://www.wago.com/210-504">www.wago.com/210-504</a>
	<b>Item no.: 210-505</b> Steel carrier rail; 35 x 7.5 mm; 1 mm thick; 2 m long; unslotted; galvanized; according to EN 60715	<a href="http://www.wago.com/210-505">www.wago.com/210-505</a>
	<b>Item no.: 210-506</b> Steel carrier rail; 35 x 15 mm; 1.5 mm thick; 2 m long; unslotted; galvanized; similar to EN 60715	<a href="http://www.wago.com/210-506">www.wago.com/210-506</a>
	<b>Item no.: 210-508</b> Steel carrier rail; 35 x 15 mm; 1.5 mm thick; 2 m long; slotted; galvanized; similar to EN 60715	<a href="http://www.wago.com/210-508">www.wago.com/210-508</a>















#### Protective Warning Marker

















	<b>Item no.: 281-415</b> Protective warning marker; with high-voltage symbol, black; for 5 terminal blocks	<a href="http://www.wago.com/281-415">www.wago.com/281-415</a>
--	---	--















#### ferrule

	<b>Item no.: 216-101</b> Ferrule; Sleeve for 0.5 mm <sup>2</sup> / AWG 22; uninsulated; electro-tin plated	<a href="http://www.wago.com/216-101">www.wago.com/216-101</a>
	<b>Item no.: 216-102</b> Ferrule; Sleeve for 0.75 mm <sup>2</sup> / AWG 20; uninsulated; electro-tin plated	<a href="http://www.wago.com/216-102">www.wago.com/216-102</a>
	<b>Item no.: 216-103</b> Ferrule; Sleeve for 1 mm <sup>2</sup> / AWG 18; uninsulated; electro-tin plated	<a href="http://www.wago.com/216-103">www.wago.com/216-103</a>
	<b>Item no.: 216-104</b> Ferrule; Sleeve for 1.5 mm <sup>2</sup> / AWG 16; uninsulated; electro-tin plated	<a href="http://www.wago.com/216-104">www.wago.com/216-104</a>
	<b>Item no.: 216-106</b> Ferrule; Sleeve for 2.5 mm <sup>2</sup> / AWG 14; uninsulated; electro-tin plated	<a href="http://www.wago.com/216-106">www.wago.com/216-106</a>
	<b>Item no.: 216-107</b> Ferrule; Sleeve for 4 mm <sup>2</sup> / AWG 12; uninsulated; electro-tin plated	<a href="http://www.wago.com/216-107">www.wago.com/216-107</a>
	<b>Item no.: 216-121</b>	

	Ferrule; Sleeve for 0.5 mm <sup>2</sup> / AWG 22; uninsulated; electro-tin plated	<a href="http://www.wago.com/216-121">www.wago.com/216-121</a>
	<b>Item no.: 216-122</b> Ferrule; Sleeve for 0.75 mm <sup>2</sup> / AWG 20; uninsulated; electro-tin plated	<a href="http://www.wago.com/216-122">www.wago.com/216-122</a>
	<b>Item no.: 216-123</b> Ferrule; Sleeve for 1 mm <sup>2</sup> / AWG 18; uninsulated; electro-tin plated	<a href="http://www.wago.com/216-123">www.wago.com/216-123</a>
	<b>Item no.: 216-124</b> Ferrule; Sleeve for 1.5 mm <sup>2</sup> / AWG 16; uninsulated; electro-tin plated	<a href="http://www.wago.com/216-124">www.wago.com/216-124</a>
	<b>Item no.: 216-131</b> Ferrule; Sleeve for 0.25 mm <sup>2</sup> / AWG 24; uninsulated; electro-tin plated	<a href="http://www.wago.com/216-131">www.wago.com/216-131</a>
	<b>Item no.: 216-132</b> Ferrule; Sleeve for 0.34 mm <sup>2</sup> / AWG 24; uninsulated; electro-tin plated	<a href="http://www.wago.com/216-132">www.wago.com/216-132</a>
	<b>Item no.: 216-141</b> Ferrule; Sleeve for 0.5 mm <sup>2</sup> / AWG 22; uninsulated; electro-tin plated; electrolytic copper; gastight crimped; acc. to DIN 46228, Part 1/08.92	<a href="http://www.wago.com/216-141">www.wago.com/216-141</a>
	<b>Item no.: 216-142</b> Ferrule; Sleeve for 0.75 mm <sup>2</sup> / AWG 20; uninsulated; electro-tin plated; electrolytic copper; gastight crimped; acc. to DIN 46228, Part 1/08.92	<a href="http://www.wago.com/216-142">www.wago.com/216-142</a>
	<b>Item no.: 216-143</b> Ferrule; Sleeve for 1 mm <sup>2</sup> / AWG 18; uninsulated; electro-tin plated; electrolytic copper; gastight crimped; acc. to DIN 46228, Part 1/08.92	<a href="http://www.wago.com/216-143">www.wago.com/216-143</a>
	<b>Item no.: 216-144</b> Ferrule; Sleeve for 1.5 mm <sup>2</sup> / AWG 16; uninsulated; electro-tin plated; electrolytic copper; gastight crimped; acc. to DIN 46228, Part 1/08.92	<a href="http://www.wago.com/216-144">www.wago.com/216-144</a>
	<b>Item no.: 216-151</b> Ferrule; Sleeve for 0.25 mm <sup>2</sup> / AWG 24; uninsulated; electro-tin plated	<a href="http://www.wago.com/216-151">www.wago.com/216-151</a>
	<b>Item no.: 216-152</b> Ferrule; Sleeve for 0.34 mm <sup>2</sup> / AWG 24; uninsulated; electro-tin plated	<a href="http://www.wago.com/216-152">www.wago.com/216-152</a>
	<b>Item no.: 216-201</b> Ferrule; Sleeve for 0.5 mm <sup>2</sup> / AWG 22; insulated; electro-tin plated	<a href="http://www.wago.com/216-201">www.wago.com/216-201</a>
	<b>Item no.: 216-202</b> Ferrule; Sleeve for 0.75 mm <sup>2</sup> / AWG 20; insulated; electro-tin plated	<a href="http://www.wago.com/216-202">www.wago.com/216-202</a>
	<b>Item no.: 216-203</b> Ferrule; Sleeve for 1 mm <sup>2</sup> / AWG 18; insulated; electro-tin plated	<a href="http://www.wago.com/216-203">www.wago.com/216-203</a>
	<b>Item no.: 216-204</b> Ferrule; Sleeve for 1.5 mm <sup>2</sup> / AWG 16; insulated; electro-tin plated	<a href="http://www.wago.com/216-204">www.wago.com/216-204</a>
	<b>Item no.: 216-205</b> Ferrule; Sleeve for 2.08 mm <sup>2</sup> / AWG 14; insulated; electro-tin plated	<a href="http://www.wago.com/216-205">www.wago.com/216-205</a>
	<b>Item no.: 216-206</b> Ferrule; Sleeve for 2.5 mm <sup>2</sup> / AWG 14; insulated; electro-tin plated	<a href="http://www.wago.com/216-206">www.wago.com/216-206</a>
	<b>Item no.: 216-207</b> Ferrule; Sleeve for 4 mm <sup>2</sup> / AWG 12; insulated; electro-tin plated	<a href="http://www.wago.com/216-207">www.wago.com/216-207</a>
	<b>Item no.: 216-221</b>	

	Ferrule; Sleeve for 0.5 mm <sup>2</sup> / AWG 22; insulated; electro-tin plated	<a href="http://www.wago.com/216-221">www.wago.com/216-221</a>
	<b>Item no.: 216-222</b> Ferrule; Sleeve for 0.75 mm <sup>2</sup> / AWG 20; insulated; electro-tin plated	<a href="http://www.wago.com/216-222">www.wago.com/216-222</a>
	<b>Item no.: 216-223</b> Ferrule; Sleeve for 1 mm <sup>2</sup> / AWG 18; insulated; electro-tin plated	<a href="http://www.wago.com/216-223">www.wago.com/216-223</a>
	<b>Item no.: 216-224</b> Ferrule; Sleeve for 1.5 mm <sup>2</sup> / AWG 16; insulated; electro-tin plated	<a href="http://www.wago.com/216-224">www.wago.com/216-224</a>
	<b>Item no.: 216-241</b> Ferrule; Sleeve for 0.5 mm <sup>2</sup> / AWG 22; insulated; electro-tin plated; electrolytic copper; gastight crimped; acc. to DIN 46228, Part 4/09.90	<a href="http://www.wago.com/216-241">www.wago.com/216-241</a>
	<b>Item no.: 216-242</b> Ferrule; Sleeve for 0.75 mm <sup>2</sup> / AWG 20; insulated; electro-tin plated; electrolytic copper; gastight crimped; acc. to DIN 46228, Part 4/09.90	<a href="http://www.wago.com/216-242">www.wago.com/216-242</a>
	<b>Item no.: 216-243</b> Ferrule; Sleeve for 1 mm <sup>2</sup> / AWG 18; insulated; electro-tin plated; electrolytic copper; gastight crimped; acc. to DIN 46228, Part 4/09.90	<a href="http://www.wago.com/216-243">www.wago.com/216-243</a>
	<b>Item no.: 216-244</b> Ferrule; Sleeve for 1.5 mm <sup>2</sup> / AWG 16; insulated; electro-tin plated; electrolytic copper; gastight crimped; acc. to DIN 46228, Part 4/09.90	<a href="http://www.wago.com/216-244">www.wago.com/216-244</a>
	<b>Item no.: 216-246</b> Ferrule; Sleeve for 2.5 mm <sup>2</sup> / AWG 14; insulated; electro-tin plated; electrolytic copper; gastight crimped; acc. to DIN 46228, Part 4/09.90	<a href="http://www.wago.com/216-246">www.wago.com/216-246</a>
	<b>Item no.: 216-262</b> Ferrule; Sleeve for 0.75 mm <sup>2</sup> / AWG 20; insulated; electro-tin plated; electrolytic copper; gastight crimped; acc. to DIN 46228, Part 4/09.90	<a href="http://www.wago.com/216-262">www.wago.com/216-262</a>
	<b>Item no.: 216-263</b> Ferrule; Sleeve for 1 mm <sup>2</sup> / AWG 18; insulated; electro-tin plated; electrolytic copper; gastight crimped; acc. to DIN 46228, Part 4/09.90	<a href="http://www.wago.com/216-263">www.wago.com/216-263</a>
	<b>Item no.: 216-264</b> Ferrule; Sleeve for 1.5 mm <sup>2</sup> / AWG 16; insulated; electro-tin plated; electrolytic copper; gastight crimped; acc. to DIN 46228, Part 4/09.90	<a href="http://www.wago.com/216-264">www.wago.com/216-264</a>
	<b>Item no.: 216-266</b> Ferrule; Sleeve for 2.5 mm <sup>2</sup> / AWG 14; insulated; electro-tin plated; electrolytic copper; gastight crimped; acc. to DIN 46228, Part 4/09.90	<a href="http://www.wago.com/216-266">www.wago.com/216-266</a>
	<b>Item no.: 216-267</b> Ferrule; Sleeve for 4 mm <sup>2</sup> / AWG 12; insulated; electro-tin plated; electrolytic copper; gastight crimped; acc. to DIN 46228, Part 4/09.90	<a href="http://www.wago.com/216-267">www.wago.com/216-267</a>
	<b>Item no.: 216-284</b> Ferrule; Sleeve for 1.5 mm <sup>2</sup> / AWG 16; insulated; electro-tin plated; electrolytic copper; gastight crimped; acc. to DIN 46228, Part 4/09.90	<a href="http://www.wago.com/216-284">www.wago.com/216-284</a>
	<b>Item no.: 216-286</b> Ferrule; Sleeve for 2.5 mm <sup>2</sup> / AWG 14; insulated; electro-tin plated; electrolytic copper; gastight crimped; acc. to DIN 46228, Part 4/09.90	<a href="http://www.wago.com/216-286">www.wago.com/216-286</a>
	<b>Item no.: 216-287</b> Ferrule; Sleeve for 4 mm <sup>2</sup> / AWG 12; insulated; electro-tin plated; electrolytic copper; gastight crimped; acc. to DIN 46228, Part 4/09.90	<a href="http://www.wago.com/216-287">www.wago.com/216-287</a>
	<b>Item no.: 216-301</b> Ferrule; Sleeve for 0.25 mm <sup>2</sup> / AWG 24; insulated; electro-tin plated	<a href="http://www.wago.com/216-301">www.wago.com/216-301</a>



	<b>Item no.: 216-302</b> Ferrule; Sleeve for 0.34 mm <sup>2</sup> / AWG 24; insulated; electro-tin plated	<a href="http://www.wago.com/216-302">www.wago.com/216-302</a>
	<b>Item no.: 216-321</b> Ferrule; Sleeve for 0.25 mm <sup>2</sup> / AWG 24; insulated; electro-tin plated	<a href="http://www.wago.com/216-321">www.wago.com/216-321</a>
	<b>Item no.: 216-322</b> Ferrule; Sleeve for 0.34 mm <sup>2</sup> / AWG 24; insulated; electro-tin plated	<a href="http://www.wago.com/216-322">www.wago.com/216-322</a>
<b>General accessories</b>		
	<b>Item no.: 249-105</b> Group marker carrier	<a href="http://www.wago.com/249-105">www.wago.com/249-105</a>
	<b>Item no.: 249-147</b> B-type test plug module; modular	<a href="http://www.wago.com/249-147">www.wago.com/249-147</a>
	<b>Item no.: 249-148</b> B-type spacer module; modular; e.g., for bridging commoned terminal blocks	<a href="http://www.wago.com/249-148">www.wago.com/249-148</a>
	<b>Item no.: 280-404</b> Test plug adapter; 5 mm wide; for test plug 210-137 (2.3 mm Ø); suitable for 1.5 mm <sup>2</sup> - 4 mm <sup>2</sup> tbs	<a href="http://www.wago.com/280-404">www.wago.com/280-404</a>
	<b>Item no.: 281-407</b> Test plug; 6 mm wide; Nominal current 24 A; for 0.08 mm <sup>2</sup> - 2.5 mm <sup>2</sup>	<a href="http://www.wago.com/281-407">www.wago.com/281-407</a>
	<b>Item no.: 281-418</b> Test plug module; modular; suitable for all WAGO 281, 776, 777 and 781 series rail-mounted terminal blocks with jumper slots in the current bar	<a href="http://www.wago.com/281-418">www.wago.com/281-418</a>
	<b>Item no.: 281-419</b> Spacer module; modular; bridging commoned terminal blocks	<a href="http://www.wago.com/281-419">www.wago.com/281-419</a>
<b>tools</b>		
	<b>Item no.: 210-720</b> Operating tool with partially insulated shaft; Type 2, blade (3.5 x 0.5) mm	<a href="http://www.wago.com/210-720">www.wago.com/210-720</a>
<b>Insulation stop</b>		
	<b>Item no.: 281-470</b> Insulation stop; 0.08 - 0.2 mm <sup>2</sup> "s" (0.14 mm <sup>2</sup> "f-st"); 5 pieces/strip	<a href="http://www.wago.com/281-470">www.wago.com/281-470</a>
	<b>Item no.: 281-471</b> Insulation stop; 0.25 - 0.5 mm <sup>2</sup> ; 5 pieces/strip	<a href="http://www.wago.com/281-471">www.wago.com/281-471</a>
	<b>Item no.: 281-472</b> Insulation stop; 0.75 - 1.5 mm <sup>2</sup> ; 5 pieces/strip	<a href="http://www.wago.com/281-472">www.wago.com/281-472</a>
<b>Jumper</b>		
	<b>Item no.: 249-123</b> Push-in type wire jumper; insulated; wire length 180 mm; Conductor cross section 0.75 mm <sup>2</sup>	<a href="http://www.wago.com/249-123">www.wago.com/249-123</a>
	<b>Item no.: 249-125</b> Push-in type wire jumper; insulated; wire length 60 mm; Conductor cross section 0.75 mm <sup>2</sup>	<a href="http://www.wago.com/249-125">www.wago.com/249-125</a>
	<b>Item no.: 249-126</b> Push-in type wire jumper; insulated; wire length 110 mm; Conductor cross section 0.75 mm <sup>2</sup>	<a href="http://www.wago.com/249-126">www.wago.com/249-126</a>

	<b>Item no.: 249-127</b> Push-in type wire jumper; insulated; wire length 250 mm; Conductor cross section 0.75 mm <sup>2</sup>	<a href="http://www.wago.com/249-127">www.wago.com/249-127</a>
	<b>Item no.: 281-402</b> Adjacent jumper; insulated; IN = IN terminal block	<a href="http://www.wago.com/281-402">www.wago.com/281-402</a>
	<b>Item no.: 281-409</b> Alternate jumper; insulated; IN = IN terminal block	<a href="http://www.wago.com/281-409">www.wago.com/281-409</a>
	<b>Item no.: 281-422</b> Adjacent jumper; insulated; IN = IN terminal block	<a href="http://www.wago.com/281-422">www.wago.com/281-422</a>
	<b>Item no.: 281-482</b> Comb-style jumper bar; insulated; 2-way; IN = IN terminal block	<a href="http://www.wago.com/281-482">www.wago.com/281-482</a>
	<b>Item no.: 281-483</b> Comb-style jumper bar; insulated; 3-way; IN = IN terminal block	<a href="http://www.wago.com/281-483">www.wago.com/281-483</a>
	<b>Item no.: 281-485</b> Comb-style jumper bar; insulated; 5-way; IN = IN terminal block	<a href="http://www.wago.com/281-485">www.wago.com/281-485</a>
	<b>Item no.: 281-490</b> Comb-style jumper bar; insulated; 10-way; IN = IN terminal block	<a href="http://www.wago.com/281-490">www.wago.com/281-490</a>
	<b>Item no.: 281-492</b> Alternate comb-style jumper bar; insulated; 2-way; IN = IN terminal block	<a href="http://www.wago.com/281-492">www.wago.com/281-492</a>
	<b>Item no.: 781-452</b> Staggered jumper; insulated; from 1 to 2; Spacing: 6 mm	<a href="http://www.wago.com/781-452">www.wago.com/781-452</a>
	<b>Item no.: 781-453</b> Staggered jumper; insulated; from 1 to 3; Spacing: 6 mm	<a href="http://www.wago.com/781-453">www.wago.com/781-453</a>
	<b>Item no.: 781-454</b> Staggered jumper; insulated; from 1 to 4; Spacing: 6 mm	<a href="http://www.wago.com/781-454">www.wago.com/781-454</a>
	<b>Item no.: 781-455</b> Staggered jumper; insulated; from 1 to 5; Spacing: 6 mm	<a href="http://www.wago.com/781-455">www.wago.com/781-455</a>
	<b>Item no.: 781-456</b> Staggered jumper; insulated; from 1 to 6; Spacing: 6 mm	<a href="http://www.wago.com/781-456">www.wago.com/781-456</a>















#### End plate

	<b>Item no.: 780-317</b> End and intermediate plate; 1.5 mm thick	<a href="http://www.wago.com/780-317">www.wago.com/780-317</a>
--	--	--

#### Marking accessories

	<b>Item no.: 2009-115</b> WMB-Inline; for smartPRINTER; on reel; stretchable 5 - 5.2 mm; plain; snap-on type	<a href="http://www.wago.com/2009-115">www.wago.com/2009-115</a>
	<b>Item no.: 2009-115/000-002</b> WMB-Inline; for smartPRINTER; on reel; stretchable 5 - 5.2 mm; plain; snap-on type	<a href="http://www.wago.com/2009-115/000-002">www.wago.com/2009-115/000-002</a>
	<b>Item no.: 2009-115/000-006</b> WMB-Inline; for smartPRINTER; on reel; stretchable 5 - 5.2 mm; plain; snap-on type	<a href="http://www.wago.com/2009-115/000-006">www.wago.com/2009-115/000-006</a>



	<b>Item no.: 2009-115/000-007</b> WMB-Inline; for smartPRINTER; on reel; stretchable 5 - 5.2 mm; plain; snap-on type	<a href="http://www.wago.com/2009-115/000-007">www.wago.com/2009-115/000-007</a>
	<b>Item no.: 2009-115/000-012</b> WMB-Inline; for smartPRINTER; on reel; stretchable 5 - 5.2 mm; plain; snap-on type	<a href="http://www.wago.com/2009-115/000-012">www.wago.com/2009-115/000-012</a>
	<b>Item no.: 2009-115/000-017</b> WMB-Inline; for smartPRINTER; on reel; stretchable 5 - 5.2 mm; plain; snap-on type	<a href="http://www.wago.com/2009-115/000-017">www.wago.com/2009-115/000-017</a>
	<b>Item no.: 2009-115/000-023</b> WMB-Inline; for smartPRINTER; on reel; stretchable 5 - 5.2 mm; plain; snap-on type	<a href="http://www.wago.com/2009-115/000-023">www.wago.com/2009-115/000-023</a>
	<b>Item no.: 2009-115/000-024</b> WMB-Inline; for smartPRINTER; on reel; stretchable 5 - 5.2 mm; plain; snap-on type	<a href="http://www.wago.com/2009-115/000-024">www.wago.com/2009-115/000-024</a>
	<b>Item no.: 209-185</b> Adaptor	<a href="http://www.wago.com/209-185">www.wago.com/209-185</a>
	<b>Item no.: 793-501</b> WMB marking card; as card; not stretchable; plain; snap-on type	<a href="http://www.wago.com/793-501">www.wago.com/793-501</a>
	<b>Item no.: 793-501/000-002</b> WMB marking card; as card; not stretchable; plain; snap-on type	<a href="http://www.wago.com/793-501/000-002">www.wago.com/793-501/000-002</a>
	<b>Item no.: 793-501/000-005</b> WMB marking card; as card; not stretchable; plain; snap-on type	<a href="http://www.wago.com/793-501/000-005">www.wago.com/793-501/000-005</a>
	<b>Item no.: 793-501/000-006</b> WMB marking card; as card; not stretchable; plain; snap-on type	<a href="http://www.wago.com/793-501/000-006">www.wago.com/793-501/000-006</a>
	<b>Item no.: 793-501/000-007</b> WMB marking card; as card; not stretchable; plain; snap-on type	<a href="http://www.wago.com/793-501/000-007">www.wago.com/793-501/000-007</a>
	<b>Item no.: 793-501/000-012</b> WMB marking card; as card; not stretchable; plain; snap-on type	<a href="http://www.wago.com/793-501/000-012">www.wago.com/793-501/000-012</a>
	<b>Item no.: 793-501/000-017</b> WMB marking card; as card; not stretchable; plain; snap-on type	<a href="http://www.wago.com/793-501/000-017">www.wago.com/793-501/000-017</a>
	<b>Item no.: 793-501/000-023</b> WMB marking card; as card; not stretchable; plain; snap-on type	<a href="http://www.wago.com/793-501/000-023">www.wago.com/793-501/000-023</a>
	<b>Item no.: 793-501/000-024</b> WMB marking card; as card; not stretchable; plain; snap-on type	<a href="http://www.wago.com/793-501/000-024">www.wago.com/793-501/000-024</a>



**Item no.: 793-5501**

WMB marking card; as card; for terminal block width 5 - 17.5 mm; stretchable 5 - 5.2 mm; plain; snap-on type [www.wago.com/793-5501](http://www.wago.com/793-5501)



**Item no.: 793-5501/000-002**

WMB marking card; as card; for terminal block width 5 - 17.5 mm; stretchable 5 - 5.2 mm; plain; snap-on type [www.wago.com/793-5501/000-002](http://www.wago.com/793-5501/000-002)



**Item no.: 793-5501/000-005**

WMB marking card; as card; stretchable 5 - 5.2 mm; plain; snap-on type [www.wago.com/793-5501/000-005](http://www.wago.com/793-5501/000-005)



**Item no.: 793-5501/000-006**

WMB marking card; as card; stretchable 5 - 5.2 mm; plain; snap-on type [www.wago.com/793-5501/000-006](http://www.wago.com/793-5501/000-006)



**Item no.: 793-5501/000-007**

WMB marking card; as card; stretchable 5 - 5.2 mm; plain; snap-on type [www.wago.com/793-5501/000-007](http://www.wago.com/793-5501/000-007)



**Item no.: 793-5501/000-012**

WMB marking card; as card; stretchable 5 - 5.2 mm; plain; snap-on type [www.wago.com/793-5501/000-012](http://www.wago.com/793-5501/000-012)



**Item no.: 793-5501/000-017**

WMB marking card; as card; stretchable 5 - 5.2 mm; plain; snap-on type [www.wago.com/793-5501/000-017](http://www.wago.com/793-5501/000-017)



**Item no.: 793-5501/000-023**

WMB marking card; as card; stretchable 5 - 5.2 mm; plain; snap-on type [www.wago.com/793-5501/000-023](http://www.wago.com/793-5501/000-023)



**Item no.: 793-5501/000-024**

WMB marking card; as card; stretchable 5 - 5.2 mm; plain; snap-on type [www.wago.com/793-5501/000-024](http://www.wago.com/793-5501/000-024)

**assembling**



**Item no.: 209-106**

Mounting carrier; for isolated mounting on DIN 35 rails [www.wago.com/209-106](http://www.wago.com/209-106)



**Item no.: 709-154**

Cover; Type 2; suitable for cover carrier, type 2; 1 m long [www.wago.com/709-154](http://www.wago.com/709-154)

**Downloads**

**Documentation**

**Bid Text**

781-631

Oct 19, 2017

DOC  
25.1 kB

Download



## smartDATA

### CAD data

3D Download 781-631

URL

Download

---

## Product family

**TOPJOB Classic**

[Show all products from the family](#)

Subject to changes.

---

WAGO Kontakttechnik GmbH & Co. KG

Hansastr. 27

32423 Minden

Phone: +49571 887-0 | Fax: +49571 887-169

Email: [info.de@wago.com](mailto:info.de@wago.com) | Web: [www.wago.com](http://www.wago.com)

Do you have any questions about our products?

We are always happy to take your call at +49 (571) 887-44222.