

Data sheet | Item number: 859-306

Relay module; Nominal input voltage: 60 VDC; 1 changeover contact; Red status indicator; Module width: 6 mm

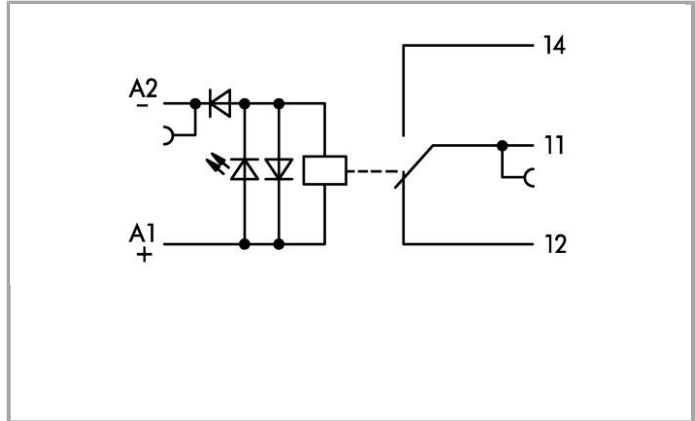

www.wago.com/859-306

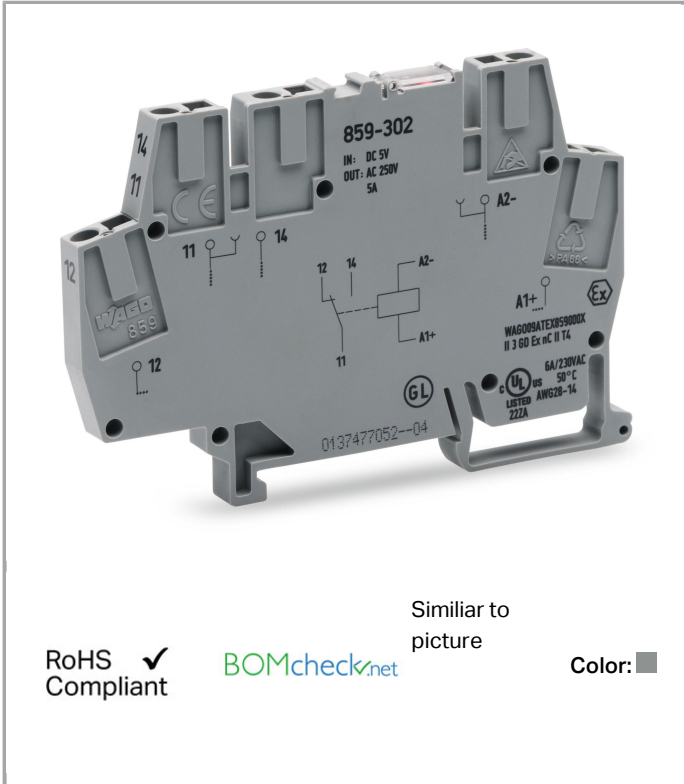

RoHS Compliant

BOMcheck.net

Similar to picture

Color: ■

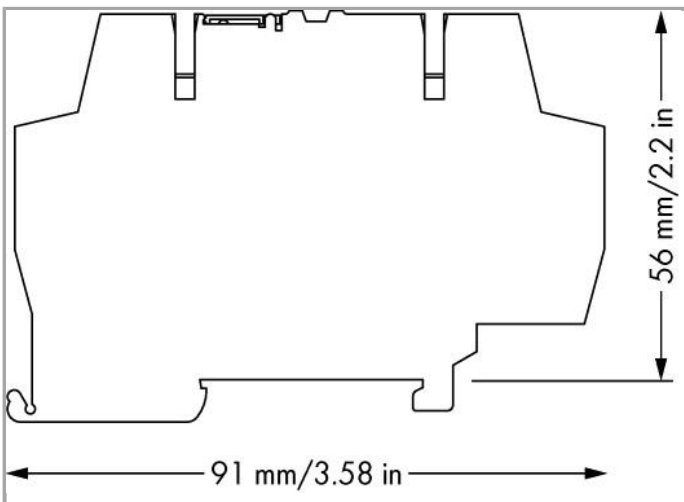

Item description

Note:

Inductive loads have to be attenuated by an appropriate protective circuit in order to protect relay coils and contacts.

Data

Technical Data

Control circuit

Nominal input voltage U_N	60 VDC
Input voltage range	-15 ... +20 %
Nominal input current at U_N	5.2 mA

Load circuit:

Number of changeover/switchover contacts	1
Contact material (relay)	AgSnO ₂
Limiting continuous current	5 A
Max. make current (resistive)	4 s 10 A (AC)
Max. switching voltage	250 VAC
Max. switching power (resistive)	1250 VAAC; DC see load limit curve
Recommended minimum load	10 V / 10 mA; 24 V / 1 mA
Pull-in time (typ.)	8 ms
Drop-out time (typ.)	4 ms
Bounce time (typ.)	5 ms
Electrical life (N.O.; resistive load; 23 °C)	50 x 10 ³ switching operations
Mechanical life (N.O.; resistive load; 23 °C)	5 x 10 ⁶ switching operations
Max. switching load with load/without load	6 min ⁻¹ / 180 min ⁻¹

Signaling

Status indication	LED red
-------------------	---------

Safety and protection:

Rated voltage	250 V
Rated impulse voltage	4 kV
Pollution degree	2
Dielectric strength, control/load circuit (AC, 1 min)	4 kV _{rms}
Dielectric strength, control/load circuit (AC, 1 min)	4 kV _{rms}
Dielectric strength open contact (AC, 1 min)	1 kV _{rms}
Dielectric strength open contact (AC, 1 min)	1 kV _{rms}



Connection data

Connection technology	CAGE CLAMP®
Solid conductor	0.08 ... 2.5 mm ² / 28 ... 14 AWG
Fine-stranded conductor	0.08 ... 2.5 mm ² / 28 ... 14 AWG
Strip length	5 ... 6 mm / 0.2 ... 0.24 Inch

Geometrical Data

Width	6 mm / 0.236 inch
Height from upper-edge of DIN-35 rail	56 mm / 2.205 inch
Depth	91 mm / 3.583 inch

Mechanical data

Type of mounting	DIN-35 rail
------------------	-------------

Material Data

Color	gray
Fire load	0.593 MJ
Weight	24.329 g

Environmental Requirements

Surrounding air (operating) temperature at U _N	-40 ... 50 °C
Surrounding air (storage) temperature	-40 ... 70 °C
Pollution degree	2

Standards and specifications

Standards/specifications	EN 61010-2-201; EN 61810-1; EN 61373; GL; UL 508
--------------------------	--

Commercial data

Country of origin	DE
GTIN	4055143602716
Customs Tariff No.	85364900990
Product Group	6 (Interface Electronics)

Approvals / Certificates

Ship Approvals

Logo	Approval	Certificate name
	DNV GL	TAA00001D1



Det Norske Veritas, Germanischer Lloyd

NK
Nippon Kaiji Kyokai

TA17255M

PRS
Polski Rejestr Statkow









TE/1989/880590/13















UL-Approvals

Logo	Approval	Certificate name
	UL UL International Netherlands B.V. (ORDINARY LOCATIONS)	E175199 Sec.4 (ORDINARY LOCATIONS)

Compatible products

Marking accessories

	Item no.: 2009-145 Mini-WSB Inline; for smartPRINTER; on reel; stretchable 5 - 5.2 mm; plain; snap-on type	www.wago.com/2009-145
	Item no.: 2009-145/000-002 Mini-WSB Inline; for smartPRINTER; on reel; stretchable 5 - 5.2 mm; plain; snap-on type	www.wago.com/2009-145/000-002
	Item no.: 2009-145/000-005 Mini-WSB Inline; for smartPRINTER; on reel; stretchable 5 - 5.2 mm; plain; snap-on type	www.wago.com/2009-145/000-005
	Item no.: 2009-145/000-006 Mini-WSB Inline; for smartPRINTER; on reel; stretchable 5 - 5.2 mm; plain; snap-on type	www.wago.com/2009-145/000-006
	Item no.: 2009-145/000-007 Mini-WSB Inline; for smartPRINTER; on reel; stretchable 5 - 5.2 mm; plain; snap-on type	www.wago.com/2009-145/000-007
	Item no.: 2009-145/000-012 Mini-WSB Inline; for smartPRINTER; on reel; stretchable 5 - 5.2 mm; plain; snap-on type	www.wago.com/2009-145/000-012
	Item no.: 2009-145/000-023 Mini-WSB Inline; for smartPRINTER; on reel; stretchable 5 - 5.2 mm; plain; snap-on type	www.wago.com/2009-145/000-023
	Item no.: 2009-145/000-024 Mini-WSB Inline; on reel; stretchable 5 - 5.2 mm; plain; snap-on type	www.wago.com/2009-145/000-024

	Item no.: 210-110 Fiber-tip pen	www.wago.com/210-110
	Item no.: 248-501 Miniature WSB Quick marking system; plain; Marker width 5 mm; 10 strips with 10 markers per card	www.wago.com/248-501
	Item no.: 248-501/000-002 Mini-WSB marking card; as card; not stretchable; plain; snap-on type	www.wago.com/248-501/000-002
	Item no.: 248-501/000-005 Mini-WSB marking card; as card; plain; snap-on type	www.wago.com/248-501/000-005
	Item no.: 248-501/000-006 Mini-WSB marking card; as card; not stretchable; plain; snap-on type	www.wago.com/248-501/000-006
	Item no.: 248-501/000-007 Mini-WSB marking card; as card; not stretchable; plain; snap-on type	www.wago.com/248-501/000-007
	Item no.: 248-501/000-012 Mini-WSB marking card; as card; not stretchable; plain; snap-on type	www.wago.com/248-501/000-012
	Item no.: 248-501/000-017 Mini-WSB marking card; as card; not stretchable; plain; snap-on type	www.wago.com/248-501/000-017
	Item no.: 248-501/000-023 Mini-WSB marking card; as card; not stretchable; plain; snap-on type	www.wago.com/248-501/000-023
	Item no.: 248-501/000-024 Mini-WSB marking card; as card; not stretchable; plain; snap-on type	www.wago.com/248-501/000-024
	Item no.: 248-502 Mini-WSB marking card; as card; MARKED; 1 ... 10 (10x); not stretchable; Horizontal marking; snap-on type	www.wago.com/248-502
	Item no.: 248-502/000-024 Mini-WSB marking card; as card; MARKED; 1 ... 10 (10x); not stretchable; Horizontal marking; snap-on type	www.wago.com/248-502/000-024
	Item no.: 248-503 Mini-WSB marking card; as card; MARKED; 11 ... 20 (10x); not stretchable; Horizontal marking; snap-on type	www.wago.com/248-503
	Item no.: 248-503/000-024 Mini-WSB marking card; as card; MARKED; 11 ... 20 (10x); not stretchable; Horizontal marking; snap-on type	www.wago.com/248-503/000-024
	Item no.: 248-504/000-024 Mini-WSB marking card; as card; MARKED; 21 ... 30 (10x); not stretchable; Horizontal marking; snap-on type	www.wago.com/248-504/000-024
	Item no.: 248-505/000-024	



Mini-WSB marking card; as card; MARKED; 31 ... 40 (10x); not stretchable; Horizontal marking; snap-on type

www.wago.com/248-505/000-024



Item no.: 248-506

Mini-WSB marking card; as card; MARKED; 41 ... 50 (10x); not stretchable; Horizontal marking; snap-on type

www.wago.com/248-506

check



Item no.: 859-500

Test pin; 1 mm Ø; with solder connection for test wire

www.wago.com/859-500

ferrule



Item no.: 216-221

Ferrule; Sleeve for 0.5 mm² / AWG 22; insulated; electro-tin plated

www.wago.com/216-221



Item no.: 216-222

Ferrule; Sleeve for 0.75 mm² / AWG 20; insulated; electro-tin plated

www.wago.com/216-222



Item no.: 216-223

Ferrule; Sleeve for 1 mm² / AWG 18; insulated; electro-tin plated

www.wago.com/216-223



Item no.: 216-224

Ferrule; Sleeve for 1.5 mm² / AWG 16; insulated; electro-tin plated

www.wago.com/216-224



Item no.: 216-321

Ferrule; Sleeve for 0.25 mm² / AWG 24; insulated; electro-tin plated

www.wago.com/216-321



Item no.: 216-322

Ferrule; Sleeve for 0.34 mm² / AWG 24; insulated; electro-tin plated

www.wago.com/216-322

tools



Item no.: 210-720

Operating tool with partially insulated shaft; Type 2, blade (3.5 x 0.5) mm

www.wago.com/210-720

End plate



Item no.: 859-525

End and intermediate plate; 1 mm thick

www.wago.com/859-525

Jumper



Item no.: 859-402

Push-in type jumper bar; 2-way; Nominal current 18 A; insulated

www.wago.com/859-402



Item no.: 859-402/000-005

Push-in type jumper bar; 2-way; Nominal current 18 A; insulated

















www.wago.com/859-402/000-005

















Item no.: 859-402/000-006

Push-in type jumper bar; 2-way; Nominal current 18 A; insulated

www.wago.com/859-402/000-006

	<p>Item no.: 859-402/000-029 Push-in type jumper bar; 2-way; Nominal current 18 A; insulated</p>	www.wago.com/859-402/000-029
	<p>Item no.: 859-403 Push-in type jumper bar; 3-way; Nominal current 18 A; insulated</p>	www.wago.com/859-403
	<p>Item no.: 859-403/000-005 Push-in type jumper bar; 3-way; Nominal current 18 A; insulated</p>	www.wago.com/859-403/000-005
	<p>Item no.: 859-403/000-006 Push-in type jumper bar; 3-way; Nominal current 18 A; insulated</p>	www.wago.com/859-403/000-006
	<p>Item no.: 859-403/000-029 Push-in type jumper bar; 3-way; Nominal current 18 A; insulated</p>	www.wago.com/859-403/000-029
	<p>Item no.: 859-404 Push-in type jumper bar; 4-way; Nominal current 18 A; insulated</p>	www.wago.com/859-404
	<p>Item no.: 859-404/000-005 Push-in type jumper bar; 4-way; Nominal current 18 A; insulated</p>	www.wago.com/859-404/000-005
	<p>Item no.: 859-404/000-006 Push-in type jumper bar; 4-way; Nominal current 18 A; insulated</p>	www.wago.com/859-404/000-006
	<p>Item no.: 859-404/000-029 Push-in type jumper bar; 4-way; Nominal current 18 A; insulated</p>	www.wago.com/859-404/000-029
	<p>Item no.: 859-405 Push-in type jumper bar; 5-way; Nominal current 18 A; insulated</p>	www.wago.com/859-405
	<p>Item no.: 859-405/000-005 Push-in type jumper bar; 5-way; Nominal current 18 A; insulated</p>	www.wago.com/859-405/000-005
	<p>Item no.: 859-405/000-006 Push-in type jumper bar; 5-way; Nominal current 18 A; insulated</p>	www.wago.com/859-405/000-006
	<p>Item no.: 859-405/000-029 Push-in type jumper bar; 5-way; Nominal current 18 A; insulated</p>	www.wago.com/859-405/000-029
	<p>Item no.: 859-406 Push-in type jumper bar; 6-way; Nominal current 18 A; insulated</p>	www.wago.com/859-406
	<p>Item no.: 859-406/000-005 Push-in type jumper bar; 6-way; Nominal current 18 A; insulated</p>	www.wago.com/859-406/000-005
	<p>Item no.: 859-406/000-006 Push-in type jumper bar; 6-way; Nominal current 18 A; insulated</p>	www.wago.com/859-406/000-006

	Item no.: 859-406/000-029 Push-in type jumper bar; 6-way; Nominal current 18 A; insulated	www.wago.com/859-406/000-029
	Item no.: 859-407 Push-in type jumper bar; 7-way; Nominal current 18 A; insulated	www.wago.com/859-407
	Item no.: 859-407/000-005 Push-in type jumper bar; 7-way; Nominal current 18 A; insulated	www.wago.com/859-407/000-005
	Item no.: 859-407/000-006 Push-in type jumper bar; 7-way; Nominal current 18 A; insulated	www.wago.com/859-407/000-006
	Item no.: 859-407/000-029 Push-in type jumper bar; 7-way; Nominal current 18 A; insulated	www.wago.com/859-407/000-029
	Item no.: 859-408 Push-in type jumper bar; 8-way; Nominal current 18 A; insulated	www.wago.com/859-408
	Item no.: 859-408/000-005 Push-in type jumper bar; 8-way; Nominal current 18 A; insulated	www.wago.com/859-408/000-005
	Item no.: 859-408/000-006 Push-in type jumper bar; 8-way; Nominal current 18 A; insulated	www.wago.com/859-408/000-006
	Item no.: 859-408/000-029 Push-in type jumper bar; 8-way; Nominal current 18 A; insulated	www.wago.com/859-408/000-029
	Item no.: 859-409 Push-in type jumper bar; 9-way; Nominal current 18 A; insulated	www.wago.com/859-409
	Item no.: 859-409/000-005 Push-in type jumper bar; 9-way; Nominal current 18 A; insulated	www.wago.com/859-409/000-005
	Item no.: 859-409/000-006 Push-in type jumper bar; 9-way; Nominal current 18 A; insulated	www.wago.com/859-409/000-006
	Item no.: 859-409/000-029 Push-in type jumper bar; 9-way; Nominal current 18 A; insulated	www.wago.com/859-409/000-029
	Item no.: 859-410 Push-in type jumper bar; 10-way; Nominal current 18 A; insulated	www.wago.com/859-410
	Item no.: 859-410/000-005 Push-in type jumper bar; 10-way; Nominal current 18 A; insulated	www.wago.com/859-410/000-005

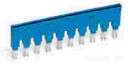

Item no.: 859-410/000-006
Push-in type jumper bar; 10-way; Nominal current 18 A; insulated

www.wago.com/859-410/000-006

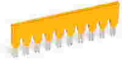

Item no.: 859-410/000-029
Push-in type jumper bar; 10-way; Nominal current 18 A; insulated

www.wago.com/859-410/000-029

Downloads

Documentation

Bid Text

859-306 Relaisbaustein	Jan 22, 2016	DOC 27.1 kB	Download
---------------------------	--------------	----------------	----------

Instruction Leaflet

Relay Modules, Optocoupler Modules, Specialty Functions	Dec 9, 2016	PDF 1.7 MB	Download
---	-------------	---------------	----------

Additional Information

Disposal; Electrical and electronic equipment, Packaging	Oct 15, 2018	265.8 kB	Download
--	--------------	----------	----------

smartDATA

CAD data

3D Download 859-306		URL	Download
---------------------	--	-----	----------

Subject to changes.