

Data sheet | Item number: 862-1525

4-conductor chassis-mount terminal strip; 1 snap-in foot at pos. 2+4; PE-N-L1-L2-L3; without ground contact; 5-pole

www.wago.com/862-1525



RoHS Compliant

[BOMcheck.net](https://www.bomcheck.net)

Color:

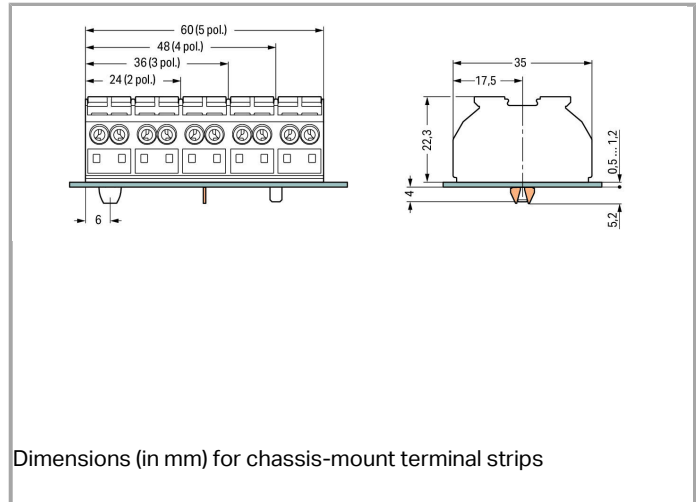

Dimensions (in mm) for chassis-mount terminal strips

Data

Electrical data

Ratings per IEC/EN 60664-1

Rated voltage (III / 3)	500 V
Rated impulse voltage (III / 3)	6 kV
Rated current	32 A
Legend (ratings)	(III / 3) $\hat{=}$ Overvoltage category III / Pollution degree 3

Connection data

Connection technology	Push-in CAGE CLAMP®
Actuation type	Operating tool Push-button
Connectable conductor materials	Copper Aluminum
Solid conductor	0.5 ... 4 mm ² / 20 ... 12 AWG
Solid conductor, push-in termination	0.75 ... 4 mm ² / 18 ... 12 AWG
Stranded conductor	0.5 ... 4 mm ² / 20 ... 12 AWG

Fine-stranded conductor	0.5 ... 4 mm ² / 20 ... 12 AWG
Fine-stranded conductor with ferrule with plastic collar	0.5 ... 2.5 mm ² / 20 ... 12 AWG
Fine-stranded conductor with ferrule, push-in termination, from	0.75 mm ² / 18 AWG
Strip length	10 ... 11 mm / 0.39 ... 0.43 Inch
No. of poles	5
Total number of connection points	20
Total number of potentials	5
Type of wiring	Side-entry wiring

Geometrical Data

Pin spacing	12 mm / 0.472 inch
Width	60 mm / 2.362 inch
Height from the surface	22.3 mm / 0.878 inch
Depth	35 mm / 1.378 inch

Mechanical data

Mounting type	Snap-in mounting foot
Marking	PE-N-L1-L2-L3

Material Data



Color	black
Fire load	0.643 MJ
Weight	34.164 g

Commercial data

Packaging type	bag
Country of origin	DE
GTIN	4044918509527
Customs Tariff No.	85369010000

Approvals / Certificates

Country specific Approvals

Logo	Approval	Certificate name
	CCA DEKRA Certification B.V.	NTR NL 6912
	CCA DEKRA Certification B.V.	2146425.01



CSA
DEKRA Certification B.V.

1505030



ENEC 15
UL International Germany GmbH

143856-01

Ship Approvals

Logo	Approval	Certificate name
	LR Lloyds Register	91/20112 (E9)

UL-Approvals



Logo	Approval	Certificate name
	UL UL International Germany GmbH	E45172 sec. 39

Compatible products

tools

	Item no.: 210-720 Operating tool with partially insulated shaft; Type 2, blade (3.5 x 0.5) mm	www.wago.com/210-720
--	---	--

Marking accessories

	Item no.: 709-177 Marking strips; on reel; 7.5 mm wide; not stretchable; plain; snap-on type	www.wago.com/709-177
	Item no.: 709-178 Marking strips; on reel; 7.5 mm wide; not stretchable; plain; snap-on type	www.wago.com/709-178

check

	Item no.: 210-136 Test plug; 2 mm Ø; with 500 mm cable	www.wago.com/210-136
	Item no.: 210-137 Test plug; 2.3 mm Ø; with 500 mm cable	www.wago.com/210-137

Jumper

	Item no.: 862-482 Comb-style jumper bar; for conductor entry; insulated; terminated conductor entry	www.wago.com/862-482
--	---	--

ferrule



	Item no.: 216-141 Ferrule; Sleeve for 0.5 mm ² / AWG 22; uninsulated; electro-tin plated; electrolytic copper; gastight crimped; acc. to DIN 46228, Part 1/08.92	www.wago.com/216-141
	Item no.: 216-142 Ferrule; Sleeve for 0.75 mm ² / AWG 20; uninsulated; electro-tin plated; electrolytic copper; gastight crimped; acc. to DIN 46228, Part 1/08.92	www.wago.com/216-142
	Item no.: 216-143 Ferrule; Sleeve for 1 mm ² / AWG 18; uninsulated; electro-tin plated; electrolytic copper; gastight crimped; acc. to DIN 46228, Part 1/08.92	www.wago.com/216-143
	Item no.: 216-144 Ferrule; Sleeve for 1.5 mm ² / AWG 16; uninsulated; electro-tin plated; electrolytic copper; gastight crimped; acc. to DIN 46228, Part 1/08.92	www.wago.com/216-144
	Item no.: 216-241 Ferrule; Sleeve for 0.5 mm ² / AWG 22; insulated; electro-tin plated; electrolytic copper; gastight crimped; acc. to DIN 46228, Part 4/09.90	www.wago.com/216-241
	Item no.: 216-242 Ferrule; Sleeve for 0.75 mm ² / AWG 20; insulated; electro-tin plated; electrolytic copper; gastight crimped; acc. to DIN 46228, Part 4/09.90	www.wago.com/216-242
	Item no.: 216-243 Ferrule; Sleeve for 1 mm ² / AWG 18; insulated; electro-tin plated; electrolytic copper; gastight crimped; acc. to DIN 46228, Part 4/09.90	www.wago.com/216-243
	Item no.: 216-244 Ferrule; Sleeve for 1.5 mm ² / AWG 16; insulated; electro-tin plated; electrolytic copper; gastight crimped; acc. to DIN 46228, Part 4/09.90	www.wago.com/216-244

Downloads

Documentation

Bid Text

862-1525	Oct 19, 2017	DOC 25.6 kB	Download
----------	--------------	----------------	----------

smartDATA

CAD data

3D Download 862-1525	URL	Download
----------------------	-----	----------

Subject to changes.

WAGO Kontakttechnik GmbH & Co. KG
 Hansastr. 27
 32423 Minden
 Phone: +49571 887-0 | Fax: +49571 887-169
 Email: info.de@wago.com | Web: www.wago.com

Do you have any questions about our products?
 We are always happy to take your call at +49 (571) 887-44222.