

Data sheet | Item number: 862-1632/999-950

4-conductor Ex e II chassis-mount terminal strip; 1 snap-in foot per pole; L1-N; suitable for Ex e II applications; 2-pole

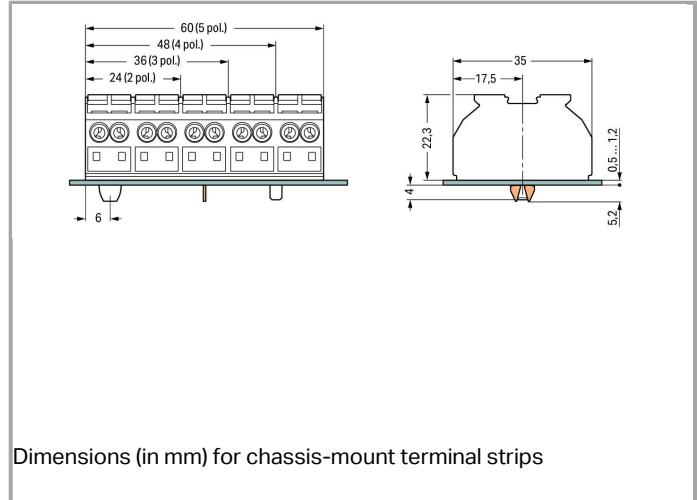

www.wago.com/862-1632/999-950



Data

Electrical data

Rated voltage EN (Ex e II) 440 V

Ratings per IEC/EN 60664-1

Rated current 28 A

Connection data

Connection technology Push-in CAGE CLAMP®

Actuation type Operating tool

Connectable conductor materials Copper
Aluminum

Solid conductor 0.5 ... 4 mm² / 20 ... 12 AWG

Solid conductor, push-in termination 0.75 ... 4 mm² / 18 ... 12 AWG

Stranded conductor	0.5 ... 4 mm ² / 20 ... 12 AWG
Fine-stranded conductor	0.5 ... 4 mm ² / 20 ... 12 AWG
Fine-stranded conductor with ferrule with plastic collar	0.5 ... 2.5 mm ² / 20 ... 12 AWG
Fine-stranded conductor with ferrule, push-in termination, from	0.75 mm ² / 18 AWG
Strip length	10 ... 11 mm / 0.39 ... 0.43 Inch
No. of poles	2
Total number of connection points	8
Total number of potentials	2
Type of wiring	Side-entry wiring

Geometrical Data

Pin spacing	12 mm / 0.472 inch
Width	24 mm / 0.945 inch
Height from the surface	22.3 mm / 0.878 inch
Depth	35 mm / 1.378 inch

Mechanical data

Mounting type	Snap-in mounting foot
Marking	L1-N

Material Data



Color	white
Fire load	0.271 MJ
Weight	14.238 g

Commercial data

Packaging type	bag
Country of origin	DE
GTIN	4045454803537
Customs Tariff No.	85369010000

Approvals / Certificates

Ex-Approvals

Logo	Approval	Certificate name
	ATEX Physikalisch Technische Bundesanstalt (PTB)	PTB 03 ATEX 1189 U (II 2 G Ex e II)
	IECEx Physikalisch Technische Bundesanstalt	IECEx PTB 05.0003 U

Country specific Approvals

Logo	Approval	Certificate name
	CSA DEKRA Certification B.V.	1505030

Ship Approvals

Logo	Approval	Certificate name
	LR Lloyds Register	91/20112 (E9)

Compatible products

tools

	Item no.: 210-720 Operating tool with partially insulated shaft; Type 2, blade (3.5 x 0.5) mm	www.wago.com/210-720
--	--	--



Jumper

	Item no.: 862-482 Comb-style jumper bar; for conductor entry; insulated; terminated conductor entry	www.wago.com/862-482
--	--	--



check







	Item no.: 210-136 Test plug; 2 mm Ø; with 500 mm cable	www.wago.com/210-136
	Item no.: 210-137 Test plug; 2.3 mm Ø; with 500 mm cable	www.wago.com/210-137

Marking accessories

	Item no.: 709-177 Marking strips; on reel; 7.5 mm wide; not stretchable; plain; snap-on type	www.wago.com/709-177
	Item no.: 709-178 Marking strips; on reel; 7.5 mm wide; not stretchable; plain; snap-on type	www.wago.com/709-178

ferrule

	Item no.: 216-141 Ferrule; Sleeve for 0.5 mm ² / AWG 22; uninsulated; electro-tin plated; electrolytic copper; gastight crimped; acc. to DIN 46228, Part 1/08.92	www.wago.com/216-141
	Item no.: 216-142 Ferrule; Sleeve for 0.75 mm ² / AWG 20; uninsulated; electro-tin plated; electrolytic copper; gastight crimped; acc. to DIN 46228, Part 1/08.92	www.wago.com/216-142
	Item no.: 216-143 Ferrule; Sleeve for 1 mm ² / AWG 18; uninsulated; electro-tin plated; electrolytic copper; gastight	www.wago.com/216-143

	crimped; acc. to DIN 46228, Part 1/08.92	
	Item no.: 216-144 Ferrule; Sleeve for 1.5 mm ² / AWG 16; uninsulated; electro-tin plated; electrolytic copper; gastight crimped; acc. to DIN 46228, Part 1/08.92	www.wago.com/216-144
	Item no.: 216-241 Ferrule; Sleeve for 0.5 mm ² / AWG 22; insulated; electro-tin plated; electrolytic copper; gastight crimped; acc. to DIN 46228, Part 4/09.90	www.wago.com/216-241
	Item no.: 216-242 Ferrule; Sleeve for 0.75 mm ² / AWG 20; insulated; electro-tin plated; electrolytic copper; gastight crimped; acc. to DIN 46228, Part 4/09.90	www.wago.com/216-242
	Item no.: 216-243 Ferrule; Sleeve for 1 mm ² / AWG 18; insulated; electro-tin plated; electrolytic copper; gastight crimped; acc. to DIN 46228, Part 4/09.90	www.wago.com/216-243
	Item no.: 216-244 Ferrule; Sleeve for 1.5 mm ² / AWG 16; insulated; electro-tin plated; electrolytic copper; gastight crimped; acc. to DIN 46228, Part 4/09.90	www.wago.com/216-244

Downloads

Documentation

Bid Text

862-1632/999-950	Oct 19, 2017	DOC 25.1 kB	Download
------------------	--------------	----------------	----------

smartDATA

CAD data

3D Download 862-1632/999-950	URL	Download
------------------------------	-----	----------

Subject to changes.