

Data sheet | Item number: 862-652

4-conductor chassis-mount terminal strip; for mounting via M3 screw and nut or self-tapping screw 2.9 mm Ø from top; plain; with 2x pin; 2-pole



[www.wago.com/862-652](http://www.wago.com/862-652)



RoHS  Compliant

[BOMcheck.net](http://BOMcheck.net)

Color:

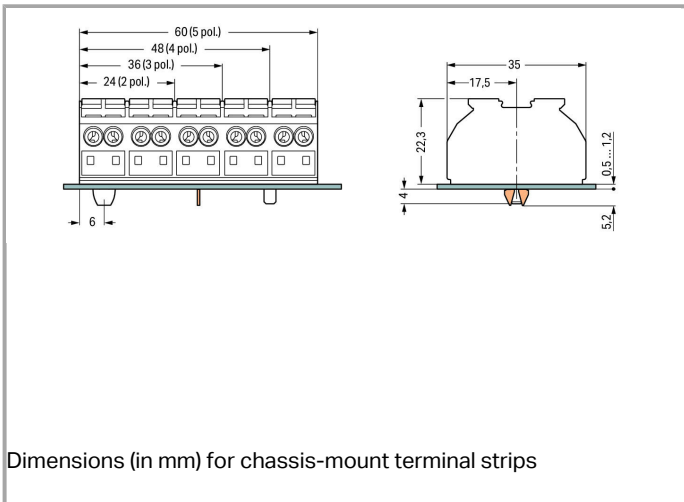

Data  
Electrical data



### Ratings per IEC/EN 60664-1

Rated voltage (III / 3)	500 V
Rated impulse voltage (III / 3)	6 kV
Rated current	32 A
Legend (ratings)	(III / 3) $\hat{=}$ Overvoltage category III / Pollution degree 3

### Connection data

Connection technology	Push-in CAGE CLAMP®
Actuation type	Operating tool Push-button
Connectable conductor materials	Copper Aluminum
Solid conductor	0.5 ... 4 mm <sup>2</sup> / 20 ... 12 AWG
Solid conductor, push-in termination	0.75 ... 4 mm <sup>2</sup> / 18 ... 12 AWG
Stranded conductor	0.5 ... 4 mm <sup>2</sup> / 20 ... 12 AWG
Fine-stranded conductor	0.5 ... 4 mm <sup>2</sup> / 20 ... 12 AWG
Fine-stranded conductor with ferrule with plastic collar	0.5 ... 2.5 mm <sup>2</sup> / 20 ... 12 AWG
Fine-stranded conductor with ferrule, push-in termination, from	0.75 mm <sup>2</sup> / 18 AWG
Strip length	10 ... 11 mm / 0.39 ... 0.43 Inch
No. of poles	2
Total number of connection points	8
Total number of potentials	2
Type of wiring	Side-entry wiring

### Geometrical Data

Pin spacing	12 mm / 0.472 inch
Width	24 mm / 0.945 inch
Height from the surface	22.3 mm / 0.878 inch
Depth	35 mm / 1.378 inch

### Mechanical data

Mounting type	Screw mounting
Marking	plain

### Material Data





Color	white
Fire load	0.266 MJ
Weight	13.5 g

## Commercial data

Packaging type	bag
Country of origin	DE
GTIN	4044918509411
Customs Tariff No.	85369010000

## Approvals / Certificates

### Country specific Approvals

Logo	Approval	Certificate name
	CCA DEKRA Certification B.V.	2146425.01
	CCA DEKRA Certification B.V.	NTR NL 6912
	CSA DEKRA Certification B.V.	1505030
	ENEC 15 UL International Germany GmbH	143856-01

### Ship Approvals

Logo	Approval	Certificate name
	LR Lloyds Register	91/20112 (E9)

### UL-Approvals

Logo	Approval	Certificate name
	UL UL International Germany GmbH	E45172 sec. 39

## Compatible products

### Jumper

Item no.: 862-482



Comb-style jumper bar; for conductor entry; insulated; terminated conductor entry

[www.wago.com/862-482](http://www.wago.com/862-482)

## ferrule

	<b>Item no.: 216-141</b> Ferrule; Sleeve for 0.5 mm <sup>2</sup> / AWG 22; uninsulated; electro-tin plated; electrolytic copper; gastight crimped; acc. to DIN 46228, Part 1/08.92	<a href="http://www.wago.com/216-141">www.wago.com/216-141</a>
	<b>Item no.: 216-142</b> Ferrule; Sleeve for 0.75 mm <sup>2</sup> / AWG 20; uninsulated; electro-tin plated; electrolytic copper; gastight crimped; acc. to DIN 46228, Part 1/08.92	<a href="http://www.wago.com/216-142">www.wago.com/216-142</a>
	<b>Item no.: 216-143</b> Ferrule; Sleeve for 1 mm <sup>2</sup> / AWG 18; uninsulated; electro-tin plated; electrolytic copper; gastight crimped; acc. to DIN 46228, Part 1/08.92	<a href="http://www.wago.com/216-143">www.wago.com/216-143</a>
	<b>Item no.: 216-144</b> Ferrule; Sleeve for 1.5 mm <sup>2</sup> / AWG 16; uninsulated; electro-tin plated; electrolytic copper; gastight crimped; acc. to DIN 46228, Part 1/08.92	<a href="http://www.wago.com/216-144">www.wago.com/216-144</a>
	<b>Item no.: 216-241</b> Ferrule; Sleeve for 0.5 mm <sup>2</sup> / AWG 22; insulated; electro-tin plated; electrolytic copper; gastight crimped; acc. to DIN 46228, Part 4/09.90	<a href="http://www.wago.com/216-241">www.wago.com/216-241</a>
	<b>Item no.: 216-242</b> Ferrule; Sleeve for 0.75 mm <sup>2</sup> / AWG 20; insulated; electro-tin plated; electrolytic copper; gastight crimped; acc. to DIN 46228, Part 4/09.90	<a href="http://www.wago.com/216-242">www.wago.com/216-242</a>
	<b>Item no.: 216-243</b> Ferrule; Sleeve for 1 mm <sup>2</sup> / AWG 18; insulated; electro-tin plated; electrolytic copper; gastight crimped; acc. to DIN 46228, Part 4/09.90	<a href="http://www.wago.com/216-243">www.wago.com/216-243</a>
	<b>Item no.: 216-244</b> Ferrule; Sleeve for 1.5 mm <sup>2</sup> / AWG 16; insulated; electro-tin plated; electrolytic copper; gastight crimped; acc. to DIN 46228, Part 4/09.90	<a href="http://www.wago.com/216-244">www.wago.com/216-244</a>



## check

	<b>Item no.: 210-136</b> Test plug; 2 mm Ø; with 500 mm cable	<a href="http://www.wago.com/210-136">www.wago.com/210-136</a>
	<b>Item no.: 210-137</b> Test plug; 2.3 mm Ø; with 500 mm cable	<a href="http://www.wago.com/210-137">www.wago.com/210-137</a>

## tools

	<b>Item no.: 210-720</b> Operating tool with partially insulated shaft; Type 2, blade (3.5 x 0.5) mm	<a href="http://www.wago.com/210-720">www.wago.com/210-720</a>
------------------------------------------------------------------------------------	---------------------------------------------------------------------------------------------------------	----------------------------------------------------------------

## Marking accessories

	<b>Item no.: 709-177</b> Marking strips; on reel; 7.5 mm wide; not stretchable; plain; snap-on type	<a href="http://www.wago.com/709-177">www.wago.com/709-177</a>
	<b>Item no.: 709-178</b> Marking strips; on reel; 7.5 mm wide; not stretchable; plain; snap-on type	<a href="http://www.wago.com/709-178">www.wago.com/709-178</a>



Downloads

Documentation

Bid Text

---

862-652	Oct 19, 2017	DOC 25.1 kB	Download
---------	--------------	----------------	----------

---

smartDATA

CAD data

---

3D Download 862-652	URL	Download
---------------------	-----	----------

---

Subject to changes.