

Data sheet | Item number: 870-527

Double-deck terminal block; Ground conductor/through terminal block; PE/L; without marker carrier; Blue conductor entry upper deck; for DIN-rail 35 x 15 and 35 x 7.5; 2.5 mm²; CAGE CLAMP®

www.wago.com/870-527

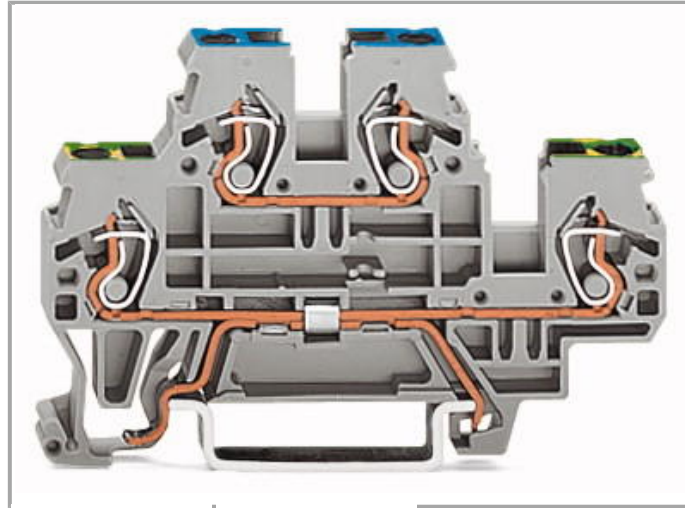

RoHS
Compliant ✓

BOMcheck.net

Color: ■

Data

Electrical data

Ratings per IEC/EN 60664-1

Rated voltage (III / 3)	500 V
Rated impulse voltage (III / 3)	6 kV
Rated current	24 A
Legend (ratings)	(III / 3) ± Overvoltage category III / Pollution degree 3

Connection data

Connection technology	CAGE CLAMP®
Actuation type	Operating tool
Connectable conductor materials	Copper Aluminum
Solid conductor	0.08 ... 2.5 mm ² / 28 ... 12 AWG
Fine-stranded conductor	0.08 ... 4 mm ² / 28 ... 12 AWG
Strip length	6 ... 7 mm / 0.24 ... 0.28 Inch
Total number of connection points	4
Total number of potentials	2

Number of levels	2
Type of wiring	Front-entry wiring

Geometrical Data

Width	5 mm / 0.197 inch
Height from upper-edge of DIN-35 rail	40 mm / 1.575 inch
Depth	70 mm / 2.756 inch

Mechanical data

Design	horizontal
Type of mounting	DIN-35 rail
Potential marking	PE/L
Marking level	Side marking

Material Data



Color	gray
Fire load	0.164 MJ
Weight	11.31 g

Commercial data

Country of origin	DE
GTIN	4044918649711
Customs Tariff No.	85369010000

Approvals / Certificates

Country specific Approvals

Logo	Approval	Certificate name
	CCA DEKRA Certification B.V.	NTR NL 7468
	CCA DEKRA Certification B.V.	2189801.01

Ship Approvals

Logo	Approval	Certificate name
	ABS American Bureau of Shipping	14-HG1293677-PDA



BV
Bureau Veritas S.A.

07436/E0 BV



LR
Lloyds Register

91/20112 (E9)









UL-Approvals















Logo	Approval	Certificate name
	cURus UL International Germany GmbH	E45172



















Compatible products

Marking accessories

	Item no.: 2009-115 WMB-Inline; for smartPRINTER; on reel; stretchable 5 - 5.2 mm; plain; snap-on type	www.wago.com/2009-115
	Item no.: 2009-115/000-002 WMB-Inline; for smartPRINTER; on reel; stretchable 5 - 5.2 mm; plain; snap-on type	www.wago.com/2009-115/000-002
	Item no.: 2009-115/000-006 WMB-Inline; for smartPRINTER; on reel; stretchable 5 - 5.2 mm; plain; snap-on type	www.wago.com/2009-115/000-006
	Item no.: 2009-115/000-007 WMB-Inline; for smartPRINTER; on reel; stretchable 5 - 5.2 mm; plain; snap-on type	www.wago.com/2009-115/000-007
	Item no.: 2009-115/000-012 WMB-Inline; for smartPRINTER; on reel; stretchable 5 - 5.2 mm; plain; snap-on type	www.wago.com/2009-115/000-012
	Item no.: 2009-115/000-017 WMB-Inline; for smartPRINTER; on reel; stretchable 5 - 5.2 mm; plain; snap-on type	www.wago.com/2009-115/000-017
	Item no.: 2009-115/000-023 WMB-Inline; for smartPRINTER; on reel; stretchable 5 - 5.2 mm; plain; snap-on type	www.wago.com/2009-115/000-023
	Item no.: 2009-115/000-024 WMB-Inline; for smartPRINTER; on reel; stretchable 5 - 5.2 mm; plain; snap-on type	www.wago.com/2009-115/000-024
	Item no.: 2009-145 Mini-WSB Inline; for smartPRINTER; on reel; stretchable 5 - 5.2 mm; plain; snap-on type	www.wago.com/2009-145

	<p>Item no.: 2009-145/000-002 Mini-WSB Inline; for smartPRINTER; on reel; stretchable 5 - 5.2 mm; plain; snap-on type</p>	<p>www.wago.com/2009-145/000-002</p>
	<p>Item no.: 2009-145/000-005 Mini-WSB Inline; for smartPRINTER; on reel; stretchable 5 - 5.2 mm; plain; snap-on type</p>	<p>www.wago.com/2009-145/000-005</p>
	<p>Item no.: 2009-145/000-006 Mini-WSB Inline; for smartPRINTER; on reel; stretchable 5 - 5.2 mm; plain; snap-on type</p>	<p>www.wago.com/2009-145/000-006</p>
	<p>Item no.: 2009-145/000-007 Mini-WSB Inline; for smartPRINTER; on reel; stretchable 5 - 5.2 mm; plain; snap-on type</p>	<p>www.wago.com/2009-145/000-007</p>
	<p>Item no.: 2009-145/000-012 Mini-WSB Inline; for smartPRINTER; on reel; stretchable 5 - 5.2 mm; plain; snap-on type</p>	<p>www.wago.com/2009-145/000-012</p>
	<p>Item no.: 2009-145/000-023 Mini-WSB Inline; for smartPRINTER; on reel; stretchable 5 - 5.2 mm; plain; snap-on type</p>	<p>www.wago.com/2009-145/000-023</p>
	<p>Item no.: 2009-145/000-024 Mini-WSB Inline; on reel; stretchable 5 - 5.2 mm; plain; snap-on type</p>	<p>www.wago.com/2009-145/000-024</p>
	<p>Item no.: 248-501 Miniature WSB Quick marking system; plain; Marker width 5 mm; 10 strips with 10 markers per card</p>	<p>www.wago.com/248-501</p>
	<p>Item no.: 248-501/000-002 Mini-WSB marking card; as card; not stretchable; plain; snap-on type</p>	<p>www.wago.com/248-501/000-002</p>
	<p>Item no.: 248-501/000-005 Mini-WSB marking card; as card; plain; snap-on type</p>	<p>www.wago.com/248-501/000-005</p>
	<p>Item no.: 248-501/000-006 Mini-WSB marking card; as card; not stretchable; plain; snap-on type</p>	<p>www.wago.com/248-501/000-006</p>
	<p>Item no.: 248-501/000-007 Mini-WSB marking card; as card; not stretchable; plain; snap-on type</p>	<p>www.wago.com/248-501/000-007</p>
	<p>Item no.: 248-501/000-012 Mini-WSB marking card; as card; not stretchable; plain; snap-on type</p>	<p>www.wago.com/248-501/000-012</p>
	<p>Item no.: 248-501/000-017 Mini-WSB marking card; as card; not stretchable; plain; snap-on type</p>	<p>www.wago.com/248-501/000-017</p>
	<p>Item no.: 248-501/000-023 Mini-WSB marking card; as card; not stretchable; plain; snap-on type</p>	<p>www.wago.com/248-501/000-023</p>

	Item no.: 248-501/000-024 Mini-WSB marking card; as card; not stretchable; plain; snap-on type	www.wago.com/248-501/000-024
	Item no.: 709-177 Marking strips; on reel; 7.5 mm wide; not stretchable; plain; snap-on type	www.wago.com/709-177
	Item no.: 709-178 Marking strips; on reel; 7.5 mm wide; not stretchable; plain; snap-on type	www.wago.com/709-178
	Item no.: 709-196 Marking strips; for laser printer	www.wago.com/709-196
	Item no.: 793-501 WMB marking card; as card; not stretchable; plain; snap-on type	www.wago.com/793-501
	Item no.: 793-501/000-002 WMB marking card; as card; not stretchable; plain; snap-on type	www.wago.com/793-501/000-002
	Item no.: 793-501/000-005 WMB marking card; as card; not stretchable; plain; snap-on type	www.wago.com/793-501/000-005
	Item no.: 793-501/000-006 WMB marking card; as card; not stretchable; plain; snap-on type	www.wago.com/793-501/000-006
	Item no.: 793-501/000-007 WMB marking card; as card; not stretchable; plain; snap-on type	www.wago.com/793-501/000-007
	Item no.: 793-501/000-012 WMB marking card; as card; not stretchable; plain; snap-on type	www.wago.com/793-501/000-012
	Item no.: 793-501/000-017 WMB marking card; as card; not stretchable; plain; snap-on type	www.wago.com/793-501/000-017
	Item no.: 793-501/000-023 WMB marking card; as card; not stretchable; plain; snap-on type	www.wago.com/793-501/000-023
	Item no.: 793-501/000-024 WMB marking card; as card; not stretchable; plain; snap-on type	www.wago.com/793-501/000-024
	Item no.: 793-5501 WMB marking card; as card; for terminal block width 5 - 17.5 mm; stretchable 5 - 5.2 mm; plain; snap-on type	www.wago.com/793-5501
	Item no.: 793-5501/000-002 WMB marking card; as card; for terminal block width 5 - 17.5 mm; stretchable 5 - 5.2 mm; plain; snap-on type	www.wago.com/793-5501/000-002
	Item no.: 793-5501/000-005 WMB marking card; as card; stretchable 5 - 5.2 mm; plain; snap-on type	www.wago.com/793-5501/000-005



Item no.: 793-5501/000-006
WMB marking card; as card; stretchable 5 - 5.2 mm; plain; snap-on type

www.wago.com/793-5501/000-006



Item no.: 793-5501/000-007
WMB marking card; as card; stretchable 5 - 5.2 mm; plain; snap-on type

www.wago.com/793-5501/000-007



Item no.: 793-5501/000-012
WMB marking card; as card; stretchable 5 - 5.2 mm; plain; snap-on type

www.wago.com/793-5501/000-012



Item no.: 793-5501/000-017
WMB marking card; as card; stretchable 5 - 5.2 mm; plain; snap-on type

www.wago.com/793-5501/000-017



Item no.: 793-5501/000-023
WMB marking card; as card; stretchable 5 - 5.2 mm; plain; snap-on type

www.wago.com/793-5501/000-023



Item no.: 793-5501/000-024
WMB marking card; as card; stretchable 5 - 5.2 mm; plain; snap-on type

www.wago.com/793-5501/000-024

Protective Warning Marker



Item no.: 280-405
Protective warning marker; with high-voltage symbol, black; for 5 terminal blocks

www.wago.com/280-405

ferrule



Item no.: 216-121
Ferrule; Sleeve for 0.5 mm² / AWG 22; uninsulated; electro-tin plated

www.wago.com/216-121



Item no.: 216-122
Ferrule; Sleeve for 0.75 mm² / AWG 20; uninsulated; electro-tin plated

www.wago.com/216-122



Item no.: 216-123
Ferrule; Sleeve for 1 mm² / AWG 18; uninsulated; electro-tin plated

www.wago.com/216-123



Item no.: 216-124
Ferrule; Sleeve for 1.5 mm² / AWG 16; uninsulated; electro-tin plated

www.wago.com/216-124



Item no.: 216-131
Ferrule; Sleeve for 0.25 mm² / AWG 24; uninsulated; electro-tin plated

www.wago.com/216-131



Item no.: 216-132
Ferrule; Sleeve for 0.34 mm² / AWG 24; uninsulated; electro-tin plated

www.wago.com/216-132



Item no.: 216-221
Ferrule; Sleeve for 0.5 mm² / AWG 22; insulated; electro-tin plated

www.wago.com/216-221



Item no.: 216-222
Ferrule; Sleeve for 0.75 mm² / AWG 20; insulated; electro-tin plated



















www.wago.com/216-222



















Item no.: 216-223
Ferrule; Sleeve for 1 mm² / AWG 18; insulated; electro-tin plated

www.wago.com/216-223

Item no.: 216-224

	Ferrule; Sleeve for 1.5 mm ² / AWG 16; insulated; electro-tin plated	www.wago.com/216-224
	Item no.: 216-321 Ferrule; Sleeve for 0.25 mm ² / AWG 24; insulated; electro-tin plated	www.wago.com/216-321
	Item no.: 216-322 Ferrule; Sleeve for 0.34 mm ² / AWG 24; insulated; electro-tin plated	www.wago.com/216-322
Insulation stop		
	Item no.: 280-470 Insulation stop; 0.08 - 0.2 mm ² "s" (0.14 mm ² "f-st"); 5 pieces/strip	www.wago.com/280-470
	Item no.: 280-471 Insulation stop; 0.25 - 0.5 mm ² ; 5 pieces/strip	www.wago.com/280-471
	Item no.: 280-472 Insulation stop; 0.75 - 1 mm ² ; 5 pieces/strip	www.wago.com/280-472
Jumper		
	Item no.: 709-110 Wire commoning chain; insulated; 4 connections; 3 x 110 mm	www.wago.com/709-110
	Item no.: 709-111 Wire commoning chain; insulated; 3 connections; 2 x 120 mm	www.wago.com/709-111
	Item no.: 709-112 Wire commoning chain; insulated; 3 connections; 2 x 170 mm	www.wago.com/709-112
	Item no.: 870-402 Push-in type jumper bar; insulated; 2-way; Nominal current 18 A	www.wago.com/870-402
	Item no.: 870-403 Push-in type jumper bar; insulated; 3-way; Nominal current 18 A	www.wago.com/870-403
	Item no.: 870-404 Push-in type jumper bar; insulated; 4-way; Nominal current 18 A	www.wago.com/870-404
	Item no.: 870-405 Push-in type jumper bar; insulated; 5-way; Nominal current 18 A	www.wago.com/870-405
	Item no.: 870-405/011-000 Ready-made push-in type jumper bar; insulated; 3-way (1-3-5); Nominal current 18 A	www.wago.com/870-405/011-000
	Item no.: 870-406 Push-in type jumper bar; insulated; 6-way; Nominal current 18 A	www.wago.com/870-406
	Item no.: 870-407 Push-in type jumper bar; insulated; 7-way; Nominal current 18 A	www.wago.com/870-407
	Item no.: 870-407/011-000 Ready-made push-in type jumper bar; insulated; 3-way (1-3-5); Nominal current 18 A	www.wago.com/870-407/011-000
	Item no.: 870-408 Push-in type jumper bar; insulated; 8-way; Nominal current 18 A	www.wago.com/870-408

	Item no.: 870-409 Push-in type jumper bar; insulated; 9-way; Nominal current 18 A	www.wago.com/870-409
	Item no.: 870-409/011-000 Ready-made push-in type jumper bar; insulated; 3-way (1-3-5); Nominal current 18 A	www.wago.com/870-409/011-000
	Item no.: 870-410 Push-in type jumper bar; insulated; 10-way; Nominal current 18 A	www.wago.com/870-410
	Item no.: 870-433 Push-in type jumper bar; insulated; from 1 to 3; Nominal current 18 A	www.wago.com/870-433
	Item no.: 870-434 Push-in type jumper bar; insulated; from 1 to 4; Nominal current 18 A	www.wago.com/870-434
	Item no.: 870-435 Push-in type jumper bar; insulated; from 1 to 5; Nominal current 18 A	www.wago.com/870-435
	Item no.: 870-436 Push-in type jumper bar; insulated; from 1 to 6; Nominal current 18 A	www.wago.com/870-436
	Item no.: 870-437 Push-in type jumper bar; insulated; from 1 to 7; Nominal current 18 A	www.wago.com/870-437
	Item no.: 870-438 Push-in type jumper bar; insulated; from 1 to 8; Nominal current 18 A	www.wago.com/870-438
	Item no.: 870-439 Push-in type jumper bar; insulated; from 1 to 9; Nominal current 18 A	www.wago.com/870-439
	Item no.: 870-440 Push-in type jumper bar; insulated; from 1 to 10; Nominal current 18 A	www.wago.com/870-440
End plate		
	Item no.: 870-518 End and intermediate plate; 2 mm thick	www.wago.com/870-518
	Item no.: 870-519 End and intermediate plate; 2 mm thick	www.wago.com/870-519
assembling		
	Item no.: 209-106 Mounting carrier; for isolated mounting on DIN 35 rails	www.wago.com/209-106
	Item no.: 249-116 Screwless end stop; 6 mm wide	www.wago.com/249-116
	Item no.: 249-117 Screwless end stop; 10 mm wide	www.wago.com/249-117
tools		
	Item no.: 210-657 Operating tool with partially insulated shaft; Blade (3.5 x 0.5) mm; short	www.wago.com/210-657



Item no.: 210-658
Operating tool with partially insulated shaft; Blade (3.5 x 0.5) mm; short; angled

www.wago.com/210-658



Item no.: 210-720
Operating tool with partially insulated shaft; Type 2, blade (3.5 x 0.5) mm

www.wago.com/210-720

General accessories



Item no.: 870-182
Adaptor

www.wago.com/870-182



Item no.: 870-183
Adaptor

www.wago.com/870-183



Item no.: 870-184
Adaptor

www.wago.com/870-184



Item no.: 870-425
Tap-off module; with anti-rotation protection; modular; suitable for 870 Series terminal blocks with jumper slots in the current bar

www.wago.com/870-425



Item no.: 870-426
Tap-off module; modular; suitable for 870 Series terminal blocks with jumper slots in the current bar

www.wago.com/870-426



Item no.: 870-427
Spacer module; modular; bridging commoned terminal blocks

www.wago.com/870-427

Carrier rail



Item no.: 210-112
Steel carrier rail; 35 x 7.5 mm; 1 mm thick; 2 m long; slotted; according to EN 60715; "Hole width 25 mm

www.wago.com/210-112

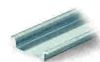

Item no.: 210-113
Steel carrier rail; 35 x 7.5 mm; 1 mm thick; 2 m long; unslotted; according to EN 60715

www.wago.com/210-113



Item no.: 210-114
Steel carrier rail; 35 x 15 mm; 1.5 mm thick; 2 m long; unslotted; similar to EN 60715

www.wago.com/210-114



Item no.: 210-115
Steel carrier rail; 35 x 7.5 mm; 1 mm thick; 2 m long; slotted; according to EN 60715; "Hole width 18 mm

www.wago.com/210-115



Item no.: 210-118
Steel carrier rail; 35 x 15 mm; 2.3 mm thick; 2 m long; unslotted; according to EN 60715

www.wago.com/210-118



Item no.: 210-196
Aluminum carrier rail; 35 x 8.2 mm; 1.6 mm thick; 2 m long; unslotted; similar to EN 60715

www.wago.com/210-196



Item no.: 210-197
Steel carrier rail; 35 x 15 mm; 1.5 mm thick; 2 m long; slotted; similar to EN 60715

www.wago.com/210-197



Item no.: 210-504
Steel carrier rail; 35 x 7.5 mm; 1 mm thick; 2 m long; slotted; galvanized; according to EN 60715

www.wago.com/210-504

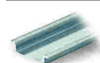

Item no.: 210-505
Steel carrier rail; 35 x 7.5 mm; 1 mm thick; 2 m long; unslotted; galvanized; according to EN 60715

www.wago.com/210-505



Item no.: 210-506
Steel carrier rail; 35 x 15 mm; 1.5 mm thick; 2 m long; unslotted; galvanized; similar to EN 60715

www.wago.com/210-506



Item no.: 210-508

Steel carrier rail; 35 x 15 mm; 1.5 mm thick; 2 m long; slotted; galvanized; similar to EN 60715

www.wago.com/210-508

Downloads

Documentation

Bid Text

870-527	Oct 20, 2017	DOC 25.1 kB	Download
---------	--------------	----------------	----------

smartDATA

CAD data

3D Download 870-527	URL	Download
---------------------	-----	----------

Subject to changes.