

Data sheet | Item number: 870-551

Triple-deck terminal block; Through/through/through terminal block; L/L/L;
for DIN-rail 35 x 15 and 35 x 7.5; 2.5 mm²; CAGE CLAMP®

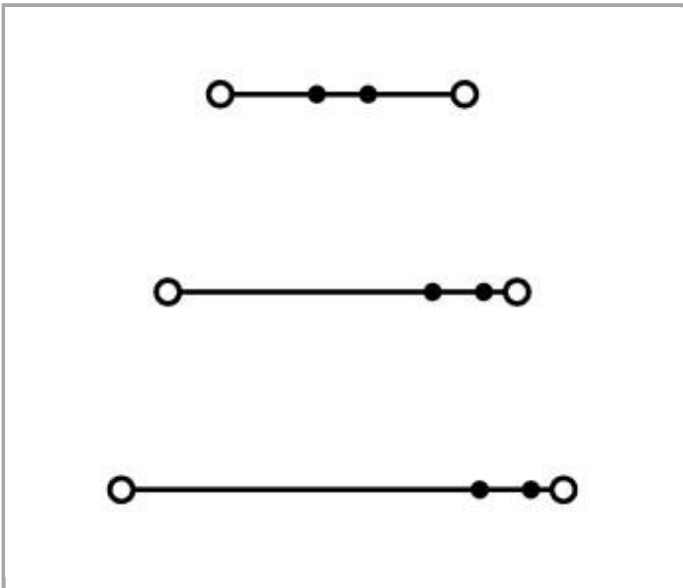

www.wago.com/870-551

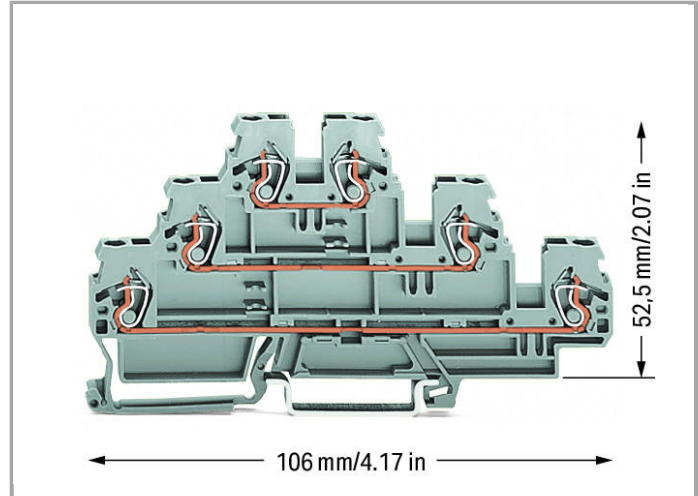
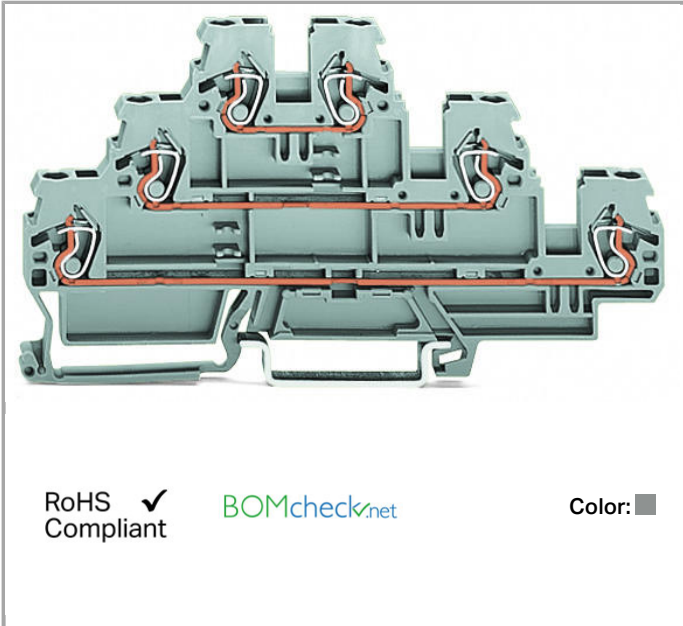

Data

Electrical data

Ratings per IEC/EN 60664-1

Rated voltage (III / 3)	500 V
Rated impulse voltage (III / 3)	6 kV



Rated current	24 A
Legend (ratings)	(III / 3) $\hat{=}$ Overvoltage category III / Pollution degree 3

Connection data

Connection technology	CAGE CLAMP®
Actuation type	Operating tool
Connectable conductor materials	Copper Aluminum
Solid conductor	0.08 ... 2.5 mm ² / 28 ... 12 AWG
Fine-stranded conductor	0.08 ... 4 mm ² / 28 ... 12 AWG
Strip length	6 ... 7 mm / 0.24 ... 0.28 Inch
Total number of connection points	6
Total number of potentials	3
Number of levels	3
Type of wiring	Front-entry wiring

Geometrical Data

Width	5 mm / 0.197 inch
Height from upper-edge of DIN-35 rail	52.5 mm / 2.067 inch
Depth	106 mm / 4.173 inch

Mechanical data

Design	horizontal
Type of mounting	DIN-35 rail
Potential marking	L/L/L
Marking level	Side marking

Material Data

Color	gray
Fire load	0.278 MJ
Weight	17.352 g

Commercial data

Country of origin	DE
GTIN	4045454129019
Customs Tariff No.	85369010000

Approvals / Certificates

Country specific Approvals

Logo	Approval	Certificate name

CCA	CCA DEKRA Certification B.V.	NTR NL 7468
	CCA DEKRA Certification B.V.	2189801.01

Ship Approvals





Logo	Approval	Certificate name
ABS	ABS American Bureau of Shipping	14-HG1293677-PDA
BV	BV Bureau Veritas S.A.	07436/E0 BV
	LR Lloyds Register	91/20112 (E9)

UL-Approvals

Logo	Approval	Certificate name
	cURus UL International Germany GmbH	E45172

Compatible products

General accessories

	Item no.: 870-182 Adaptor	www.wago.com/870-182
	Item no.: 870-183 Adaptor	www.wago.com/870-183
	Item no.: 870-184 Adaptor	www.wago.com/870-184
	Item no.: 870-425 Tap-off module; with anti-rotation protection; modular; suitable for 870 Series terminal blocks with jumper slots in the current bar	www.wago.com/870-425
	Item no.: 870-426 Tap-off module; modular; suitable for 870 Series terminal blocks with jumper slots in the current bar	www.wago.com/870-426



Item no.: 870-427
Spacer module; modular; bridging commoned terminal blocks

www.wago.com/870-427

Insulation stop



Item no.: 280-470
Insulation stop; 0.08 - 0.2 mm² "s" (0.14 mm² "f-st"); 5 pieces/strip

www.wago.com/280-470



Item no.: 280-471
Insulation stop; 0.25 - 0.5 mm²; 5 pieces/strip

www.wago.com/280-471



Item no.: 280-472
Insulation stop; 0.75 - 1 mm²; 5 pieces/strip

www.wago.com/280-472

End plate



Item no.: 870-568
End and intermediate plate; 2 mm thick

www.wago.com/870-568



Item no.: 870-569
End and intermediate plate; 2 mm thick

www.wago.com/870-569

Carrier rail



Item no.: 210-112
Steel carrier rail; 35 x 7.5 mm; 1 mm thick; 2 m long; slotted; according to EN 60715; "Hole width 25 mm

www.wago.com/210-112



Item no.: 210-113
Steel carrier rail; 35 x 7.5 mm; 1 mm thick; 2 m long; unslotted; according to EN 60715

www.wago.com/210-113



Item no.: 210-114
Steel carrier rail; 35 x 15 mm; 1.5 mm thick; 2 m long; unslotted; similar to EN 60715

www.wago.com/210-114



Item no.: 210-115
Steel carrier rail; 35 x 7.5 mm; 1 mm thick; 2 m long; slotted; according to EN 60715; "Hole width 18 mm

www.wago.com/210-115



Item no.: 210-118
Steel carrier rail; 35 x 15 mm; 2.3 mm thick; 2 m long; unslotted; according to EN 60715

www.wago.com/210-118



Item no.: 210-196
Aluminum carrier rail; 35 x 8.2 mm; 1.6 mm thick; 2 m long; unslotted; similar to EN 60715

www.wago.com/210-196



Item no.: 210-197
Steel carrier rail; 35 x 15 mm; 1.5 mm thick; 2 m long; slotted; similar to EN 60715

www.wago.com/210-197



Item no.: 210-504
Steel carrier rail; 35 x 7.5 mm; 1 mm thick; 2 m long; slotted; galvanized; according to EN 60715

www.wago.com/210-504



Item no.: 210-505
Steel carrier rail; 35 x 7.5 mm; 1 mm thick; 2 m long; unslotted; galvanized; according to EN 60715

www.wago.com/210-505



Item no.: 210-506
Steel carrier rail; 35 x 15 mm; 1.5 mm thick; 2 m long; unslotted; galvanized; similar to EN 60715













www.wago.com/210-506









Item no.: 210-508
Steel carrier rail; 35 x 15 mm; 1.5 mm thick; 2 m long; slotted; galvanized; similar to EN 60715















www.wago.com/210-508

ferrule

	Item no.: 216-121 Ferrule; Sleeve for 0.5 mm ² / AWG 22; uninsulated; electro-tin plated	www.wago.com/216-121
	Item no.: 216-122 Ferrule; Sleeve for 0.75 mm ² / AWG 20; uninsulated; electro-tin plated	www.wago.com/216-122
	Item no.: 216-123 Ferrule; Sleeve for 1 mm ² / AWG 18; uninsulated; electro-tin plated	www.wago.com/216-123
	Item no.: 216-124 Ferrule; Sleeve for 1.5 mm ² / AWG 16; uninsulated; electro-tin plated	www.wago.com/216-124
	Item no.: 216-131 Ferrule; Sleeve for 0.25 mm ² / AWG 24; uninsulated; electro-tin plated	www.wago.com/216-131
	Item no.: 216-132 Ferrule; Sleeve for 0.34 mm ² / AWG 24; uninsulated; electro-tin plated	www.wago.com/216-132
	Item no.: 216-221 Ferrule; Sleeve for 0.5 mm ² / AWG 22; insulated; electro-tin plated	www.wago.com/216-221
	Item no.: 216-222 Ferrule; Sleeve for 0.75 mm ² / AWG 20; insulated; electro-tin plated	www.wago.com/216-222
	Item no.: 216-223 Ferrule; Sleeve for 1 mm ² / AWG 18; insulated; electro-tin plated	www.wago.com/216-223
	Item no.: 216-224 Ferrule; Sleeve for 1.5 mm ² / AWG 16; insulated; electro-tin plated	www.wago.com/216-224
	Item no.: 216-321 Ferrule; Sleeve for 0.25 mm ² / AWG 24; insulated; electro-tin plated	www.wago.com/216-321
	Item no.: 216-322 Ferrule; Sleeve for 0.34 mm ² / AWG 24; insulated; electro-tin plated	www.wago.com/216-322

Jumper

	Item no.: 709-110 Wire commoning chain; insulated; 4 connections; 3 x 110 mm	www.wago.com/709-110
	Item no.: 709-111 Wire commoning chain; insulated; 3 connections; 2 x 120 mm	www.wago.com/709-111
	Item no.: 709-112 Wire commoning chain; insulated; 3 connections; 2 x 170 mm	www.wago.com/709-112
	Item no.: 870-402 Push-in type jumper bar; insulated; 2-way; Nominal current 18 A	www.wago.com/870-402
	Item no.: 870-403 Push-in type jumper bar; insulated; 3-way; Nominal current 18 A	www.wago.com/870-403
	Item no.: 870-404 Push-in type jumper bar; insulated; 4-way; Nominal current 18 A	www.wago.com/870-404
	Item no.: 870-405 Push-in type jumper bar; insulated; 5-way; Nominal current 18 A	www.wago.com/870-405

	<p>Item no.: 870-405/011-000 Ready-made push-in type jumper bar; insulated; 3-way (1-3-5); Nominal current 18 A</p>	www.wago.com/870-405/011-000
	<p>Item no.: 870-406 Push-in type jumper bar; insulated; 6-way; Nominal current 18 A</p>	www.wago.com/870-406
	<p>Item no.: 870-407 Push-in type jumper bar; insulated; 7-way; Nominal current 18 A</p>	www.wago.com/870-407
	<p>Item no.: 870-407/011-000 Ready-made push-in type jumper bar; insulated; 3-way (1-3-5); Nominal current 18 A</p>	www.wago.com/870-407/011-000
	<p>Item no.: 870-408 Push-in type jumper bar; insulated; 8-way; Nominal current 18 A</p>	www.wago.com/870-408
	<p>Item no.: 870-409 Push-in type jumper bar; insulated; 9-way; Nominal current 18 A</p>	www.wago.com/870-409
	<p>Item no.: 870-409/011-000 Ready-made push-in type jumper bar; insulated; 3-way (1-3-5); Nominal current 18 A</p>	www.wago.com/870-409/011-000
	<p>Item no.: 870-410 Push-in type jumper bar; insulated; 10-way; Nominal current 18 A</p>	www.wago.com/870-410
	<p>Item no.: 870-433 Push-in type jumper bar; insulated; from 1 to 3; Nominal current 18 A</p>	www.wago.com/870-433
	<p>Item no.: 870-434 Push-in type jumper bar; insulated; from 1 to 4; Nominal current 18 A</p>	www.wago.com/870-434
	<p>Item no.: 870-435 Push-in type jumper bar; insulated; from 1 to 5; Nominal current 18 A</p>	www.wago.com/870-435
	<p>Item no.: 870-436 Push-in type jumper bar; insulated; from 1 to 6; Nominal current 18 A</p>	www.wago.com/870-436
	<p>Item no.: 870-437 Push-in type jumper bar; insulated; from 1 to 7; Nominal current 18 A</p>	www.wago.com/870-437
	<p>Item no.: 870-438 Push-in type jumper bar; insulated; from 1 to 8; Nominal current 18 A</p>	www.wago.com/870-438
	<p>Item no.: 870-439 Push-in type jumper bar; insulated; from 1 to 9; Nominal current 18 A</p>	www.wago.com/870-439
	<p>Item no.: 870-440 Push-in type jumper bar; insulated; from 1 to 10; Nominal current 18 A</p>	www.wago.com/870-440

Protective Warning Marker

	<p>Item no.: 280-405 Protective warning marker; with high-voltage symbol, black; for 5 terminal blocks</p>	www.wago.com/280-405
--	--	--

assembling



Item no.: 209-106
Mounting carrier; for isolated mounting on DIN 35 rails

www.wago.com/209-106



Item no.: 249-116
Screwless end stop; 6 mm wide

www.wago.com/249-116



Item no.: 249-117
Screwless end stop; 10 mm wide

www.wago.com/249-117

Marking accessories



Item no.: 2009-115
WMB-Inline; for smartPRINTER; on reel; stretchable 5 - 5.2 mm; plain; snap-on type

www.wago.com/2009-115



Item no.: 2009-115/000-002
WMB-Inline; for smartPRINTER; on reel; stretchable 5 - 5.2 mm; plain; snap-on type

www.wago.com/2009-115/000-002



Item no.: 2009-115/000-006
WMB-Inline; for smartPRINTER; on reel; stretchable 5 - 5.2 mm; plain; snap-on type

www.wago.com/2009-115/000-006



Item no.: 2009-115/000-007
WMB-Inline; for smartPRINTER; on reel; stretchable 5 - 5.2 mm; plain; snap-on type

www.wago.com/2009-115/000-007



Item no.: 2009-115/000-012
WMB-Inline; for smartPRINTER; on reel; stretchable 5 - 5.2 mm; plain; snap-on type

www.wago.com/2009-115/000-012



Item no.: 2009-115/000-017
WMB-Inline; for smartPRINTER; on reel; stretchable 5 - 5.2 mm; plain; snap-on type

www.wago.com/2009-115/000-017



Item no.: 2009-115/000-023
WMB-Inline; for smartPRINTER; on reel; stretchable 5 - 5.2 mm; plain; snap-on type

www.wago.com/2009-115/000-023



Item no.: 2009-115/000-024
WMB-Inline; for smartPRINTER; on reel; stretchable 5 - 5.2 mm; plain; snap-on type

www.wago.com/2009-115/000-024



Item no.: 2009-145
Mini-WSB Inline; for smartPRINTER; on reel; stretchable 5 - 5.2 mm; plain; snap-on type

www.wago.com/2009-145



Item no.: 2009-145/000-002
Mini-WSB Inline; for smartPRINTER; on reel; stretchable 5 - 5.2 mm; plain; snap-on type

www.wago.com/2009-145/000-002

















Item no.: 2009-145/000-005
Mini-WSB Inline; for smartPRINTER; on reel; stretchable 5 - 5.2 mm; plain; snap-on type















www.wago.com/2009-145/000-005



Item no.: 2009-145/000-006
Mini-WSB Inline; for smartPRINTER; on reel; stretchable 5 - 5.2 mm; plain; snap-on type

www.wago.com/2009-145/000-006

	<p>Item no.: 2009-145/000-007 Mini-WSB Inline; for smartPRINTER; on reel; stretchable 5 - 5.2 mm; plain; snap-on type</p>	www.wago.com/2009-145/000-007
	<p>Item no.: 2009-145/000-012 Mini-WSB Inline; for smartPRINTER; on reel; stretchable 5 - 5.2 mm; plain; snap-on type</p>	www.wago.com/2009-145/000-012
	<p>Item no.: 2009-145/000-023 Mini-WSB Inline; for smartPRINTER; on reel; stretchable 5 - 5.2 mm; plain; snap-on type</p>	www.wago.com/2009-145/000-023
	<p>Item no.: 2009-145/000-024 Mini-WSB Inline; on reel; stretchable 5 - 5.2 mm; plain; snap-on type</p>	www.wago.com/2009-145/000-024
	<p>Item no.: 248-501 Miniature WSB Quick marking system; plain; Marker width 5 mm; 10 strips with 10 markers per card</p>	www.wago.com/248-501
	<p>Item no.: 248-501/000-002 Mini-WSB marking card; as card; not stretchable; plain; snap-on type</p>	www.wago.com/248-501/000-002
	<p>Item no.: 248-501/000-005 Mini-WSB marking card; as card; plain; snap-on type</p>	www.wago.com/248-501/000-005
	<p>Item no.: 248-501/000-006 Mini-WSB marking card; as card; not stretchable; plain; snap-on type</p>	www.wago.com/248-501/000-006
	<p>Item no.: 248-501/000-007 Mini-WSB marking card; as card; not stretchable; plain; snap-on type</p>	www.wago.com/248-501/000-007
	<p>Item no.: 248-501/000-012 Mini-WSB marking card; as card; not stretchable; plain; snap-on type</p>	www.wago.com/248-501/000-012
	<p>Item no.: 248-501/000-017 Mini-WSB marking card; as card; not stretchable; plain; snap-on type</p>	www.wago.com/248-501/000-017
	<p>Item no.: 248-501/000-023 Mini-WSB marking card; as card; not stretchable; plain; snap-on type</p>	www.wago.com/248-501/000-023
	<p>Item no.: 248-501/000-024 Mini-WSB marking card; as card; not stretchable; plain; snap-on type</p>	www.wago.com/248-501/000-024
	<p>Item no.: 709-177 Marking strips; on reel; 7.5 mm wide; not stretchable; plain; snap-on type</p>	www.wago.com/709-177
	<p>Item no.: 709-178 Marking strips; on reel; 7.5 mm wide; not stretchable; plain; snap-on type</p>	www.wago.com/709-178

	<p>Item no.: 709-196 Marking strips; for laser printer</p>	www.wago.com/709-196
	<p>Item no.: 793-501 WMB marking card; as card; not stretchable; plain; snap-on type</p>	www.wago.com/793-501
	<p>Item no.: 793-501/000-002 WMB marking card; as card; not stretchable; plain; snap-on type</p>	www.wago.com/793-501/000-002
	<p>Item no.: 793-501/000-005 WMB marking card; as card; not stretchable; plain; snap-on type</p>	www.wago.com/793-501/000-005
	<p>Item no.: 793-501/000-006 WMB marking card; as card; not stretchable; plain; snap-on type</p>	www.wago.com/793-501/000-006
	<p>Item no.: 793-501/000-007 WMB marking card; as card; not stretchable; plain; snap-on type</p>	www.wago.com/793-501/000-007
	<p>Item no.: 793-501/000-012 WMB marking card; as card; not stretchable; plain; snap-on type</p>	www.wago.com/793-501/000-012
	<p>Item no.: 793-501/000-017 WMB marking card; as card; not stretchable; plain; snap-on type</p>	www.wago.com/793-501/000-017
	<p>Item no.: 793-501/000-023 WMB marking card; as card; not stretchable; plain; snap-on type</p>	www.wago.com/793-501/000-023
	<p>Item no.: 793-501/000-024 WMB marking card; as card; not stretchable; plain; snap-on type</p>	www.wago.com/793-501/000-024
	<p>Item no.: 793-5501 WMB marking card; as card; for terminal block width 5 - 17.5 mm; stretchable 5 - 5.2 mm; plain; snap-on type</p>	www.wago.com/793-5501
	<p>Item no.: 793-5501/000-002 WMB marking card; as card; for terminal block width 5 - 17.5 mm; stretchable 5 - 5.2 mm; plain; snap-on type</p>	www.wago.com/793-5501/000-002
	<p>Item no.: 793-5501/000-005 WMB marking card; as card; stretchable 5 - 5.2 mm; plain; snap-on type</p>	www.wago.com/793-5501/000-005
	<p>Item no.: 793-5501/000-006 WMB marking card; as card; stretchable 5 - 5.2 mm; plain; snap-on type</p>	www.wago.com/793-5501/000-006
	<p>Item no.: 793-5501/000-007 WMB marking card; as card; stretchable 5 - 5.2 mm; plain; snap-on type</p>	www.wago.com/793-5501/000-007



Item no.: 793-5501/000-012
WMB marking card; as card; stretchable 5 - 5.2 mm; plain; snap-on type

www.wago.com/793-5501/000-012



Item no.: 793-5501/000-017
WMB marking card; as card; stretchable 5 - 5.2 mm; plain; snap-on type

www.wago.com/793-5501/000-017



Item no.: 793-5501/000-023
WMB marking card; as card; stretchable 5 - 5.2 mm; plain; snap-on type

www.wago.com/793-5501/000-023



Item no.: 793-5501/000-024
WMB marking card; as card; stretchable 5 - 5.2 mm; plain; snap-on type

www.wago.com/793-5501/000-024

tools



Item no.: 210-657
Operating tool with partially insulated shaft; Blade (3.5 x 0.5) mm; short

www.wago.com/210-657



Item no.: 210-658
Operating tool with partially insulated shaft; Blade (3.5 x 0.5) mm; short; angled

www.wago.com/210-658



Item no.: 210-720
Operating tool with partially insulated shaft; Type 2, blade (3.5 x 0.5) mm

www.wago.com/210-720

Downloads

Documentation

Bid Text

870-551	Oct 20, 2017	DOC 25.1 kB	Download
---------	--------------	----------------	----------

smartDATA

CAD data

3D Download 870-551	URL	Download
---------------------	-----	----------

Subject to changes.