

Data sheet | Item number: 870-567

Triple-deck terminal block; Ground conductor/through/through terminal block; PE/N/L; without marker carrier; for DIN-rail 35 x 15 and 35 x 7.5; 2.5 mm²; CAGE CLAMP®

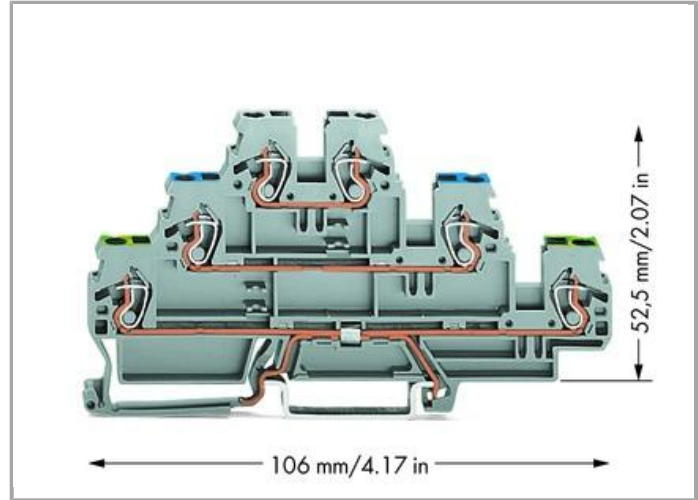

www.wago.com/870-567

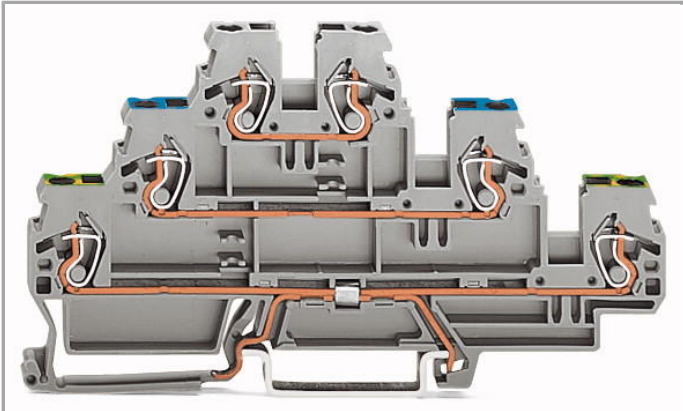

RoHS Compliant

[BOMcheck.net](https://www.bomcheck.net)

Color: ■

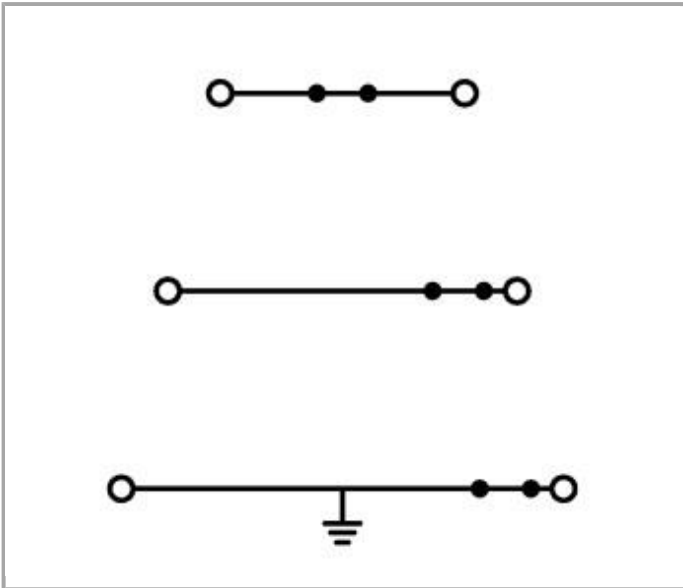

Data

Electrical data

Ratings per IEC/EN 60664-1

Rated voltage (III / 3)	500 V
Rated impulse voltage (III / 3)	6 kV



Rated current	24 A
Legend (ratings)	(III / 3) $\hat{=}$ Overvoltage category III / Pollution degree 3

Connection data

Connection technology	CAGE CLAMP®
Actuation type	Operating tool
Connectable conductor materials	Copper Aluminum
Solid conductor	0.08 ... 2.5 mm ² / 28 ... 12 AWG
Fine-stranded conductor	0.08 ... 4 mm ² / 28 ... 12 AWG
Strip length	6 ... 7 mm / 0.24 ... 0.28 Inch
Total number of connection points	6
Total number of potentials	3
Number of levels	3
Type of wiring	Front-entry wiring

Geometrical Data

Width	5 mm / 0.197 inch
Height from upper-edge of DIN-35 rail	52.5 mm / 2.067 inch
Depth	106 mm / 4.173 inch

Mechanical data

Design	horizontal
Type of mounting	DIN-35 rail
Potential marking	PE/N/L
Marking level	Side marking

Material Data

Color	gray
Fire load	0.275 MJ
Weight	18.995 g

Commercial data

Country of origin	DE
GTIN	4045454129095
Customs Tariff No.	85369010000

Approvals / Certificates

Country specific Approvals

Logo	Approval	Certificate name

CCA	CCA DEKRA Certification B.V.	NTR NL 7468
	CCA DEKRA Certification B.V.	2189801.01

Ship Approvals





Logo	Approval	Certificate name
ABS	ABS American Bureau of Shipping	14-HG1293677-PDA
BV	BV Bureau Veritas S.A.	07436/E0 BV
	LR Lloyds Register	91/20112 (E9)

UL-Approvals

Logo	Approval	Certificate name
	cURus UL International Germany GmbH	E45172

Compatible products

General accessories

	Item no.: 870-182 Adaptor	www.wago.com/870-182
	Item no.: 870-183 Adaptor	www.wago.com/870-183
	Item no.: 870-184 Adaptor	www.wago.com/870-184
	Item no.: 870-425 Tap-off module; with anti-rotation protection; modular; suitable for 870 Series terminal blocks with jumper slots in the current bar	www.wago.com/870-425
	Item no.: 870-426 Tap-off module; modular; suitable for 870 Series terminal blocks with jumper slots in the current bar	www.wago.com/870-426



Item no.: 870-427
Spacer module; modular; bridging commoned terminal blocks

www.wago.com/870-427

Jumper



Item no.: 709-110
Wire commoning chain; insulated; 4 connections; 3 x 110 mm

www.wago.com/709-110



Item no.: 709-111
Wire commoning chain; insulated; 3 connections; 2 x 120 mm

www.wago.com/709-111



Item no.: 709-112
Wire commoning chain; insulated; 3 connections; 2 x 170 mm

www.wago.com/709-112



Item no.: 870-402
Push-in type jumper bar; insulated; 2-way; Nominal current 18 A

www.wago.com/870-402



Item no.: 870-403
Push-in type jumper bar; insulated; 3-way; Nominal current 18 A

www.wago.com/870-403



Item no.: 870-404
Push-in type jumper bar; insulated; 4-way; Nominal current 18 A

www.wago.com/870-404



Item no.: 870-405
Push-in type jumper bar; insulated; 5-way; Nominal current 18 A

www.wago.com/870-405



Item no.: 870-405/011-000
Ready-made push-in type jumper bar; insulated; 3-way (1-3-5); Nominal current 18 A

www.wago.com/870-405/011-000



Item no.: 870-406
Push-in type jumper bar; insulated; 6-way; Nominal current 18 A

www.wago.com/870-406



Item no.: 870-407
Push-in type jumper bar; insulated; 7-way; Nominal current 18 A

www.wago.com/870-407



Item no.: 870-407/011-000
Ready-made push-in type jumper bar; insulated; 3-way (1-3-5); Nominal current 18 A

www.wago.com/870-407/011-000



Item no.: 870-408
Push-in type jumper bar; insulated; 8-way; Nominal current 18 A

www.wago.com/870-408



Item no.: 870-409
Push-in type jumper bar; insulated; 9-way; Nominal current 18 A

www.wago.com/870-409



Item no.: 870-409/011-000
Ready-made push-in type jumper bar; insulated; 3-way (1-3-5); Nominal current 18 A

www.wago.com/870-409/011-000



Item no.: 870-410
Push-in type jumper bar; insulated; 10-way; Nominal current 18 A

www.wago.com/870-410









Item no.: 870-433
Push-in type jumper bar; insulated; from 1 to 3; Nominal current 18 A

www.wago.com/870-433



Item no.: 870-434
Push-in type jumper bar; insulated; from 1 to 4; Nominal current 18 A

www.wago.com/870-434

	Item no.: 870-435 Push-in type jumper bar; insulated; from 1 to 5; Nominal current 18 A	www.wago.com/870-435
	Item no.: 870-436 Push-in type jumper bar; insulated; from 1 to 6; Nominal current 18 A	www.wago.com/870-436
	Item no.: 870-437 Push-in type jumper bar; insulated; from 1 to 7; Nominal current 18 A	www.wago.com/870-437
	Item no.: 870-438 Push-in type jumper bar; insulated; from 1 to 8; Nominal current 18 A	www.wago.com/870-438
	Item no.: 870-439 Push-in type jumper bar; insulated; from 1 to 9; Nominal current 18 A	www.wago.com/870-439
	Item no.: 870-440 Push-in type jumper bar; insulated; from 1 to 10; Nominal current 18 A	www.wago.com/870-440







End plate















	Item no.: 870-568 End and intermediate plate; 2 mm thick	www.wago.com/870-568
	Item no.: 870-569 End and intermediate plate; 2 mm thick	www.wago.com/870-569

Protective Warning Marker

	Item no.: 280-405 Protective warning marker; with high-voltage symbol, black; for 5 terminal blocks	www.wago.com/280-405
--	---	--

Marking accessories

	Item no.: 2009-115 WMB-Inline; for smartPRINTER; on reel; stretchable 5 - 5.2 mm; plain; snap-on type	www.wago.com/2009-115
	Item no.: 2009-115/000-002 WMB-Inline; for smartPRINTER; on reel; stretchable 5 - 5.2 mm; plain; snap-on type	www.wago.com/2009-115/000-002
	Item no.: 2009-115/000-006 WMB-Inline; for smartPRINTER; on reel; stretchable 5 - 5.2 mm; plain; snap-on type	www.wago.com/2009-115/000-006
	Item no.: 2009-115/000-007 WMB-Inline; for smartPRINTER; on reel; stretchable 5 - 5.2 mm; plain; snap-on type	www.wago.com/2009-115/000-007
	Item no.: 2009-115/000-012 WMB-Inline; for smartPRINTER; on reel; stretchable 5 - 5.2 mm; plain; snap-on type	www.wago.com/2009-115/000-012
	Item no.: 2009-115/000-017 WMB-Inline; for smartPRINTER; on reel; stretchable 5 - 5.2 mm; plain; snap-on type	www.wago.com/2009-115/000-017
	Item no.: 2009-115/000-023 WMB-Inline; for smartPRINTER; on reel; stretchable 5 - 5.2 mm; plain; snap-on type	www.wago.com/2009-115/000-023

	Item no.: 2009-115/000-024 WMB-Inline; for smartPRINTER; on reel; stretchable 5 - 5.2 mm; plain; snap-on type	www.wago.com/2009-115/000-024
	Item no.: 2009-145 Mini-WSB Inline; for smartPRINTER; on reel; stretchable 5 - 5.2 mm; plain; snap-on type	www.wago.com/2009-145
	Item no.: 2009-145/000-002 Mini-WSB Inline; for smartPRINTER; on reel; stretchable 5 - 5.2 mm; plain; snap-on type	www.wago.com/2009-145/000-002
	Item no.: 2009-145/000-005 Mini-WSB Inline; for smartPRINTER; on reel; stretchable 5 - 5.2 mm; plain; snap-on type	www.wago.com/2009-145/000-005
	Item no.: 2009-145/000-006 Mini-WSB Inline; for smartPRINTER; on reel; stretchable 5 - 5.2 mm; plain; snap-on type	www.wago.com/2009-145/000-006
	Item no.: 2009-145/000-007 Mini-WSB Inline; for smartPRINTER; on reel; stretchable 5 - 5.2 mm; plain; snap-on type	www.wago.com/2009-145/000-007
	Item no.: 2009-145/000-012 Mini-WSB Inline; for smartPRINTER; on reel; stretchable 5 - 5.2 mm; plain; snap-on type	www.wago.com/2009-145/000-012
	Item no.: 2009-145/000-023 Mini-WSB Inline; for smartPRINTER; on reel; stretchable 5 - 5.2 mm; plain; snap-on type	www.wago.com/2009-145/000-023
	Item no.: 2009-145/000-024 Mini-WSB Inline; on reel; stretchable 5 - 5.2 mm; plain; snap-on type	www.wago.com/2009-145/000-024
	Item no.: 248-501 Miniature WSB Quick marking system; plain; Marker width 5 mm; 10 strips with 10 markers per card	www.wago.com/248-501
	Item no.: 248-501/000-002 Mini-WSB marking card; as card; not stretchable; plain; snap-on type	www.wago.com/248-501/000-002
	Item no.: 248-501/000-005 Mini-WSB marking card; as card; plain; snap-on type	www.wago.com/248-501/000-005
	Item no.: 248-501/000-006 Mini-WSB marking card; as card; not stretchable; plain; snap-on type	www.wago.com/248-501/000-006
	Item no.: 248-501/000-007 Mini-WSB marking card; as card; not stretchable; plain; snap-on type	www.wago.com/248-501/000-007



Item no.: 248-501/000-012
Mini-WSB marking card; as card; not stretchable; plain; snap-on type

www.wago.com/248-501/000-012



Item no.: 248-501/000-017
Mini-WSB marking card; as card; not stretchable; plain; snap-on type

www.wago.com/248-501/000-017



Item no.: 248-501/000-023
Mini-WSB marking card; as card; not stretchable; plain; snap-on type

www.wago.com/248-501/000-023



Item no.: 248-501/000-024
Mini-WSB marking card; as card; not stretchable; plain; snap-on type

www.wago.com/248-501/000-024



Item no.: 709-177
Marking strips; on reel; 7.5 mm wide; not stretchable; plain; snap-on type

www.wago.com/709-177



Item no.: 709-178
Marking strips; on reel; 7.5 mm wide; not stretchable; plain; snap-on type

www.wago.com/709-178



Item no.: 709-196
Marking strips; for laser printer

www.wago.com/709-196



Item no.: 793-501
WMB marking card; as card; not stretchable; plain; snap-on type

www.wago.com/793-501



Item no.: 793-501/000-002
WMB marking card; as card; not stretchable; plain; snap-on type

www.wago.com/793-501/000-002



Item no.: 793-501/000-005
WMB marking card; as card; not stretchable; plain; snap-on type

www.wago.com/793-501/000-005



Item no.: 793-501/000-006
WMB marking card; as card; not stretchable; plain; snap-on type

www.wago.com/793-501/000-006



Item no.: 793-501/000-007
WMB marking card; as card; not stretchable; plain; snap-on type

www.wago.com/793-501/000-007



Item no.: 793-501/000-012
WMB marking card; as card; not stretchable; plain; snap-on type

www.wago.com/793-501/000-012



Item no.: 793-501/000-017
WMB marking card; as card; not stretchable; plain; snap-on type

www.wago.com/793-501/000-017

















Item no.: 793-501/000-023
WMB marking card; as card; not stretchable; plain; snap-on type



















www.wago.com/793-501/000-023





Item no.: 793-501/000-024
WMB marking card; as card; not stretchable; plain; snap-on type

www.wago.com/793-501/000-024

	Item no.: 793-5501 WMB marking card; as card; for terminal block width 5 - 17.5 mm; stretchable 5 - 5.2 mm; plain; snap-on type	www.wago.com/793-5501
	Item no.: 793-5501/000-002 WMB marking card; as card; for terminal block width 5 - 17.5 mm; stretchable 5 - 5.2 mm; plain; snap-on type	www.wago.com/793-5501/000-002
	Item no.: 793-5501/000-005 WMB marking card; as card; stretchable 5 - 5.2 mm; plain; snap-on type	www.wago.com/793-5501/000-005
	Item no.: 793-5501/000-006 WMB marking card; as card; stretchable 5 - 5.2 mm; plain; snap-on type	www.wago.com/793-5501/000-006
	Item no.: 793-5501/000-007 WMB marking card; as card; stretchable 5 - 5.2 mm; plain; snap-on type	www.wago.com/793-5501/000-007
	Item no.: 793-5501/000-012 WMB marking card; as card; stretchable 5 - 5.2 mm; plain; snap-on type	www.wago.com/793-5501/000-012
	Item no.: 793-5501/000-017 WMB marking card; as card; stretchable 5 - 5.2 mm; plain; snap-on type	www.wago.com/793-5501/000-017
	Item no.: 793-5501/000-023 WMB marking card; as card; stretchable 5 - 5.2 mm; plain; snap-on type	www.wago.com/793-5501/000-023
	Item no.: 793-5501/000-024 WMB marking card; as card; stretchable 5 - 5.2 mm; plain; snap-on type	www.wago.com/793-5501/000-024
assembling		
	Item no.: 209-106 Mounting carrier; for isolated mounting on DIN 35 rails	www.wago.com/209-106
	Item no.: 249-116 Screwless end stop; 6 mm wide	www.wago.com/249-116
	Item no.: 249-117 Screwless end stop; 10 mm wide	www.wago.com/249-117
ferrule		
	Item no.: 216-121 Ferrule; Sleeve for 0.5 mm ² / AWG 22; uninsulated; electro-tin plated	www.wago.com/216-121
	Item no.: 216-122 Ferrule; Sleeve for 0.75 mm ² / AWG 20; uninsulated; electro-tin plated	www.wago.com/216-122
	Item no.: 216-123 Ferrule; Sleeve for 1 mm ² / AWG 18; uninsulated; electro-tin plated	www.wago.com/216-123

	Item no.: 216-124 Ferrule; Sleeve for 1.5 mm ² / AWG 16; uninsulated; electro-tin plated	www.wago.com/216-124
	Item no.: 216-131 Ferrule; Sleeve for 0.25 mm ² / AWG 24; uninsulated; electro-tin plated	www.wago.com/216-131
	Item no.: 216-132 Ferrule; Sleeve for 0.34 mm ² / AWG 24; uninsulated; electro-tin plated	www.wago.com/216-132
	Item no.: 216-221 Ferrule; Sleeve for 0.5 mm ² / AWG 22; insulated; electro-tin plated	www.wago.com/216-221
	Item no.: 216-222 Ferrule; Sleeve for 0.75 mm ² / AWG 20; insulated; electro-tin plated	www.wago.com/216-222
	Item no.: 216-223 Ferrule; Sleeve for 1 mm ² / AWG 18; insulated; electro-tin plated	www.wago.com/216-223
	Item no.: 216-224 Ferrule; Sleeve for 1.5 mm ² / AWG 16; insulated; electro-tin plated	www.wago.com/216-224
	Item no.: 216-321 Ferrule; Sleeve for 0.25 mm ² / AWG 24; insulated; electro-tin plated	www.wago.com/216-321
	Item no.: 216-322 Ferrule; Sleeve for 0.34 mm ² / AWG 24; insulated; electro-tin plated	www.wago.com/216-322
tools		
	Item no.: 210-657 Operating tool with partially insulated shaft; Blade (3.5 x 0.5) mm; short	www.wago.com/210-657
	Item no.: 210-658 Operating tool with partially insulated shaft; Blade (3.5 x 0.5) mm; short; angled	www.wago.com/210-658
	Item no.: 210-720 Operating tool with partially insulated shaft; Type 2, blade (3.5 x 0.5) mm	www.wago.com/210-720
Carrier rail		
	Item no.: 210-112 Steel carrier rail; 35 x 7.5 mm; 1 mm thick; 2 m long; slotted; according to EN 60715; "Hole width 25 mm	www.wago.com/210-112
	Item no.: 210-113 Steel carrier rail; 35 x 7.5 mm; 1 mm thick; 2 m long; unslotted; according to EN 60715	www.wago.com/210-113
	Item no.: 210-114 Steel carrier rail; 35 x 15 mm; 1.5 mm thick; 2 m long; unslotted; similar to EN 60715	www.wago.com/210-114
	Item no.: 210-115 Steel carrier rail; 35 x 7.5 mm; 1 mm thick; 2 m long; slotted; according to EN 60715; "Hole width 18 mm	www.wago.com/210-115
	Item no.: 210-118 Steel carrier rail; 35 x 15 mm; 2.3 mm thick; 2 m long; unslotted; according to EN 60715	www.wago.com/210-118
	Item no.: 210-196 Aluminum carrier rail; 35 x 8.2 mm; 1.6 mm thick; 2 m long; unslotted; similar to EN 60715	www.wago.com/210-196
	Item no.: 210-197	

 Steel carrier rail; 35 x 15 mm; 1.5 mm thick; 2 m long; slotted; similar to EN 60715 www.wago.com/210-197

 **Item no.: 210-504**
Steel carrier rail; 35 x 7.5 mm; 1 mm thick; 2 m long; slotted; galvanized; according to EN 60715 www.wago.com/210-504

 **Item no.: 210-505**
Steel carrier rail; 35 x 7.5 mm; 1 mm thick; 2 m long; unslotted; galvanized; according to EN 60715 www.wago.com/210-505

 **Item no.: 210-506**
Steel carrier rail; 35 x 15 mm; 1.5 mm thick; 2 m long; unslotted; galvanized; similar to EN 60715 www.wago.com/210-506

 **Item no.: 210-508**
Steel carrier rail; 35 x 15 mm; 1.5 mm thick; 2 m long; slotted; galvanized; similar to EN 60715 www.wago.com/210-508

Insulation stop

 **Item no.: 280-470**
Insulation stop; 0.08 - 0.2 mm² "s" (0.14 mm² "f-st"); 5 pieces/strip www.wago.com/280-470

 **Item no.: 280-471**
Insulation stop; 0.25 - 0.5 mm²; 5 pieces/strip www.wago.com/280-471

 **Item no.: 280-472**
Insulation stop; 0.75 - 1 mm²; 5 pieces/strip www.wago.com/280-472

Downloads

Documentation

Bid Text

870-567	Oct 20, 2017	DOC 25.6 kB	Download
---------	--------------	----------------	----------

smartDATA

CAD data

3D Download 870-567	URL	Download
---------------------	-----	----------

Subject to changes.