

Data sheet | Item number: 870-904

2-conductor through terminal block; 2.5 mm²; suitable for Ex i applications; side and center marking; for DIN-rail 35 x 15 and 35 x 7.5; CAGE CLAMP®

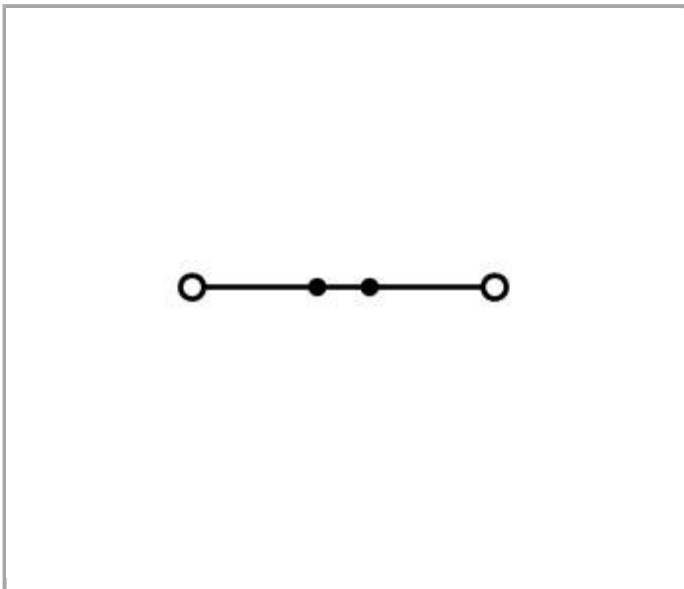

www.wago.com/870-904

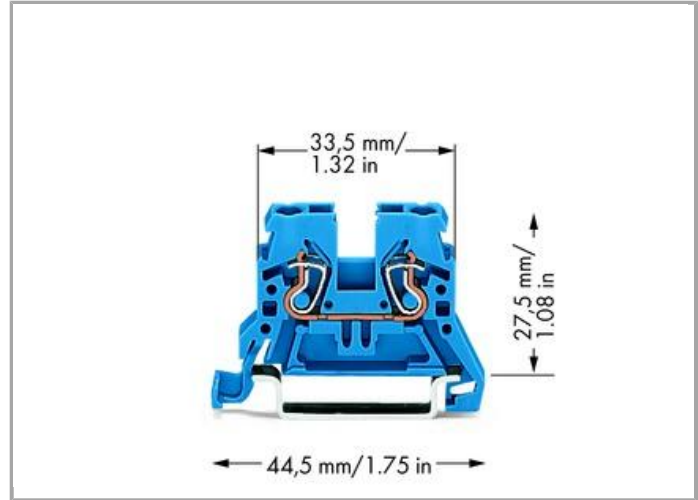
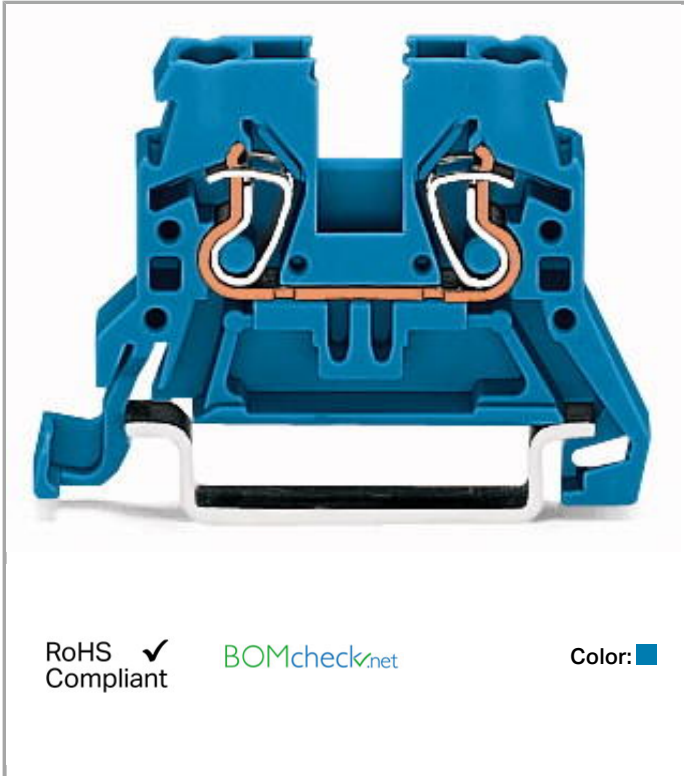

Data
Electrical data



Ratings per IEC/EN 60664-1

Rated voltage (III / 3)	500 V
Rated impulse voltage (III / 3)	6 kV
Rated current	24 A
Legend (ratings)	(III / 3) $\hat{=}$ Overvoltage category III / Pollution degree 3

Connection data

Connection technology	CAGE CLAMP®
Actuation type	Operating tool
Connectable conductor materials	Copper Aluminum
Solid conductor	0.08 ... 2.5 mm ² / 28 ... 12 AWG
Fine-stranded conductor	0.08 ... 4 mm ² / 28 ... 12 AWG
Strip length	6 ... 7 mm / 0.24 ... 0.28 Inch
Total number of connection points	2
Total number of potentials	1
Number of levels	1
Type of wiring	Front-entry wiring

Geometrical Data

Width	5 mm / 0.197 inch
Height from upper-edge of DIN-35 rail	27.5 mm / 1.083 inch
Depth	44.5 mm / 1.752 inch

Mechanical data

Design	horizontal
Type of mounting	DIN-35 rail
Marking level	Side marking

Material Data

Color	blue
Insulating material	Polyamide 66 (PA 66)
Fire load	0.08 MJ
Weight	4.313 g

Commercial data

Country of origin	DE
GTIN	4044918478380
Customs Tariff No.	85369010000

Product Group



16 (Rail Mounted Terminal Block with CCC)

Approvals / Certificates

Country specific Approvals

Logo	Approval	Certificate name
	CCA DEKRA Certification B.V.	2189801.01
	CCA DEKRA Certification B.V.	NTR NL 7468

Ship Approvals

Logo	Approval	Certificate name
	ABS American Bureau of Shipping	14-HG1293677-PDA
	BV Bureau Veritas S.A.	07436/E0 BV
	LR Lloyds Register	91/20112 (E9)



















UL-Approvals

Logo	Approval	Certificate name
	cURus UL International Germany GmbH	E45172

















Compatible products





General accessories

	Item no.: 870-182 Adaptor	www.wago.com/870-182
	Item no.: 870-183 Adaptor	www.wago.com/870-183
	Item no.: 870-184 Adaptor	www.wago.com/870-184











	Item no.: 870-425 Tap-off module; with anti-rotation protection; modular; suitable for 870 Series terminal blocks with jumper slots in the current bar	www.wago.com/870-425
	Item no.: 870-426 Tap-off module; modular; suitable for 870 Series terminal blocks with jumper slots in the current bar	www.wago.com/870-426
	Item no.: 870-427 Spacer module; modular; bridging commoned terminal blocks	www.wago.com/870-427
ferrule		
	Item no.: 216-121 Ferrule; Sleeve for 0.5 mm ² / AWG 22; uninsulated; electro-tin plated	www.wago.com/216-121
	Item no.: 216-122 Ferrule; Sleeve for 0.75 mm ² / AWG 20; uninsulated; electro-tin plated	www.wago.com/216-122
	Item no.: 216-123 Ferrule; Sleeve for 1 mm ² / AWG 18; uninsulated; electro-tin plated	www.wago.com/216-123
	Item no.: 216-124 Ferrule; Sleeve for 1.5 mm ² / AWG 16; uninsulated; electro-tin plated	www.wago.com/216-124
	Item no.: 216-131 Ferrule; Sleeve for 0.25 mm ² / AWG 24; uninsulated; electro-tin plated	www.wago.com/216-131
	Item no.: 216-132 Ferrule; Sleeve for 0.34 mm ² / AWG 24; uninsulated; electro-tin plated	www.wago.com/216-132
	Item no.: 216-221 Ferrule; Sleeve for 0.5 mm ² / AWG 22; insulated; electro-tin plated	www.wago.com/216-221
	Item no.: 216-222 Ferrule; Sleeve for 0.75 mm ² / AWG 20; insulated; electro-tin plated	www.wago.com/216-222
	Item no.: 216-223 Ferrule; Sleeve for 1 mm ² / AWG 18; insulated; electro-tin plated	www.wago.com/216-223
	Item no.: 216-224 Ferrule; Sleeve for 1.5 mm ² / AWG 16; insulated; electro-tin plated	www.wago.com/216-224
	Item no.: 216-321 Ferrule; Sleeve for 0.25 mm ² / AWG 24; insulated; electro-tin plated	www.wago.com/216-321
	Item no.: 216-322 Ferrule; Sleeve for 0.34 mm ² / AWG 24; insulated; electro-tin plated	www.wago.com/216-322
tools		
	Item no.: 210-657 Operating tool with partially insulated shaft; Blade (3.5 x 0.5) mm; short	www.wago.com/210-657
	Item no.: 210-658 Operating tool with partially insulated shaft; Blade (3.5 x 0.5) mm; short; angled	www.wago.com/210-658
	Item no.: 210-720 Operating tool with partially insulated shaft; Type 2, blade (3.5 x 0.5) mm	www.wago.com/210-720















Jumper















	Item no.: 709-110 Wire commoning chain; insulated; 4 connections; 3 x 110 mm	www.wago.com/709-110
	Item no.: 709-111 Wire commoning chain; insulated; 3 connections; 2 x 120 mm	www.wago.com/709-111
	Item no.: 709-112 Wire commoning chain; insulated; 3 connections; 2 x 170 mm	www.wago.com/709-112
	Item no.: 870-402 Push-in type jumper bar; insulated; 2-way; Nominal current 18 A	www.wago.com/870-402
	Item no.: 870-403 Push-in type jumper bar; insulated; 3-way; Nominal current 18 A	www.wago.com/870-403
	Item no.: 870-404 Push-in type jumper bar; insulated; 4-way; Nominal current 18 A	www.wago.com/870-404
	Item no.: 870-405 Push-in type jumper bar; insulated; 5-way; Nominal current 18 A	www.wago.com/870-405
	Item no.: 870-405/011-000 Ready-made push-in type jumper bar; insulated; 3-way (1-3-5); Nominal current 18 A	www.wago.com/870-405/011-000
	Item no.: 870-406 Push-in type jumper bar; insulated; 6-way; Nominal current 18 A	www.wago.com/870-406
	Item no.: 870-407 Push-in type jumper bar; insulated; 7-way; Nominal current 18 A	www.wago.com/870-407
	Item no.: 870-407/011-000 Ready-made push-in type jumper bar; insulated; 3-way (1-3-5); Nominal current 18 A	www.wago.com/870-407/011-000
	Item no.: 870-408 Push-in type jumper bar; insulated; 8-way; Nominal current 18 A	www.wago.com/870-408
	Item no.: 870-409 Push-in type jumper bar; insulated; 9-way; Nominal current 18 A	www.wago.com/870-409
	Item no.: 870-409/011-000 Ready-made push-in type jumper bar; insulated; 3-way (1-3-5); Nominal current 18 A	www.wago.com/870-409/011-000
	Item no.: 870-410 Push-in type jumper bar; insulated; 10-way; Nominal current 18 A	www.wago.com/870-410
	Item no.: 870-433 Push-in type jumper bar; insulated; from 1 to 3; Nominal current 18 A	www.wago.com/870-433
	Item no.: 870-434 Push-in type jumper bar; insulated; from 1 to 4; Nominal current 18 A	www.wago.com/870-434
	Item no.: 870-435 Push-in type jumper bar; insulated; from 1 to 5; Nominal current 18 A	www.wago.com/870-435
	Item no.: 870-436	

	Push-in type jumper bar; insulated; from 1 to 6; Nominal current 18 A	www.wago.com/870-436
	Item no.: 870-437 Push-in type jumper bar; insulated; from 1 to 7; Nominal current 18 A	www.wago.com/870-437
	Item no.: 870-438 Push-in type jumper bar; insulated; from 1 to 8; Nominal current 18 A	www.wago.com/870-438
	Item no.: 870-439 Push-in type jumper bar; insulated; from 1 to 9; Nominal current 18 A	www.wago.com/870-439
	Item no.: 870-440 Push-in type jumper bar; insulated; from 1 to 10; Nominal current 18 A	www.wago.com/870-440

Marking accessories

	Item no.: 2009-115 WMB-Inline; for smartPRINTER; on reel; stretchable 5 - 5.2 mm; plain; snap-on type	www.wago.com/2009-115
	Item no.: 2009-115/000-002 WMB-Inline; for smartPRINTER; on reel; stretchable 5 - 5.2 mm; plain; snap-on type	www.wago.com/2009-115/000-002
	Item no.: 2009-115/000-006 WMB-Inline; for smartPRINTER; on reel; stretchable 5 - 5.2 mm; plain; snap-on type	www.wago.com/2009-115/000-006
	Item no.: 2009-115/000-007 WMB-Inline; for smartPRINTER; on reel; stretchable 5 - 5.2 mm; plain; snap-on type	www.wago.com/2009-115/000-007
	Item no.: 2009-115/000-012 WMB-Inline; for smartPRINTER; on reel; stretchable 5 - 5.2 mm; plain; snap-on type	www.wago.com/2009-115/000-012
	Item no.: 2009-115/000-017 WMB-Inline; for smartPRINTER; on reel; stretchable 5 - 5.2 mm; plain; snap-on type	www.wago.com/2009-115/000-017
	Item no.: 2009-115/000-023 WMB-Inline; for smartPRINTER; on reel; stretchable 5 - 5.2 mm; plain; snap-on type	www.wago.com/2009-115/000-023
	Item no.: 2009-115/000-024 WMB-Inline; for smartPRINTER; on reel; stretchable 5 - 5.2 mm; plain; snap-on type	www.wago.com/2009-115/000-024
	Item no.: 2009-145 Mini-WSB Inline; for smartPRINTER; on reel; stretchable 5 - 5.2 mm; plain; snap-on type	www.wago.com/2009-145
	Item no.: 2009-145/000-002 Mini-WSB Inline; for smartPRINTER; on reel; stretchable 5 - 5.2 mm; plain; snap-on type	www.wago.com/2009-145/000-002
	Item no.: 2009-145/000-005 Mini-WSB Inline; for smartPRINTER; on reel; stretchable 5 - 5.2 mm; plain; snap-on type	www.wago.com/2009-145/000-005

	<p>Item no.: 2009-145/000-006 Mini-WSB Inline; for smartPRINTER; on reel; stretchable 5 - 5.2 mm; plain; snap-on type</p>	www.wago.com/2009-145/000-006
	<p>Item no.: 2009-145/000-007 Mini-WSB Inline; for smartPRINTER; on reel; stretchable 5 - 5.2 mm; plain; snap-on type</p>	www.wago.com/2009-145/000-007
	<p>Item no.: 2009-145/000-012 Mini-WSB Inline; for smartPRINTER; on reel; stretchable 5 - 5.2 mm; plain; snap-on type</p>	www.wago.com/2009-145/000-012
	<p>Item no.: 2009-145/000-023 Mini-WSB Inline; for smartPRINTER; on reel; stretchable 5 - 5.2 mm; plain; snap-on type</p>	www.wago.com/2009-145/000-023
	<p>Item no.: 2009-145/000-024 Mini-WSB Inline; on reel; stretchable 5 - 5.2 mm; plain; snap-on type</p>	www.wago.com/2009-145/000-024
	<p>Item no.: 248-501 Miniature WSB Quick marking system; plain; Marker width 5 mm; 10 strips with 10 markers per card</p>	www.wago.com/248-501
	<p>Item no.: 248-501/000-002 Mini-WSB marking card; as card; not stretchable; plain; snap-on type</p>	www.wago.com/248-501/000-002
	<p>Item no.: 248-501/000-005 Mini-WSB marking card; as card; plain; snap-on type</p>	www.wago.com/248-501/000-005
	<p>Item no.: 248-501/000-006 Mini-WSB marking card; as card; not stretchable; plain; snap-on type</p>	www.wago.com/248-501/000-006
	<p>Item no.: 248-501/000-007 Mini-WSB marking card; as card; not stretchable; plain; snap-on type</p>	www.wago.com/248-501/000-007
	<p>Item no.: 248-501/000-012 Mini-WSB marking card; as card; not stretchable; plain; snap-on type</p>	www.wago.com/248-501/000-012
	<p>Item no.: 248-501/000-017 Mini-WSB marking card; as card; not stretchable; plain; snap-on type</p>	www.wago.com/248-501/000-017
	<p>Item no.: 248-501/000-023 Mini-WSB marking card; as card; not stretchable; plain; snap-on type</p>	www.wago.com/248-501/000-023
	<p>Item no.: 248-501/000-024 Mini-WSB marking card; as card; not stretchable; plain; snap-on type</p>	www.wago.com/248-501/000-024
	<p>Item no.: 709-177 Marking strips; on reel; 7.5 mm wide; not stretchable; plain; snap-on type</p>	www.wago.com/709-177

	Item no.: 709-178 Marking strips; on reel; 7.5 mm wide; not stretchable; plain; snap-on type	www.wago.com/709-178
	Item no.: 709-196 Marking strips; for laser printer	www.wago.com/709-196
	Item no.: 793-501 WMB marking card; as card; not stretchable; plain; snap-on type	www.wago.com/793-501
	Item no.: 793-501/000-002 WMB marking card; as card; not stretchable; plain; snap-on type	www.wago.com/793-501/000-002
	Item no.: 793-501/000-005 WMB marking card; as card; not stretchable; plain; snap-on type	www.wago.com/793-501/000-005
	Item no.: 793-501/000-006 WMB marking card; as card; not stretchable; plain; snap-on type	www.wago.com/793-501/000-006
	Item no.: 793-501/000-007 WMB marking card; as card; not stretchable; plain; snap-on type	www.wago.com/793-501/000-007
	Item no.: 793-501/000-012 WMB marking card; as card; not stretchable; plain; snap-on type	www.wago.com/793-501/000-012
	Item no.: 793-501/000-017 WMB marking card; as card; not stretchable; plain; snap-on type	www.wago.com/793-501/000-017
	Item no.: 793-501/000-023 WMB marking card; as card; not stretchable; plain; snap-on type	www.wago.com/793-501/000-023
	Item no.: 793-501/000-024 WMB marking card; as card; not stretchable; plain; snap-on type	www.wago.com/793-501/000-024
	Item no.: 793-5501 WMB marking card; as card; for terminal block width 5 - 17.5 mm; stretchable 5 - 5.2 mm; plain; snap-on type	www.wago.com/793-5501
	Item no.: 793-5501/000-002 WMB marking card; as card; for terminal block width 5 - 17.5 mm; stretchable 5 - 5.2 mm; plain; snap-on type	www.wago.com/793-5501/000-002
	Item no.: 793-5501/000-005 WMB marking card; as card; stretchable 5 - 5.2 mm; plain; snap-on type	www.wago.com/793-5501/000-005
	Item no.: 793-5501/000-006 WMB marking card; as card; stretchable 5 - 5.2 mm; plain; snap-on type	www.wago.com/793-5501/000-006
	Item no.: 793-5501/000-007 WMB marking card; as card; stretchable 5 - 5.2 mm; plain; snap-on type	www.wago.com/793-5501/000-007



Item no.: 793-5501/000-012
WMB marking card; as card; stretchable 5 - 5.2 mm; plain; snap-on type

www.wago.com/793-5501/000-012



Item no.: 793-5501/000-017
WMB marking card; as card; stretchable 5 - 5.2 mm; plain; snap-on type

www.wago.com/793-5501/000-017



Item no.: 793-5501/000-023
WMB marking card; as card; stretchable 5 - 5.2 mm; plain; snap-on type

www.wago.com/793-5501/000-023



Item no.: 793-5501/000-024
WMB marking card; as card; stretchable 5 - 5.2 mm; plain; snap-on type

www.wago.com/793-5501/000-024

Protective Warning Marker



Item no.: 280-405
Protective warning marker; with high-voltage symbol, black; for 5 terminal blocks

www.wago.com/280-405

Carrier rail



Item no.: 210-112
Steel carrier rail; 35 x 7.5 mm; 1 mm thick; 2 m long; slotted; according to EN 60715; "Hole width 25 mm

www.wago.com/210-112



Item no.: 210-113
Steel carrier rail; 35 x 7.5 mm; 1 mm thick; 2 m long; unslotted; according to EN 60715

www.wago.com/210-113



Item no.: 210-114
Steel carrier rail; 35 x 15 mm; 1.5 mm thick; 2 m long; unslotted; similar to EN 60715

www.wago.com/210-114



Item no.: 210-115
Steel carrier rail; 35 x 7.5 mm; 1 mm thick; 2 m long; slotted; according to EN 60715; "Hole width 18 mm

www.wago.com/210-115



Item no.: 210-118
Steel carrier rail; 35 x 15 mm; 2.3 mm thick; 2 m long; unslotted; according to EN 60715

www.wago.com/210-118



Item no.: 210-196
Aluminum carrier rail; 35 x 8.2 mm; 1.6 mm thick; 2 m long; unslotted; similar to EN 60715

www.wago.com/210-196



Item no.: 210-197
Steel carrier rail; 35 x 15 mm; 1.5 mm thick; 2 m long; slotted; similar to EN 60715

www.wago.com/210-197



Item no.: 210-504
Steel carrier rail; 35 x 7.5 mm; 1 mm thick; 2 m long; slotted; galvanized; according to EN 60715

www.wago.com/210-504



Item no.: 210-505
Steel carrier rail; 35 x 7.5 mm; 1 mm thick; 2 m long; unslotted; galvanized; according to EN 60715

www.wago.com/210-505



Item no.: 210-506
Steel carrier rail; 35 x 15 mm; 1.5 mm thick; 2 m long; unslotted; galvanized; similar to EN 60715

www.wago.com/210-506





Item no.: 210-508
Steel carrier rail; 35 x 15 mm; 1.5 mm thick; 2 m long; slotted; galvanized; similar to EN 60715

www.wago.com/210-508



End plate

	Item no.: 870-923 End and intermediate plate; 2 mm thick	www.wago.com/870-923
	Item no.: 870-924 End and intermediate plate; 2 mm thick	www.wago.com/870-924
	Item no.: 870-928 Separator plate; 2 mm thick; oversized	www.wago.com/870-928
	Item no.: 870-929 Separator plate; 2 mm thick; oversized	www.wago.com/870-929

assembling

	Item no.: 209-106 Mounting carrier; for isolated mounting on DIN 35 rails	www.wago.com/209-106
	Item no.: 249-116 Screwless end stop; 6 mm wide	www.wago.com/249-116
	Item no.: 249-117 Screwless end stop; 10 mm wide	www.wago.com/249-117

Insulation stop

	Item no.: 280-470 Insulation stop; 0.08 - 0.2 mm ² "s" (0.14 mm ² "f-st"); 5 pieces/strip	www.wago.com/280-470
	Item no.: 280-471 Insulation stop; 0.25 - 0.5 mm ² ; 5 pieces/strip	www.wago.com/280-471
	Item no.: 280-472 Insulation stop; 0.75 - 1 mm ² ; 5 pieces/strip	www.wago.com/280-472

Downloads

Documentation

Bid Text

870-904	Oct 20, 2017	DOC 25.1 kB	Download
---------	--------------	----------------	----------

smartDATA

CAD data

3D Download 870-904	URL	Download
---------------------	-----	----------



Subject to changes.

WAGO Kontakttechnik GmbH & Co. KG
Hansastr. 27
32423 Minden
Phone: +49571 887-0 | Fax: +49571 887-169
Email: info.de@wago.com | Web: www.wago.com

Do you have any questions about our products?
We are always happy to take your call at +49 (571) 887-44222.