

Data sheet | Item number: 870-911

2-conductor through terminal block; 2.5 mm<sup>2</sup>; side and center marking; for DIN-15 rail; CAGE CLAMP®

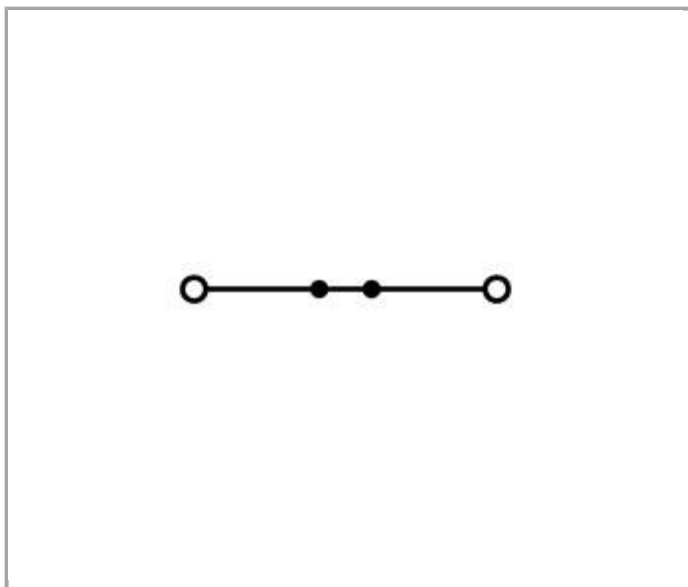

[www.wago.com/870-911](http://www.wago.com/870-911)

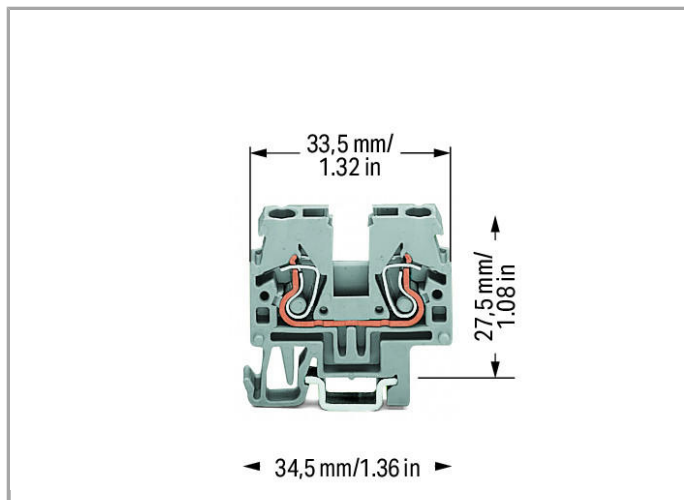
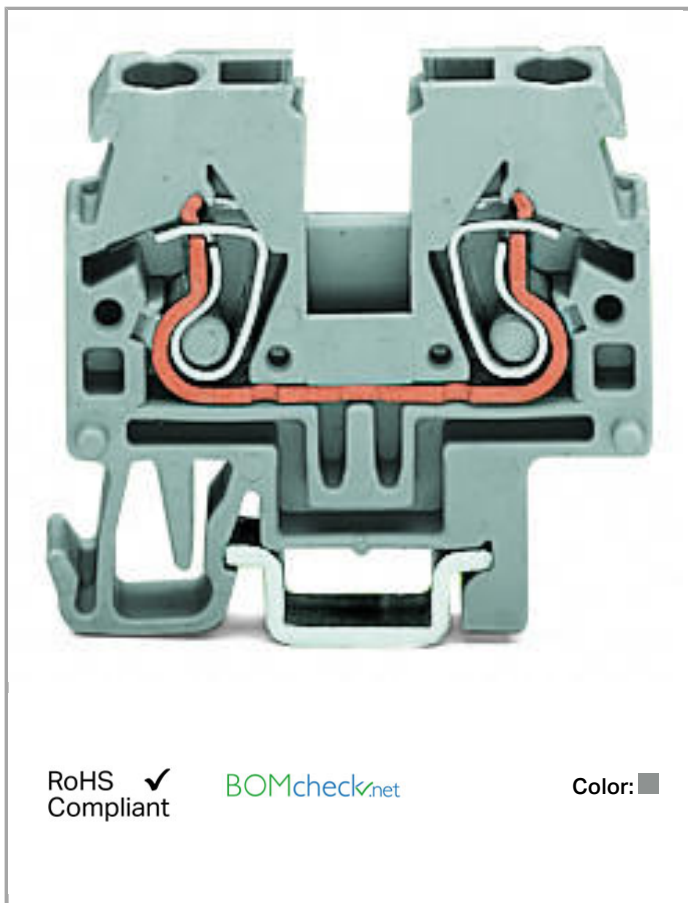

## Data

### Electrical data

#### Ratings per IEC/EN 60664-1

Rated voltage (III / 3)	500 V
Rated impulse voltage (III / 3)	6 kV
Rated current	24 A
Legend (ratings)	(III / 3) $\triangleq$ Overvoltage category III / Pollution degree 3

### Connection data

Connection technology	CAGE CLAMP®
Actuation type	Operating tool
Connectable conductor materials	Copper Aluminum
Solid conductor	0.08 ... 2.5 mm <sup>2</sup> / 28 ... 12 AWG
Fine-stranded conductor	0.08 ... 4 mm <sup>2</sup> / 28 ... 12 AWG
Strip length	6 ... 7 mm / 0.24 ... 0.28 Inch
Total number of connection points	2
Total number of potentials	1
Number of levels	1
Type of wiring	Front-entry wiring

### Geometrical Data

Width	5 mm / 0.197 inch
Height from upper-edge of DIN-35 rail	26.5 mm / 1.043 inch
Depth	34.5 mm / 1.358 inch

### Mechanical data

Design	horizontal
Type of mounting	DIN-15 rail
Marking level	Side marking

### Material Data



Color	gray
Insulating material	Polyamide 66 (PA 66)
Fire load	0.07 MJ
Weight	3.963 g

## Commercial data

Country of origin	DE
GTIN	4044918478458
Customs Tariff No.	85369010000
Product Group	16 (Rail Mounted Terminal Block with CCC)

## Approvals / Certificates

### Country specific Approvals

Logo	Approval	Certificate name
	CCA DEKRA Certification B.V.	NTR NL 7468
	CCA DEKRA Certification B.V.	2189801.01

### Ship Approvals





Logo	Approval	Certificate name
	ABS American Bureau of Shipping	14-HG1293677-PDA









### UL-Approvals

Logo	Approval	Certificate name
	cURus UL International Germany GmbH	E45172



## Compatible products

### ferrule







	Item no.: 216-121 Ferrule; Sleeve for 0.5 mm <sup>2</sup> / AWG 22; uninsulated; electro-tin plated	<a href="http://www.wago.com/216-121">www.wago.com/216-121</a>
	Item no.: 216-122 Ferrule; Sleeve for 0.75 mm <sup>2</sup> / AWG 20; uninsulated; electro-tin plated	<a href="http://www.wago.com/216-122">www.wago.com/216-122</a>
	Item no.: 216-123 Ferrule; Sleeve for 1 mm <sup>2</sup> / AWG 18; uninsulated; electro-tin plated	<a href="http://www.wago.com/216-123">www.wago.com/216-123</a>
	Item no.: 216-124 Ferrule; Sleeve for 1.5 mm <sup>2</sup> / AWG 16; uninsulated; electro-tin plated	<a href="http://www.wago.com/216-124">www.wago.com/216-124</a>

	<b>Item no.: 216-131</b> Ferrule; Sleeve for 0.25 mm <sup>2</sup> / AWG 24; uninsulated; electro-tin plated	<a href="http://www.wago.com/216-131">www.wago.com/216-131</a>
	<b>Item no.: 216-132</b> Ferrule; Sleeve for 0.34 mm <sup>2</sup> / AWG 24; uninsulated; electro-tin plated	<a href="http://www.wago.com/216-132">www.wago.com/216-132</a>
	<b>Item no.: 216-221</b> Ferrule; Sleeve for 0.5 mm <sup>2</sup> / AWG 22; insulated; electro-tin plated	<a href="http://www.wago.com/216-221">www.wago.com/216-221</a>
	<b>Item no.: 216-222</b> Ferrule; Sleeve for 0.75 mm <sup>2</sup> / AWG 20; insulated; electro-tin plated	<a href="http://www.wago.com/216-222">www.wago.com/216-222</a>
	<b>Item no.: 216-223</b> Ferrule; Sleeve for 1 mm <sup>2</sup> / AWG 18; insulated; electro-tin plated	<a href="http://www.wago.com/216-223">www.wago.com/216-223</a>
	<b>Item no.: 216-224</b> Ferrule; Sleeve for 1.5 mm <sup>2</sup> / AWG 16; insulated; electro-tin plated	<a href="http://www.wago.com/216-224">www.wago.com/216-224</a>
	<b>Item no.: 216-321</b> Ferrule; Sleeve for 0.25 mm <sup>2</sup> / AWG 24; insulated; electro-tin plated	<a href="http://www.wago.com/216-321">www.wago.com/216-321</a>
	<b>Item no.: 216-322</b> Ferrule; Sleeve for 0.34 mm <sup>2</sup> / AWG 24; insulated; electro-tin plated	<a href="http://www.wago.com/216-322">www.wago.com/216-322</a>

#### Carrier rail

	<b>Item no.: 210-111</b> Steel carrier rail; 15 x 5.5 mm; 1 mm thick; 2 m long; slotted; according to EN 60715	<a href="http://www.wago.com/210-111">www.wago.com/210-111</a>
	<b>Item no.: 210-295</b> Steel carrier rail; 15 x 5.5 mm; 1 mm thick; 2 m long; unslotted; according to EN 60715	<a href="http://www.wago.com/210-295">www.wago.com/210-295</a>
	<b>Item no.: 210-296</b> Aluminum carrier rail; 15 x 5.5 mm; 1 mm thick; 2 m long; unslotted; similar to EN 60715	<a href="http://www.wago.com/210-296">www.wago.com/210-296</a>

#### General accessories

	<b>Item no.: 870-182</b> Adaptor	<a href="http://www.wago.com/870-182">www.wago.com/870-182</a>
	<b>Item no.: 870-183</b> Adaptor	<a href="http://www.wago.com/870-183">www.wago.com/870-183</a>
	<b>Item no.: 870-184</b> Adaptor	<a href="http://www.wago.com/870-184">www.wago.com/870-184</a>
	<b>Item no.: 870-425</b> Tap-off module; with anti-rotation protection; modular; suitable for 870 Series terminal blocks with jumper slots in the current bar	<a href="http://www.wago.com/870-425">www.wago.com/870-425</a>
	<b>Item no.: 870-426</b> Tap-off module; modular; suitable for 870 Series terminal blocks with jumper slots in the current bar	<a href="http://www.wago.com/870-426">www.wago.com/870-426</a>
	<b>Item no.: 870-427</b> Spacer module; modular; bridging commoned terminal blocks	<a href="http://www.wago.com/870-427">www.wago.com/870-427</a>

#### tools



**Item no.: 210-657**  
Operating tool with partially insulated shaft; Blade (3.5 x 0.5) mm; short

[www.wago.com/210-657](http://www.wago.com/210-657)



**Item no.: 210-658**  
Operating tool with partially insulated shaft; Blade (3.5 x 0.5) mm; short; angled

[www.wago.com/210-658](http://www.wago.com/210-658)



**Item no.: 210-720**  
Operating tool with partially insulated shaft; Type 2, blade (3.5 x 0.5) mm

[www.wago.com/210-720](http://www.wago.com/210-720)

#### End plate



**Item no.: 870-923**  
End and intermediate plate; 2 mm thick

[www.wago.com/870-923](http://www.wago.com/870-923)



**Item no.: 870-924**  
End and intermediate plate; 2 mm thick

[www.wago.com/870-924](http://www.wago.com/870-924)



**Item no.: 870-928**  
Separator plate; 2 mm thick; oversized

[www.wago.com/870-928](http://www.wago.com/870-928)



**Item no.: 870-929**  
Separator plate; 2 mm thick; oversized

[www.wago.com/870-929](http://www.wago.com/870-929)

#### Marking accessories



**Item no.: 2009-115**  
WMB-Inline; for smartPRINTER; on reel; stretchable 5 - 5.2 mm; plain; snap-on type

[www.wago.com/2009-115](http://www.wago.com/2009-115)



**Item no.: 2009-115/000-002**  
WMB-Inline; for smartPRINTER; on reel; stretchable 5 - 5.2 mm; plain; snap-on type

[www.wago.com/2009-115/000-002](http://www.wago.com/2009-115/000-002)



**Item no.: 2009-115/000-006**  
WMB-Inline; for smartPRINTER; on reel; stretchable 5 - 5.2 mm; plain; snap-on type

[www.wago.com/2009-115/000-006](http://www.wago.com/2009-115/000-006)



**Item no.: 2009-115/000-007**  
WMB-Inline; for smartPRINTER; on reel; stretchable 5 - 5.2 mm; plain; snap-on type

[www.wago.com/2009-115/000-007](http://www.wago.com/2009-115/000-007)



**Item no.: 2009-115/000-012**  
WMB-Inline; for smartPRINTER; on reel; stretchable 5 - 5.2 mm; plain; snap-on type

[www.wago.com/2009-115/000-012](http://www.wago.com/2009-115/000-012)



**Item no.: 2009-115/000-017**  
WMB-Inline; for smartPRINTER; on reel; stretchable 5 - 5.2 mm; plain; snap-on type

[www.wago.com/2009-115/000-017](http://www.wago.com/2009-115/000-017)



**Item no.: 2009-115/000-023**  
WMB-Inline; for smartPRINTER; on reel; stretchable 5 - 5.2 mm; plain; snap-on type

[www.wago.com/2009-115/000-023](http://www.wago.com/2009-115/000-023)

















**Item no.: 2009-115/000-024**  
WMB-Inline; for smartPRINTER; on reel; stretchable 5 - 5.2 mm; plain; snap-on type

















[www.wago.com/2009-115/000-024](http://www.wago.com/2009-115/000-024)



**Item no.: 2009-145**  
Mini-WSB Inline; for smartPRINTER; on reel; stretchable 5 - 5.2 mm; plain; snap-on type

[www.wago.com/2009-145](http://www.wago.com/2009-145)

	<p><b>Item no.: 2009-145/000-002</b> Mini-WSB Inline; for smartPRINTER; on reel; stretchable 5 - 5.2 mm; plain; snap-on type</p>	<a href="http://www.wago.com/2009-145/000-002">www.wago.com/2009-145/000-002</a>
	<p><b>Item no.: 2009-145/000-005</b> Mini-WSB Inline; for smartPRINTER; on reel; stretchable 5 - 5.2 mm; plain; snap-on type</p>	<a href="http://www.wago.com/2009-145/000-005">www.wago.com/2009-145/000-005</a>
	<p><b>Item no.: 2009-145/000-006</b> Mini-WSB Inline; for smartPRINTER; on reel; stretchable 5 - 5.2 mm; plain; snap-on type</p>	<a href="http://www.wago.com/2009-145/000-006">www.wago.com/2009-145/000-006</a>
	<p><b>Item no.: 2009-145/000-007</b> Mini-WSB Inline; for smartPRINTER; on reel; stretchable 5 - 5.2 mm; plain; snap-on type</p>	<a href="http://www.wago.com/2009-145/000-007">www.wago.com/2009-145/000-007</a>
	<p><b>Item no.: 2009-145/000-012</b> Mini-WSB Inline; for smartPRINTER; on reel; stretchable 5 - 5.2 mm; plain; snap-on type</p>	<a href="http://www.wago.com/2009-145/000-012">www.wago.com/2009-145/000-012</a>
	<p><b>Item no.: 2009-145/000-023</b> Mini-WSB Inline; for smartPRINTER; on reel; stretchable 5 - 5.2 mm; plain; snap-on type</p>	<a href="http://www.wago.com/2009-145/000-023">www.wago.com/2009-145/000-023</a>
	<p><b>Item no.: 2009-145/000-024</b> Mini-WSB Inline; on reel; stretchable 5 - 5.2 mm; plain; snap-on type</p>	<a href="http://www.wago.com/2009-145/000-024">www.wago.com/2009-145/000-024</a>
	<p><b>Item no.: 248-501</b> Miniature WSB Quick marking system; plain; Marker width 5 mm; 10 strips with 10 markers per card</p>	<a href="http://www.wago.com/248-501">www.wago.com/248-501</a>
	<p><b>Item no.: 248-501/000-002</b> Mini-WSB marking card; as card; not stretchable; plain; snap-on type</p>	<a href="http://www.wago.com/248-501/000-002">www.wago.com/248-501/000-002</a>
	<p><b>Item no.: 248-501/000-005</b> Mini-WSB marking card; as card; plain; snap-on type</p>	<a href="http://www.wago.com/248-501/000-005">www.wago.com/248-501/000-005</a>
	<p><b>Item no.: 248-501/000-006</b> Mini-WSB marking card; as card; not stretchable; plain; snap-on type</p>	<a href="http://www.wago.com/248-501/000-006">www.wago.com/248-501/000-006</a>
	<p><b>Item no.: 248-501/000-007</b> Mini-WSB marking card; as card; not stretchable; plain; snap-on type</p>	<a href="http://www.wago.com/248-501/000-007">www.wago.com/248-501/000-007</a>
	<p><b>Item no.: 248-501/000-012</b> Mini-WSB marking card; as card; not stretchable; plain; snap-on type</p>	<a href="http://www.wago.com/248-501/000-012">www.wago.com/248-501/000-012</a>
	<p><b>Item no.: 248-501/000-017</b> Mini-WSB marking card; as card; not stretchable; plain; snap-on type</p>	<a href="http://www.wago.com/248-501/000-017">www.wago.com/248-501/000-017</a>
	<p><b>Item no.: 248-501/000-023</b> Mini-WSB marking card; as card; not stretchable; plain; snap-on type</p>	<a href="http://www.wago.com/248-501/000-023">www.wago.com/248-501/000-023</a>

	<b>Item no.: 248-501/000-024</b> Mini-WSB marking card; as card; not stretchable; plain; snap-on type	<a href="http://www.wago.com/248-501/000-024">www.wago.com/248-501/000-024</a>
	<b>Item no.: 709-177</b> Marking strips; on reel; 7.5 mm wide; not stretchable; plain; snap-on type	<a href="http://www.wago.com/709-177">www.wago.com/709-177</a>
	<b>Item no.: 709-178</b> Marking strips; on reel; 7.5 mm wide; not stretchable; plain; snap-on type	<a href="http://www.wago.com/709-178">www.wago.com/709-178</a>
	<b>Item no.: 709-196</b> Marking strips; for laser printer	<a href="http://www.wago.com/709-196">www.wago.com/709-196</a>
	<b>Item no.: 793-501</b> WMB marking card; as card; not stretchable; plain; snap-on type	<a href="http://www.wago.com/793-501">www.wago.com/793-501</a>
	<b>Item no.: 793-501/000-002</b> WMB marking card; as card; not stretchable; plain; snap-on type	<a href="http://www.wago.com/793-501/000-002">www.wago.com/793-501/000-002</a>
	<b>Item no.: 793-501/000-005</b> WMB marking card; as card; not stretchable; plain; snap-on type	<a href="http://www.wago.com/793-501/000-005">www.wago.com/793-501/000-005</a>
	<b>Item no.: 793-501/000-006</b> WMB marking card; as card; not stretchable; plain; snap-on type	<a href="http://www.wago.com/793-501/000-006">www.wago.com/793-501/000-006</a>
	<b>Item no.: 793-501/000-007</b> WMB marking card; as card; not stretchable; plain; snap-on type	<a href="http://www.wago.com/793-501/000-007">www.wago.com/793-501/000-007</a>
	<b>Item no.: 793-501/000-012</b> WMB marking card; as card; not stretchable; plain; snap-on type	<a href="http://www.wago.com/793-501/000-012">www.wago.com/793-501/000-012</a>
	<b>Item no.: 793-501/000-017</b> WMB marking card; as card; not stretchable; plain; snap-on type	<a href="http://www.wago.com/793-501/000-017">www.wago.com/793-501/000-017</a>
	<b>Item no.: 793-501/000-023</b> WMB marking card; as card; not stretchable; plain; snap-on type	<a href="http://www.wago.com/793-501/000-023">www.wago.com/793-501/000-023</a>
	<b>Item no.: 793-501/000-024</b> WMB marking card; as card; not stretchable; plain; snap-on type	<a href="http://www.wago.com/793-501/000-024">www.wago.com/793-501/000-024</a>
	<b>Item no.: 793-5501</b> WMB marking card; as card; for terminal block width 5 - 17.5 mm; stretchable 5 - 5.2 mm; plain; snap-on type	<a href="http://www.wago.com/793-5501">www.wago.com/793-5501</a>
	<b>Item no.: 793-5501/000-002</b> WMB marking card; as card; for terminal block width 5 - 17.5 mm; stretchable 5 - 5.2 mm; plain; snap-on type	<a href="http://www.wago.com/793-5501/000-002">www.wago.com/793-5501/000-002</a>
	<b>Item no.: 793-5501/000-005</b> WMB marking card; as card; stretchable 5 - 5.2 mm; plain; snap-on type	<a href="http://www.wago.com/793-5501/000-005">www.wago.com/793-5501/000-005</a>



**Item no.: 793-5501/000-006**  
WMB marking card; as card; stretchable 5 - 5.2 mm; plain; snap-on type

[www.wago.com/793-5501/000-006](http://www.wago.com/793-5501/000-006)



**Item no.: 793-5501/000-007**  
WMB marking card; as card; stretchable 5 - 5.2 mm; plain; snap-on type

[www.wago.com/793-5501/000-007](http://www.wago.com/793-5501/000-007)



**Item no.: 793-5501/000-012**  
WMB marking card; as card; stretchable 5 - 5.2 mm; plain; snap-on type

[www.wago.com/793-5501/000-012](http://www.wago.com/793-5501/000-012)



**Item no.: 793-5501/000-017**  
WMB marking card; as card; stretchable 5 - 5.2 mm; plain; snap-on type

[www.wago.com/793-5501/000-017](http://www.wago.com/793-5501/000-017)



**Item no.: 793-5501/000-023**  
WMB marking card; as card; stretchable 5 - 5.2 mm; plain; snap-on type

[www.wago.com/793-5501/000-023](http://www.wago.com/793-5501/000-023)



**Item no.: 793-5501/000-024**  
WMB marking card; as card; stretchable 5 - 5.2 mm; plain; snap-on type

[www.wago.com/793-5501/000-024](http://www.wago.com/793-5501/000-024)

#### Insulation stop



**Item no.: 280-470**  
Insulation stop; 0.08 - 0.2 mm<sup>2</sup> "s" (0.14 mm<sup>2</sup> "f-st"); 5 pieces/strip

[www.wago.com/280-470](http://www.wago.com/280-470)



**Item no.: 280-471**  
Insulation stop; 0.25 - 0.5 mm<sup>2</sup>; 5 pieces/strip

[www.wago.com/280-471](http://www.wago.com/280-471)



**Item no.: 280-472**  
Insulation stop; 0.75 - 1 mm<sup>2</sup>; 5 pieces/strip

[www.wago.com/280-472](http://www.wago.com/280-472)

#### Jumper



**Item no.: 709-110**  
Wire commoning chain; insulated; 4 connections; 3 x 110 mm

[www.wago.com/709-110](http://www.wago.com/709-110)



**Item no.: 709-111**  
Wire commoning chain; insulated; 3 connections; 2 x 120 mm

[www.wago.com/709-111](http://www.wago.com/709-111)



**Item no.: 709-112**  
Wire commoning chain; insulated; 3 connections; 2 x 170 mm

[www.wago.com/709-112](http://www.wago.com/709-112)



**Item no.: 870-402**  
Push-in type jumper bar; insulated; 2-way; Nominal current 18 A

[www.wago.com/870-402](http://www.wago.com/870-402)



**Item no.: 870-403**  
Push-in type jumper bar; insulated; 3-way; Nominal current 18 A

[www.wago.com/870-403](http://www.wago.com/870-403)



**Item no.: 870-404**  
Push-in type jumper bar; insulated; 4-way; Nominal current 18 A















[www.wago.com/870-404](http://www.wago.com/870-404)



**Item no.: 870-405**  
Push-in type jumper bar; insulated; 5-way; Nominal current 18 A

[www.wago.com/870-405](http://www.wago.com/870-405)



	<b>Item no.: 870-405/011-000</b> Ready-made push-in type jumper bar; insulated; 3-way (1-3-5); Nominal current 18 A	<a href="http://www.wago.com/870-405/011-000">www.wago.com/870-405/011-000</a>
	<b>Item no.: 870-406</b> Push-in type jumper bar; insulated; 6-way; Nominal current 18 A	<a href="http://www.wago.com/870-406">www.wago.com/870-406</a>
	<b>Item no.: 870-407</b> Push-in type jumper bar; insulated; 7-way; Nominal current 18 A	<a href="http://www.wago.com/870-407">www.wago.com/870-407</a>
	<b>Item no.: 870-407/011-000</b> Ready-made push-in type jumper bar; insulated; 3-way (1-3-5); Nominal current 18 A	<a href="http://www.wago.com/870-407/011-000">www.wago.com/870-407/011-000</a>
	<b>Item no.: 870-408</b> Push-in type jumper bar; insulated; 8-way; Nominal current 18 A	<a href="http://www.wago.com/870-408">www.wago.com/870-408</a>
	<b>Item no.: 870-409</b> Push-in type jumper bar; insulated; 9-way; Nominal current 18 A	<a href="http://www.wago.com/870-409">www.wago.com/870-409</a>
	<b>Item no.: 870-409/011-000</b> Ready-made push-in type jumper bar; insulated; 3-way (1-3-5); Nominal current 18 A	<a href="http://www.wago.com/870-409/011-000">www.wago.com/870-409/011-000</a>
	<b>Item no.: 870-410</b> Push-in type jumper bar; insulated; 10-way; Nominal current 18 A	<a href="http://www.wago.com/870-410">www.wago.com/870-410</a>
	<b>Item no.: 870-433</b> Push-in type jumper bar; insulated; from 1 to 3; Nominal current 18 A	<a href="http://www.wago.com/870-433">www.wago.com/870-433</a>
	<b>Item no.: 870-434</b> Push-in type jumper bar; insulated; from 1 to 4; Nominal current 18 A	<a href="http://www.wago.com/870-434">www.wago.com/870-434</a>
	<b>Item no.: 870-435</b> Push-in type jumper bar; insulated; from 1 to 5; Nominal current 18 A	<a href="http://www.wago.com/870-435">www.wago.com/870-435</a>
	<b>Item no.: 870-436</b> Push-in type jumper bar; insulated; from 1 to 6; Nominal current 18 A	<a href="http://www.wago.com/870-436">www.wago.com/870-436</a>
	<b>Item no.: 870-437</b> Push-in type jumper bar; insulated; from 1 to 7; Nominal current 18 A	<a href="http://www.wago.com/870-437">www.wago.com/870-437</a>
	<b>Item no.: 870-438</b> Push-in type jumper bar; insulated; from 1 to 8; Nominal current 18 A	<a href="http://www.wago.com/870-438">www.wago.com/870-438</a>
	<b>Item no.: 870-439</b> Push-in type jumper bar; insulated; from 1 to 9; Nominal current 18 A	<a href="http://www.wago.com/870-439">www.wago.com/870-439</a>
	<b>Item no.: 870-440</b> Push-in type jumper bar; insulated; from 1 to 10; Nominal current 18 A	<a href="http://www.wago.com/870-440">www.wago.com/870-440</a>

**Protective Warning Marker**

	<b>Item no.: 280-405</b> Protective warning marker; with high-voltage symbol, black; for 5 terminal blocks	<a href="http://www.wago.com/280-405">www.wago.com/280-405</a>
------------------------------------------------------------------------------------	---------------------------------------------------------------------------------------------------------------	----------------------------------------------------------------

**assembling**



Item no.: 209-106

Mounting carrier; for isolated mounting on DIN 35 rails

[www.wago.com/209-106](http://www.wago.com/209-106)



Item no.: 249-101

Screwless end stop; 6 mm wide; for WMB markers

[www.wago.com/249-101](http://www.wago.com/249-101)

## Downloads

### Documentation

#### Bid Text

870-911	Oct 20, 2017	DOC 25.1 kB	Download
---------	--------------	----------------	----------

## smartDATA

### CAD data

3D Download 870-911	URL	Download
---------------------	-----	----------

Subject to changes.