

Data sheet | Item number: 880-901/999-940

2-conductor through terminal block; 4 mm²; with test port; without shield contact; center marking; for DIN-rail 35 x 15 and 35 x 7.5; CAGE CLAMP®

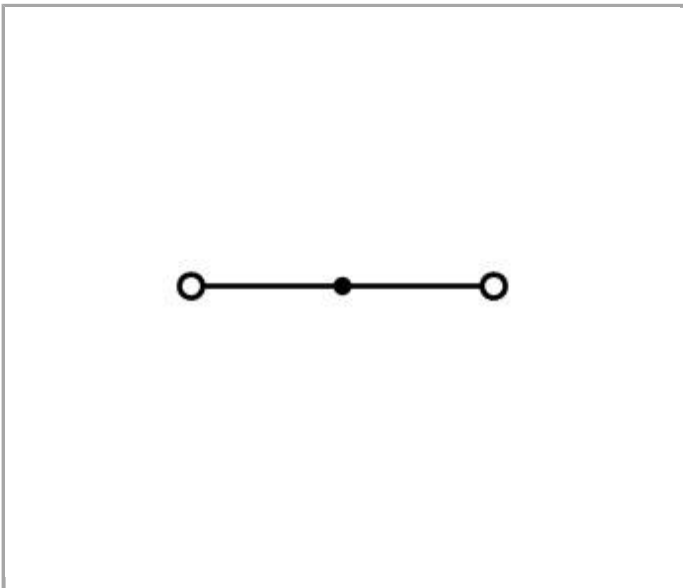

www.wago.com/880-901/999-940

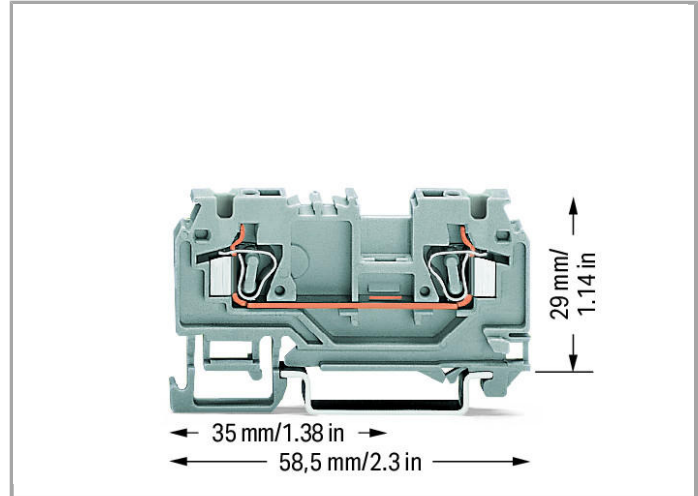
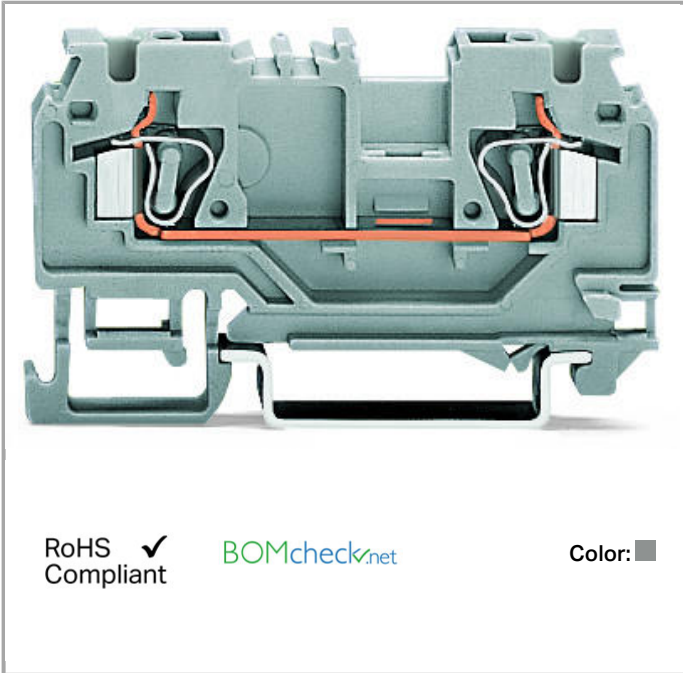

Data

Electrical data

Ratings per IEC/EN 60664-1

Rated voltage (III / 3)

800 V



Rated impulse voltage (III / 3)	8 kV
Rated current	25 A
Legend (ratings)	(III / 3) \triangleq Overvoltage category III / Pollution degree 3

Connection data

Connection technology	CAGE CLAMP®
Actuation type	Operating tool
Connectable conductor materials	Copper Aluminum
Solid conductor	0.08 ... 4 mm ² / 28 ... 12 AWG
Fine-stranded conductor	0.08 ... 4 mm ² / 28 ... 12 AWG
Strip length	8 ... 9 mm / 0.31 ... 0.35 Inch
Total number of connection points	2
Total number of potentials	1
Number of levels	1
Type of wiring	Front-entry wiring

Geometrical Data

Width	5 mm / 0.197 inch
Height from upper-edge of DIN-35 rail	29 mm / 1.142 inch
Depth	58.5 mm / 2.303 inch

Mechanical data

Design	horizontal
Type of mounting	DIN-35 rail
Marking level	Center marking

Material Data



Color	gray
Insulating material	Polyamide 66 (PA 66)
Fire load	0.12 MJ
Weight	6.473 g

Commercial data

Country of origin	PL
GTIN	4044918484688
Customs Tariff No.	85369010000
Product Group	1 (Rail Mounted Terminal Blocks)

Approvals / Certificates

Country specific Approvals

Logo	Approval	Certificate name
	CCA DEKRA Certification B.V.	2174152.01
	CCA DEKRA Certification B.V.	NTR-NL 7339

Ship Approvals



Logo	Approval	Certificate name
	ABS American Bureau of Shipping	14-HG1293677-PDA

UL-Approvals





Logo	Approval	Certificate name
	UL Underwriters Laboratories Inc.	E45172

Compatible products



assembling

	Item no.: 209-106 Mounting carrier; for isolated mounting on DIN 35 rails	www.wago.com/209-106
	Item no.: 709-153 Cover; Type 1; suitable for cover carrier, type 1; 1 m long	www.wago.com/709-153





General accessories

	Item no.: 249-105 Group marker carrier	www.wago.com/249-105
	Item no.: 280-404 Test plug adapter; 5 mm wide; for test plug 210-137 (2.3 mm Ø); suitable for 1.5 mm ² - 4 mm ² tbs	www.wago.com/280-404
	Item no.: 280-418 Test plug module; modular; suitable for all WAGO 280 and 780 Series rail-mounted terminal blocks with jumper slots in the current bar	www.wago.com/280-418
	Item no.: 280-419 Spacer module; modular; bridging commoned terminal blocks	www.wago.com/280-419
	Item no.: 281-407 Test plug; 6 mm wide; Nominal current 24 A; for 0.08 mm ² - 2.5 mm ²	www.wago.com/281-407









Insulation stop

	Item no.: 280-470 Insulation stop; 0.08 - 0.2 mm ² "s" (0.14 mm ² "f-st"); 5 pieces/strip	www.wago.com/280-470
	Item no.: 280-471 Insulation stop; 0.25 - 0.5 mm ² ; 5 pieces/strip	www.wago.com/280-471
	Item no.: 280-472 Insulation stop; 0.75 - 1 mm ² ; 5 pieces/strip	www.wago.com/280-472

check

	Item no.: 209-170 Test plug adapter; 8.3 mm wide; for 4 mm Ø test plugs; suitable for 1.5 mm ² - 10 mm ² tbs	www.wago.com/209-170
	Item no.: 210-136 Test plug; 2 mm Ø; with 500 mm cable	www.wago.com/210-136
	Item no.: 210-137 Test plug; 2.3 mm Ø; with 500 mm cable	www.wago.com/210-137
	Item no.: 249-106 B-type test plug module; modular	www.wago.com/249-106
	Item no.: 249-107 B-type spacer module; modular; e.g., for bridging commoned terminal blocks	www.wago.com/249-107

Carrier rail

	Item no.: 210-112 Steel carrier rail; 35 x 7.5 mm; 1 mm thick; 2 m long; slotted; according to EN 60715; "Hole width 25 mm	www.wago.com/210-112
	Item no.: 210-113 Steel carrier rail; 35 x 7.5 mm; 1 mm thick; 2 m long; unslotted; according to EN 60715	www.wago.com/210-113
	Item no.: 210-114 Steel carrier rail; 35 x 15 mm; 1.5 mm thick; 2 m long; unslotted; similar to EN 60715	www.wago.com/210-114
	Item no.: 210-115 Steel carrier rail; 35 x 7.5 mm; 1 mm thick; 2 m long; slotted; according to EN 60715; "Hole width 18 mm	www.wago.com/210-115
	Item no.: 210-118 Steel carrier rail; 35 x 15 mm; 2.3 mm thick; 2 m long; unslotted; according to EN 60715	www.wago.com/210-118
	Item no.: 210-196 Aluminum carrier rail; 35 x 8.2 mm; 1.6 mm thick; 2 m long; unslotted; similar to EN 60715	www.wago.com/210-196
	Item no.: 210-197 Steel carrier rail; 35 x 15 mm; 1.5 mm thick; 2 m long; slotted; similar to EN 60715	www.wago.com/210-197
	Item no.: 210-198 Copper carrier rail; 35 x 15 mm; 2.3 mm thick; 2 m long; unslotted; according to EN 60715	www.wago.com/210-198
	Item no.: 210-504 Steel carrier rail; 35 x 7.5 mm; 1 mm thick; 2 m long; slotted; galvanized; according to EN 60715	www.wago.com/210-504



Item no.: 210-505
Steel carrier rail; 35 x 7.5 mm; 1 mm thick; 2 m long; unslotted; galvanized; according to EN 60715

www.wago.com/210-505



Item no.: 210-506
Steel carrier rail; 35 x 15 mm; 1.5 mm thick; 2 m long; unslotted; galvanized; similar to EN 60715

www.wago.com/210-506



Item no.: 210-508
Steel carrier rail; 35 x 15 mm; 1.5 mm thick; 2 m long; slotted; galvanized; similar to EN 60715

www.wago.com/210-508

End plate



Item no.: 880-325
End and intermediate plate; 2.5 mm thick

www.wago.com/880-325



Item no.: 880-326
Separator plate; 2 mm thick; oversized

www.wago.com/880-326



Item no.: 880-328
End and intermediate plate; 2.5 mm thick

www.wago.com/880-328



Item no.: 880-329
Separator plate; 2 mm thick; oversized

www.wago.com/880-329

Jumper



Item no.: 210-103
Wire commoning chain; insulated; 50 connections

www.wago.com/210-103

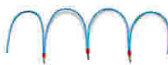

Item no.: 210-123
Wire commoning chain; insulated; 50 connections

www.wago.com/210-123



Item no.: 249-123
Push-in type wire jumper; insulated; wire length 180 mm; Conductor cross section 0.75 mm²

www.wago.com/249-123



Item no.: 249-125
Push-in type wire jumper; insulated; wire length 60 mm; Conductor cross section 0.75 mm²

www.wago.com/249-125



Item no.: 249-126
Push-in type wire jumper; insulated; wire length 110 mm; Conductor cross section 0.75 mm²

www.wago.com/249-126



Item no.: 249-127
Push-in type wire jumper; insulated; wire length 250 mm; Conductor cross section 0.75 mm²

www.wago.com/249-127



Item no.: 280-402
Adjacent jumper; insulated; IN = IN terminal block

www.wago.com/280-402



Item no.: 280-409
Alternate jumper; insulated; IN = IN terminal block

www.wago.com/280-409



Item no.: 280-422
Adjacent jumper; insulated; IN = IN terminal block

www.wago.com/280-422



Item no.: 709-110
Wire commoning chain; insulated; 4 connections; 3 x 110 mm

www.wago.com/709-110



Item no.: 709-111
Wire commoning chain; insulated; 3 connections; 2 x 120 mm

www.wago.com/709-111

Item no.: 709-112



Wire commoning chain; insulated; 3 connections; 2 x 170 mm

www.wago.com/709-112**Item no.: 780-452**

Staggered jumper; insulated; from 1 to 2; Spacing: 5 mm; suitable for 2-conductor female plugs

www.wago.com/780-452**Item no.: 780-453**

Staggered jumper; insulated; from 1 to 3; Spacing: 5 mm; suitable for 2-conductor female plugs

www.wago.com/780-453**Item no.: 780-454**

Staggered jumper; insulated; from 1 to 4; Spacing: 5 mm; suitable for 2-conductor female plugs

www.wago.com/780-454**Item no.: 780-455**

Staggered jumper; insulated; from 1 to 5; Spacing: 5 mm; suitable for 2-conductor female plugs

www.wago.com/780-455**Item no.: 780-456**

Staggered jumper; insulated; from 1 to 6; Spacing: 5 mm; suitable for 2-conductor female plugs

www.wago.com/780-456**Item no.: 780-457**

Staggered jumper; insulated; from 1 to 7; Spacing: 5 mm; suitable for 2-conductor female plugs

www.wago.com/780-457**Item no.: 780-458**

Staggered jumper; insulated; from 1 to 8; Spacing: 5 mm; suitable for 2-conductor female plugs

www.wago.com/780-458**ferrule****Item no.: 216-206**Ferrule; Sleeve for 2.5 mm² / AWG 14; insulated; electro-tin platedwww.wago.com/216-206**Marking accessories****Item no.: 2009-115**

WMB-Inline; for smartPRINTER; on reel; stretchable 5 - 5.2 mm; plain; snap-on type

www.wago.com/2009-115**Item no.: 2009-115/000-002**

WMB-Inline; for smartPRINTER; on reel; stretchable 5 - 5.2 mm; plain; snap-on type

www.wago.com/2009-115/000-002**Item no.: 2009-115/000-006**

WMB-Inline; for smartPRINTER; on reel; stretchable 5 - 5.2 mm; plain; snap-on type

www.wago.com/2009-115/000-006**Item no.: 2009-115/000-007**

WMB-Inline; for smartPRINTER; on reel; stretchable 5 - 5.2 mm; plain; snap-on type

www.wago.com/2009-115/000-007**Item no.: 2009-115/000-012**

WMB-Inline; for smartPRINTER; on reel; stretchable 5 - 5.2 mm; plain; snap-on type















www.wago.com/2009-115/000-012**Item no.: 2009-115/000-017**

WMB-Inline; for smartPRINTER; on reel; stretchable 5 - 5.2 mm; plain; snap-on type

www.wago.com/2009-115/000-017**Item no.: 2009-115/000-023**

WMB-Inline; for smartPRINTER; on reel; stretchable 5 - 5.2 mm; plain; snap-on type

www.wago.com/2009-115/000-023

	<p>Item no.: 2009-115/000-024 WMB-Inline; for smartPRINTER; on reel; stretchable 5 - 5.2 mm; plain; snap-on type</p>	www.wago.com/2009-115/000-024
	<p>Item no.: 2009-145 Mini-WSB Inline; for smartPRINTER; on reel; stretchable 5 - 5.2 mm; plain; snap-on type</p>	www.wago.com/2009-145
	<p>Item no.: 2009-145/000-002 Mini-WSB Inline; for smartPRINTER; on reel; stretchable 5 - 5.2 mm; plain; snap-on type</p>	www.wago.com/2009-145/000-002
	<p>Item no.: 2009-145/000-005 Mini-WSB Inline; for smartPRINTER; on reel; stretchable 5 - 5.2 mm; plain; snap-on type</p>	www.wago.com/2009-145/000-005
	<p>Item no.: 2009-145/000-006 Mini-WSB Inline; for smartPRINTER; on reel; stretchable 5 - 5.2 mm; plain; snap-on type</p>	www.wago.com/2009-145/000-006
	<p>Item no.: 2009-145/000-007 Mini-WSB Inline; for smartPRINTER; on reel; stretchable 5 - 5.2 mm; plain; snap-on type</p>	www.wago.com/2009-145/000-007
	<p>Item no.: 2009-145/000-012 Mini-WSB Inline; for smartPRINTER; on reel; stretchable 5 - 5.2 mm; plain; snap-on type</p>	www.wago.com/2009-145/000-012
	<p>Item no.: 2009-145/000-023 Mini-WSB Inline; for smartPRINTER; on reel; stretchable 5 - 5.2 mm; plain; snap-on type</p>	www.wago.com/2009-145/000-023
	<p>Item no.: 2009-145/000-024 Mini-WSB Inline; on reel; stretchable 5 - 5.2 mm; plain; snap-on type</p>	www.wago.com/2009-145/000-024
	<p>Item no.: 248-501 Miniature WSB Quick marking system; plain; Marker width 5 mm; 10 strips with 10 markers per card</p>	www.wago.com/248-501
	<p>Item no.: 248-501/000-002 Mini-WSB marking card; as card; not stretchable; plain; snap-on type</p>	www.wago.com/248-501/000-002
	<p>Item no.: 248-501/000-005 Mini-WSB marking card; as card; plain; snap-on type</p>	www.wago.com/248-501/000-005
	<p>Item no.: 248-501/000-006 Mini-WSB marking card; as card; not stretchable; plain; snap-on type</p>	www.wago.com/248-501/000-006
	<p>Item no.: 248-501/000-007 Mini-WSB marking card; as card; not stretchable; plain; snap-on type</p>	www.wago.com/248-501/000-007
	<p>Item no.: 248-501/000-012 Mini-WSB marking card; as card; not stretchable; plain; snap-on type</p>	www.wago.com/248-501/000-012



Item no.: 248-501/000-017
Mini-WSB marking card; as card; not stretchable; plain; snap-on type

www.wago.com/248-501/000-017



Item no.: 248-501/000-023
Mini-WSB marking card; as card; not stretchable; plain; snap-on type

www.wago.com/248-501/000-023



Item no.: 248-501/000-024
Mini-WSB marking card; as card; not stretchable; plain; snap-on type

www.wago.com/248-501/000-024



Item no.: 793-501
WMB marking card; as card; not stretchable; plain; snap-on type

www.wago.com/793-501



Item no.: 793-501/000-002
WMB marking card; as card; not stretchable; plain; snap-on type

www.wago.com/793-501/000-002



Item no.: 793-501/000-005
WMB marking card; as card; not stretchable; plain; snap-on type

www.wago.com/793-501/000-005



Item no.: 793-501/000-006
WMB marking card; as card; not stretchable; plain; snap-on type

www.wago.com/793-501/000-006



Item no.: 793-501/000-007
WMB marking card; as card; not stretchable; plain; snap-on type

www.wago.com/793-501/000-007



Item no.: 793-501/000-012
WMB marking card; as card; not stretchable; plain; snap-on type

www.wago.com/793-501/000-012



Item no.: 793-501/000-017
WMB marking card; as card; not stretchable; plain; snap-on type

www.wago.com/793-501/000-017



Item no.: 793-501/000-023
WMB marking card; as card; not stretchable; plain; snap-on type

www.wago.com/793-501/000-023



Item no.: 793-501/000-024
WMB marking card; as card; not stretchable; plain; snap-on type

www.wago.com/793-501/000-024



Item no.: 793-5501
WMB marking card; as card; for terminal block width 5 - 17.5 mm; stretchable 5 - 5.2 mm; plain; snap-on type

www.wago.com/793-5501



Item no.: 793-5501/000-002
WMB marking card; as card; for terminal block width 5 - 17.5 mm; stretchable 5 - 5.2 mm; plain; snap-on type

www.wago.com/793-5501/000-002



Item no.: 793-5501/000-005
WMB marking card; as card; stretchable 5 - 5.2 mm; plain; snap-on type

www.wago.com/793-5501/000-005



Item no.: 793-5501/000-006
WMB marking card; as card; stretchable 5 - 5.2 mm; plain; snap-on type

www.wago.com/793-5501/000-006



Item no.: 793-5501/000-007
WMB marking card; as card; stretchable 5 - 5.2 mm; plain; snap-on type

www.wago.com/793-5501/000-007



Item no.: 793-5501/000-012
WMB marking card; as card; stretchable 5 - 5.2 mm; plain; snap-on type

www.wago.com/793-5501/000-012



Item no.: 793-5501/000-017
WMB marking card; as card; stretchable 5 - 5.2 mm; plain; snap-on type

www.wago.com/793-5501/000-017



Item no.: 793-5501/000-023
WMB marking card; as card; stretchable 5 - 5.2 mm; plain; snap-on type

www.wago.com/793-5501/000-023



Item no.: 793-5501/000-024
WMB marking card; as card; stretchable 5 - 5.2 mm; plain; snap-on type

www.wago.com/793-5501/000-024

Protective Warning Marker



Item no.: 280-415
Protective warning marker; with high-voltage symbol, black; for 5 terminal blocks

www.wago.com/280-415

Downloads

Documentation

Bid Text

880-901/999-940	Oct 20, 2017	DOC 25.1 kB	Download
-----------------	--------------	----------------	----------

smartDATA

CAD data

3D Download 880-901/999-940	URL	Download
-----------------------------	-----	----------

Subject to changes.

WAGO Kontakttechnik GmbH & Co. KG
Hansastr. 27
32423 Minden
Phone: +49571 887-0 | Fax: +49571 887-169
Email: info.de@wago.com | Web: www.wago.com

Do you have any questions about our products?
We are always happy to take your call at +49 (571) 887-44222.