

Mounting Blocks

1110.300

Product Description

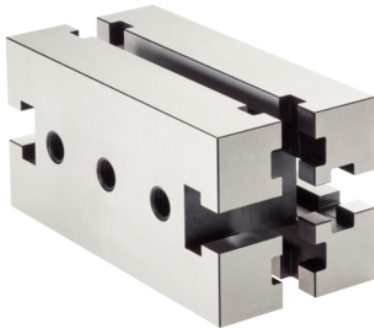

Material

- Steel, case-hardened, ground

Drawing

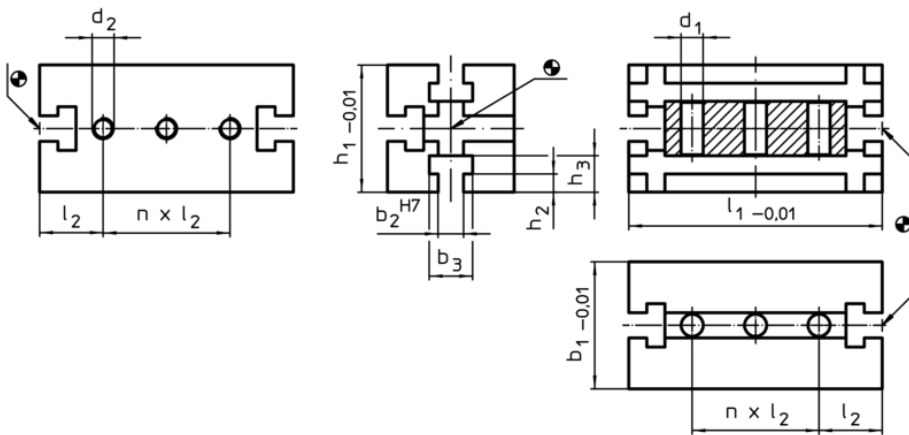

Order information

System	Dimensions										Amount n	[g]	Art. No.
	b_1	l_1	b_2	b_3	l_2	h_1	h_2	h_3	d_1	d_2			
V70	70	210	14	24	35	70	10	20	12,25	M12	4	5600	1110.300