

Intermediate Elements

1112.600

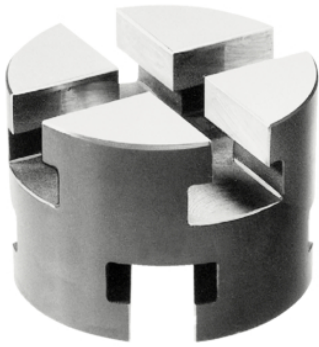

Product Description

Material

- Steel, case-hardened, ground

Drawing

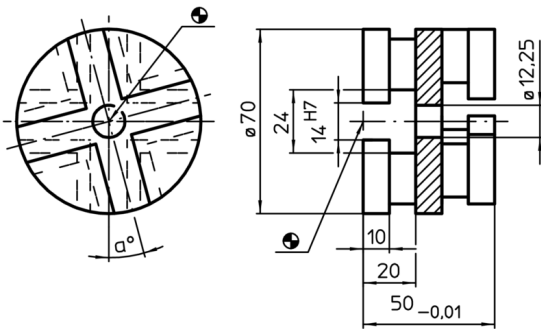

Order information

System	α	 [g]	Art. No.
V70	15°	800	1112.600