

Support Clamping Bars

1114.000

Product Description



Material

- Steel, case-hardened, ground

Drawing

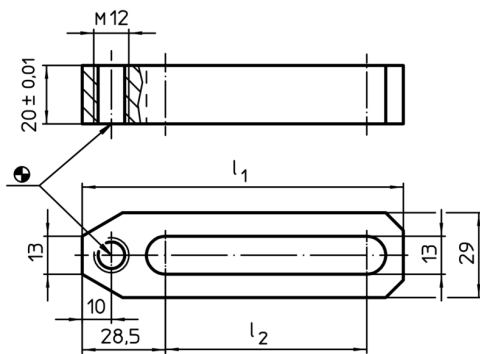

Order information

System	Dimensions		[g]	Art. No.
	l ₁	l ₂		
V70/L12	110	69	300	1114.000