

Fixed Drilling Supports

1162.000

Product Description

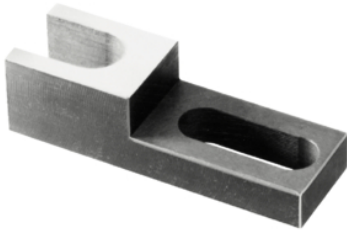

Material

- Steel, case-hardened, ground

Drawing

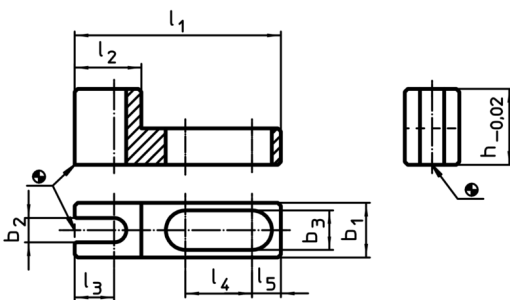

Order information

System	Dimensions										Art. No.
	l_1	l_2	l_3	l_4	l_5	b_1	b_2	b_3	h	[g]	
V70/L12	68	22	13	22	9,5	18	8	13	25	120	1162.000