

Fixed Drilling Supports • adjustable

1163.000

Product Description



Material

- Steel, case-hardened, ground

Drawing

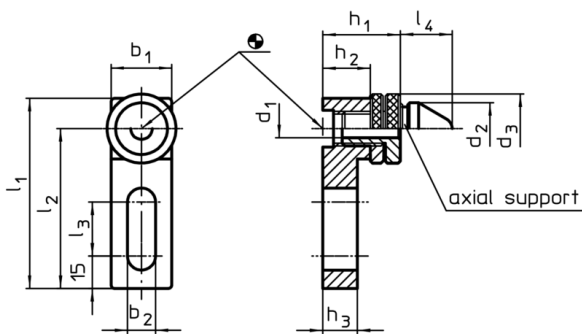

Order information

System	Dimensions												[g]	Art. No.
	b ₁	b ₂	d ₁	d ₂	d ₃	l ₁	l ₂	l ₃	l ₄	h ₁	h ₂	h ₃		
V70/L12	28	13	9,9	24	32	88	74	25	24	36 – 45	22	16	390	1163.000