

Fixed Drilling Supports • adjustable

1163.100

Product Description



Material

- Steel, case-hardened, ground

Drawing

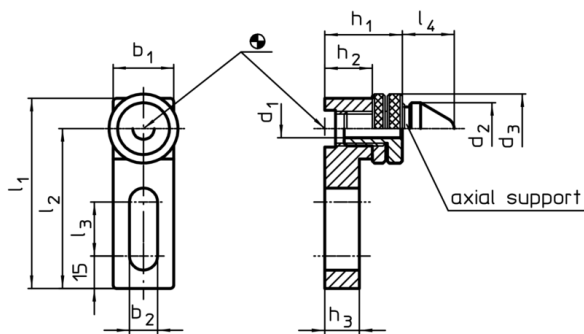

Order information

System	Dimensions												[g]	Art. No.
	b ₁	b ₂	d ₁	d ₂	d ₃	l ₁	l ₂	l ₃	l ₄	h ₁	h ₂	h ₃		
V70/L12	38	13	16,9	30	42	108	89	40	27	44 – 54	26	20	785	1163.100