

Fixed Drilling Supports • adjustable

1163.300

Product Description



Material

- Steel, case-hardened, ground

Drawing

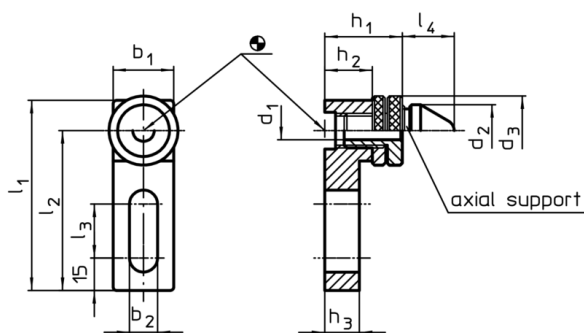

Order information

System	Dimensions												[g]	Art. No.
	b ₁	b ₂	d ₁	d ₂	d ₃	l ₁	l ₂	l ₃	l ₄	h ₁	h ₂	h ₃		
V70/L12	58	17	34,9	52	68	128	99	40	27	68 – 82	44	38	2550	1163.300