

Stop Angles

1621.600



Product Description

Material

- Grey cast iron, phosphatized, ground

Drawing

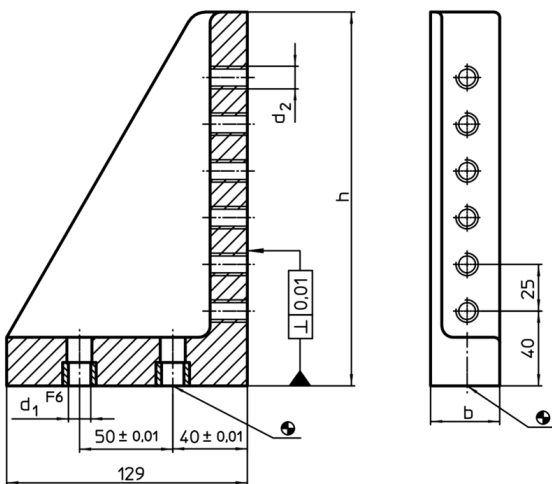

Order information

System	b	Dimensions			Number of threads	[g]	Art. No.
		h	d ₁	d ₂			
L16	66	140	16	M16	4	2900	1621.600