

Insertable Plates

1704.520



Product Description

- Three support heights
- For levelling the workpiece on the five-sided machining jaws
- Ground to high accuracy
- Supplied **without** M 6 x 8 mm mounting screws (Art. No. 1704.600)
- This product is supplied as a pair

Material

- Steel, hardened

Drawing

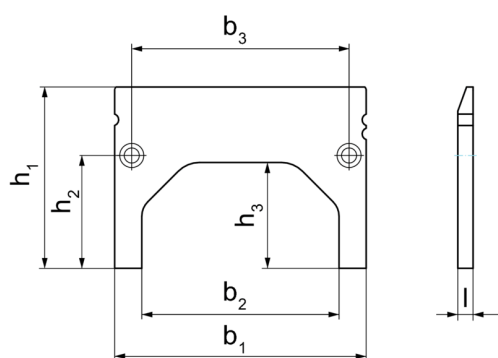

Order information

b ₁	b ₂	b ₃	Dimensions				[g]	Art. No.
			l	h ₁	h ₂	h ₃		
125	98	108	7,6	90	56	53	356	1704.520