

Ball Lock Pins with Button Handle- single acting - according to NASM / MS 17984

4210.C25



Product Description

Quick Release Pins according to NASM (former norm: MS) are used for quick fastening, locking, adjusting, changing and securing. Quickly and easily unlockable for frequently repeated connections.

Quick Release Pins (Single Acting Ball Lock Pins / Ball Lock Pins) are produced according to Aviation Norm NASM (former norm: MS) and tested to NAS 1332.

A standard program is available from stock (refer to article table). Delivery time for customer orders and dimensions not mentioned here currently 8 weeks. Please note the minimum order quantity of 20 pieces.

Material

Pin ①

- Stainless steel, precipitation-hardened, passivated

Press bolt ②

- Stainless steel, precipitation-hardened, passivated

Spring ③

- Stainless steel, precipitation-hardened, passivated

Handle ④

- Aluminium, black anodised

Attaching ring ⑤

- Stainless steel, passivated

Ball ⑥

- Stainless steel, precipitation-hardened, passivated

Operation

The balls are unlocked by pressing the knob.

More information

Notes

All further dimensions are available on request.

Special types on request.

Further products

- Ball Lock Pins, self-locking, with button handle
- Warning Streamers, according to NAS1756

Drawing

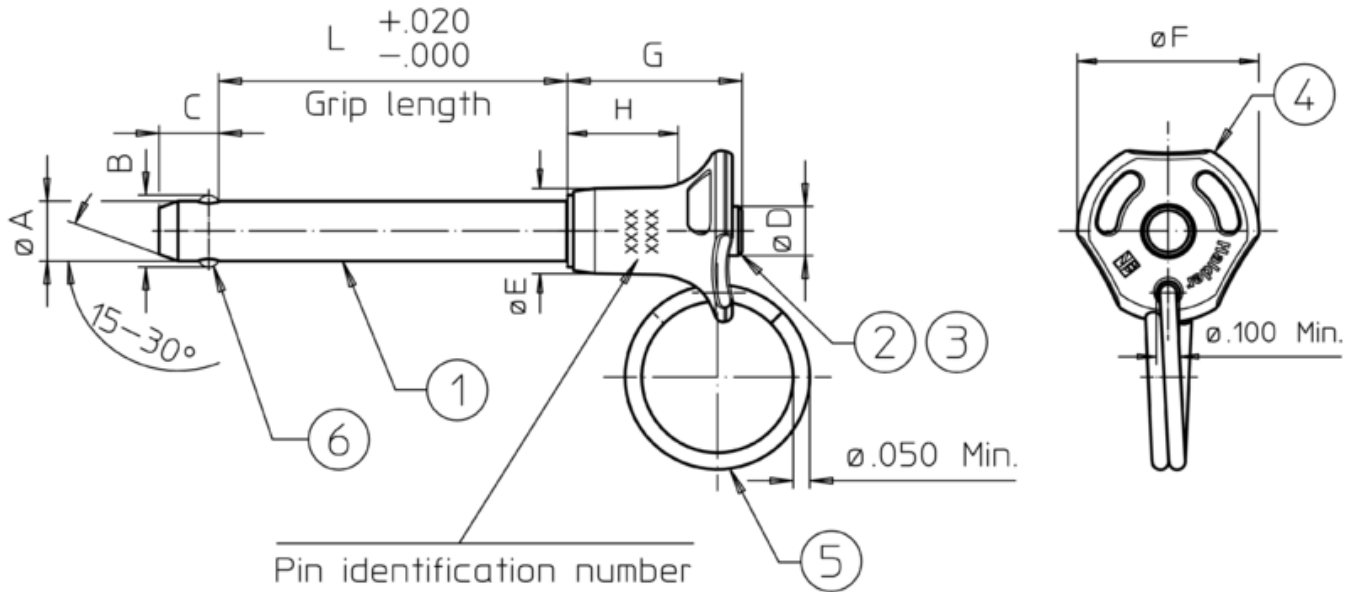

Pin identification number

Example:

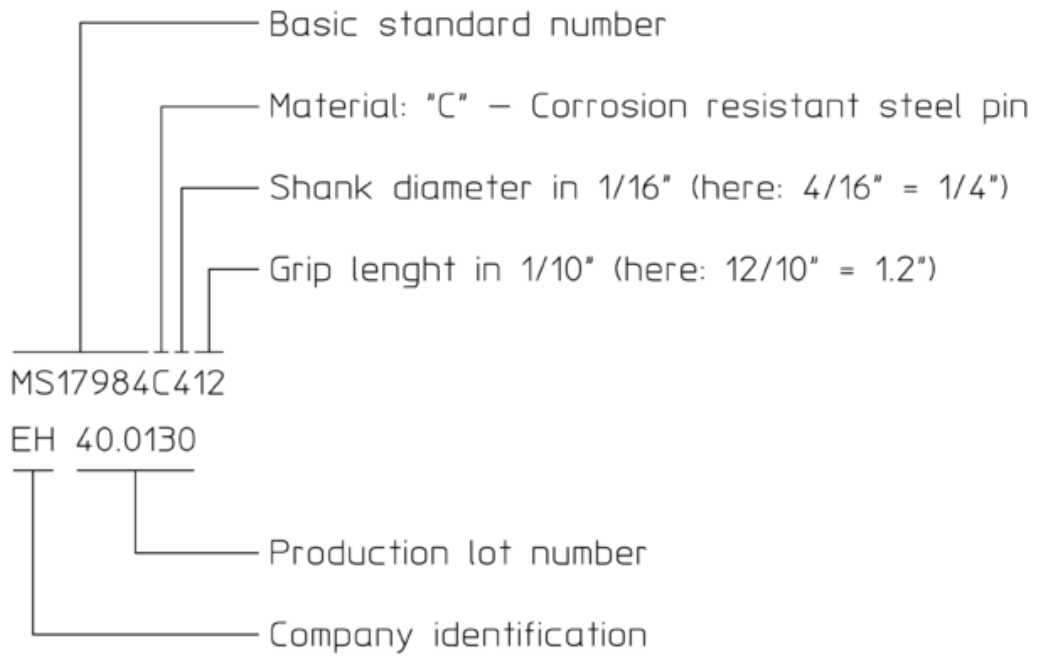

Ball positions may be different than shown in the drawing (rotation may be possible).

Order information

Nominal diameter A	Clamping Length L +0,02 0	B ±0,005	C 0 -0,04	Dimensions					Location hole max.	Shearing resistance, double ¹⁾ min.	Temperature		Weight [g]	Art. No.
				D max.	E max.	F max.	G max.	H min.			min.	max.		
[inch]	[inch]			[inch]					[inch]	[lb]	[°F]			
5/16	2,5	0,375	0,33	0,31	0,49	1,135	0,93	0,48	0,3165	14,400	-22	302	41	4210.C25

¹⁾ Shearing resistance similar to DIN 50141